

Circuit Diagram

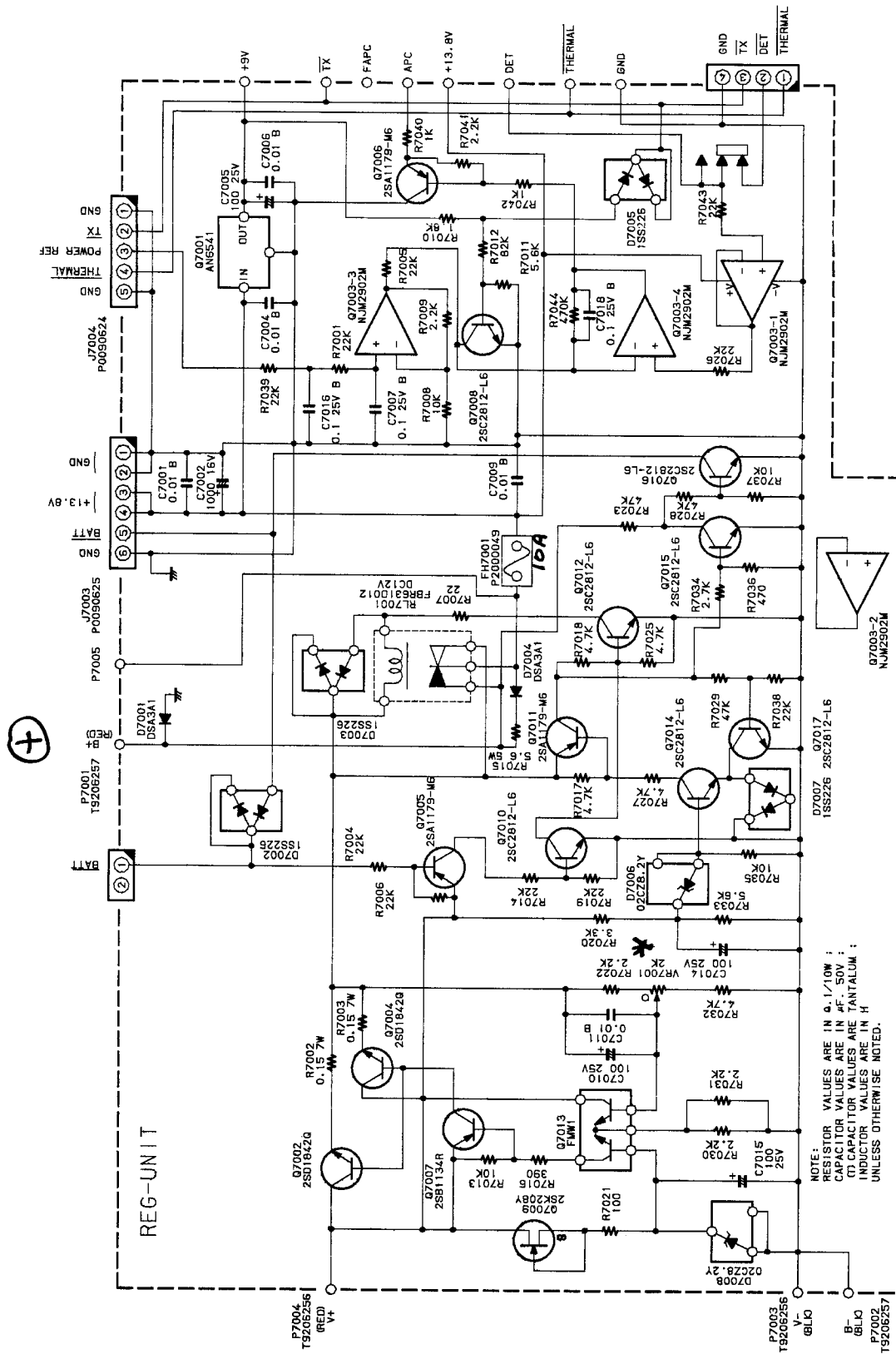

✚ ADJUST VR7001 FOR 13.8 ± 0.1 VDC AT ⊕ AND ⊖

REG UNIT

Parts Layout

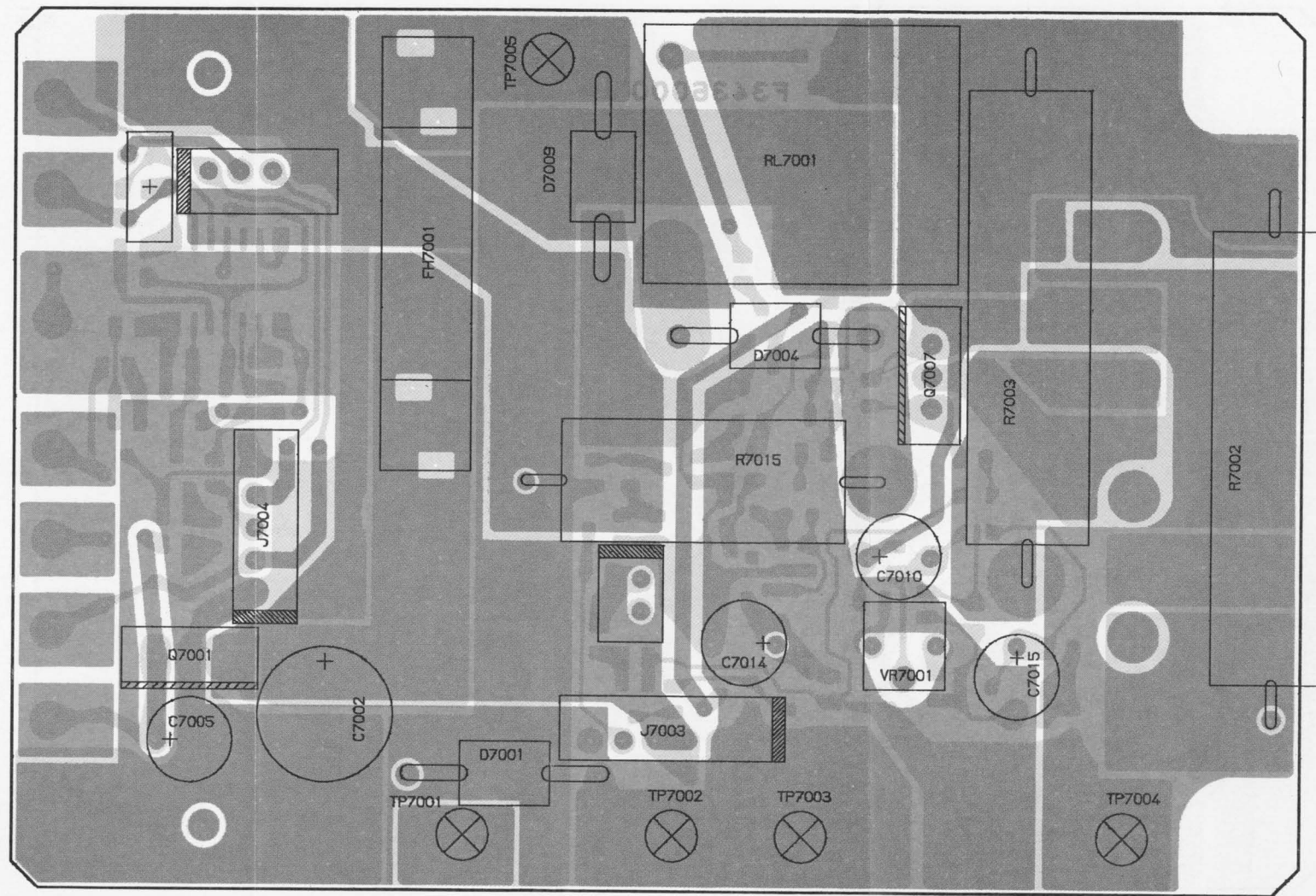
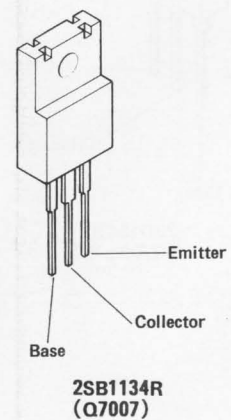
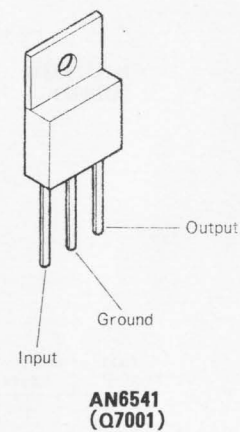

obverse view of component side

Parts Layout

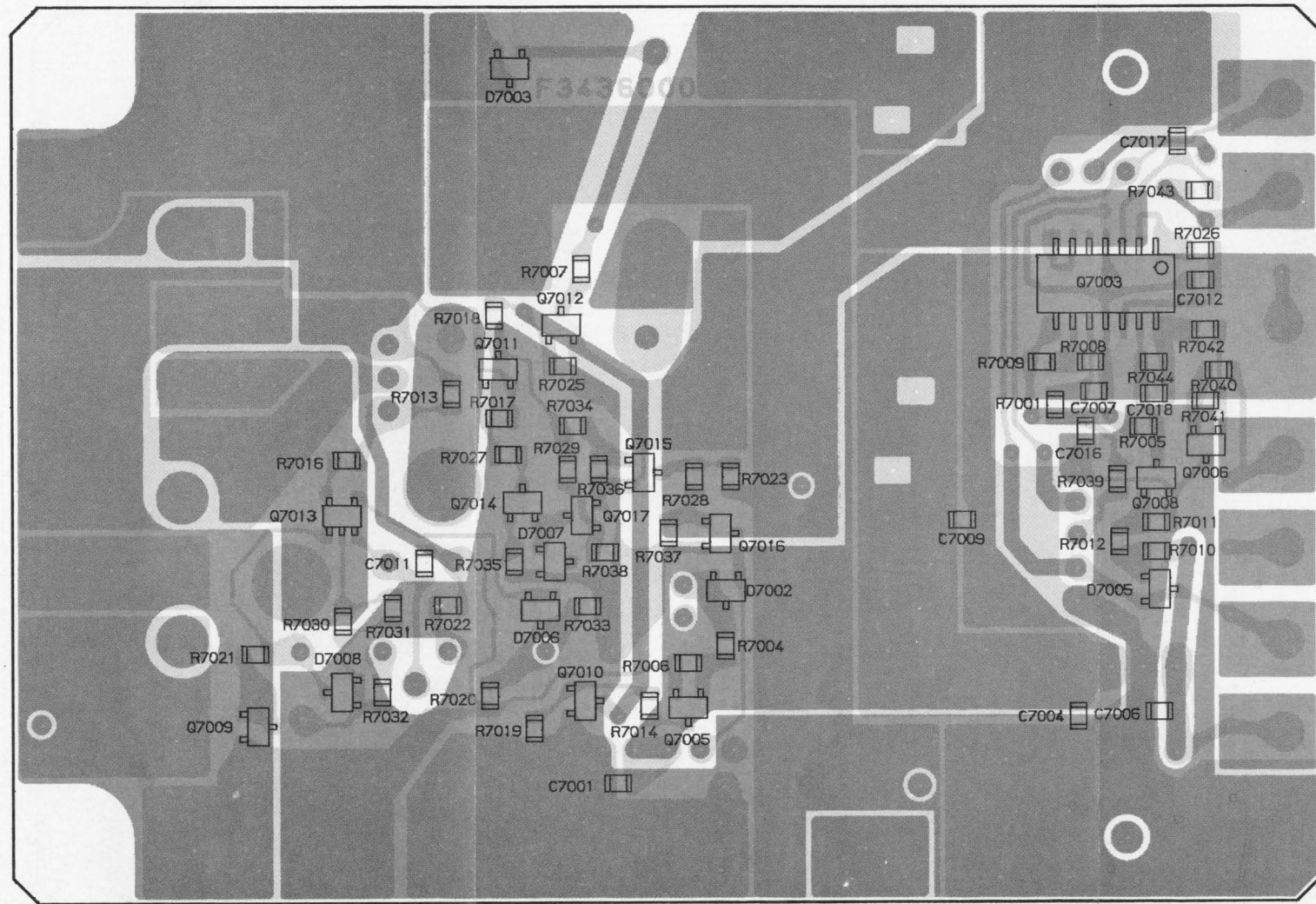

obverse view of chip side

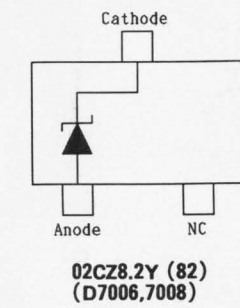
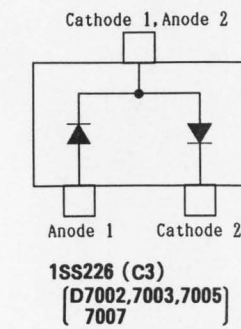
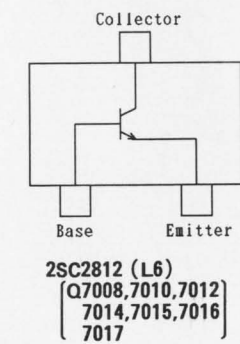
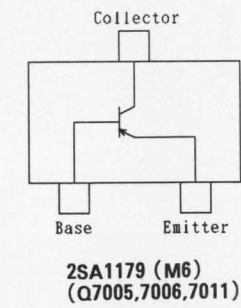
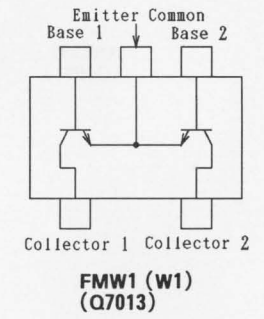
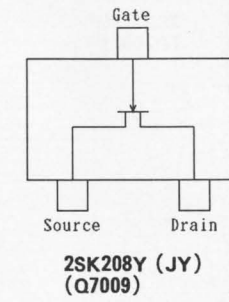
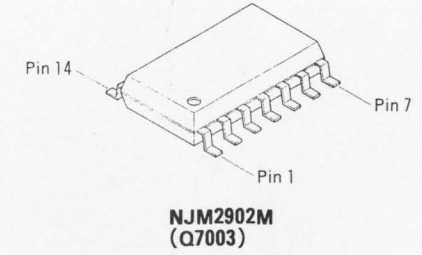
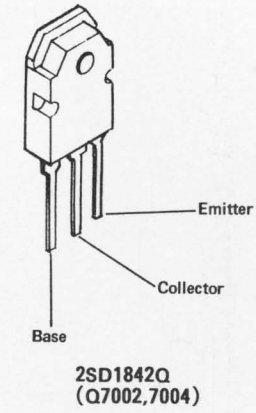

REF.	DESCRIPTION	VALUE	WV	TOL.	MFRG'S DESIG	YAESU P/N	VERS.	LOT.
*** REG UNIT ***								
	P.C.B. with Components (W/ Q7002, Q7004, THERMAL CONDUCTOR, W/O F7001)					CS1359001	VOL AC	
	P.C.B. with Components					CS1359002	VOL 13.8	
	Printed Circuit Board					F3436000		
C 7001	CHIP CAP.	0.01uF	50V	B	GRM40B103M50PT	K22170817		
C 7002	AL. ELECTRO. CAP.	1000uF	16V		RE3-16V102MS	K40129067		
C 7004	CHIP CAP.	0.01uF	50V	B	GRM40B103M50PT	K22170817		
C 7005	AL. ELECTRO. CAP.	100uF	25V		25V101M6X11TR5	K46140005		
C 7006	CHIP CAP.	0.01uF	50V	B	GRM40B103M50PT	K22170817		
C 7007	CHIP CAP.	0.1uF	25V	B	GRM40B104M25PT	K22140811		
C 7009	CHIP CAP.	0.01uF	50V	B	GRM40B103M50PT	K22170817		
C 7010	AL. ELECTRO. CAP.	100uF	25V		25V101M6X11TR5	K46140005	VOL AC	
C 7011	CHIP CAP.	0.01uF	50V	B	GRM40B103M50PT	K22170817	VOL AC	
C 7014	AL. ELECTRO. CAP.	100uF	25V		25V101M6X11TR5	K46140005	VOL AC	
C 7015	AL. ELECTRO. CAP.	100uF	25V		25V101M6X11TR5	K46140005	VOL AC	
C 7016	CHIP CAP.	0.1uF	25V	B	GRM40B104M25PT	K22140811		
C 7018	CHIP CAP.	0.1uF	25V	B	GRM40B104M25PT	K22140811		
D 7001	DIODE				DSA3A1	G2090445	VOL AC	
D 7002	DIODE				1SS226 TE85R	G2070003	VOL AC	
D 7003	DIODE				1SS226 TE85R	G2070003	VOL AC	
D 7004	DIODE				DSA3A1	G2090445	VOL AC	
D 7005	DIODE				1SS226 TE85R	G2070003		
D 7006	DIODE				02CZ8.2Y TE85R	G2070146	VOL AC	
D 7007	DIODE				1SS226 TE85R	G2070003	VOL AC	
D 7008	DIODE				02CZ8.2Y TE85R	G2070146	VOL AC	
D 7009	DIODE				DSA3A1	G2090445	VOL 13.8	
F 7001	FUSE				10A	Q0000007		
FH7001	FUSE CLIP (2pcs)				HC1	P2000049		
J 7003	CONNECTOR				SC25-06WS	P0090625		
J 7004	CONNECTOR				SC25-05WS	P0090624		
P 7001	WIRE-ASSY					T9206257		
P 7003	WIRE-ASSY					T9206256	VOL AC	
Q 7001	IC				AN6541	G1091146		
Q 7002	TRANSISTOR				2SD1842Q	G3418420Q	VOL AC	
Q 7003	IC				NJM2902M-T2	G1090908		
Q 7004	TRANSISTOR				2SD1842Q	G3418420Q	VOL AC	
Q 7005	TRANSISTOR				2SA1179M6-TA	G3111797F	VOL AC	
Q 7006	TRANSISTOR				2SA1179M6-TA	G3111797F		
Q 7007	TRANSISTOR				2SB1134R	G3211340R	VOL AC	
Q 7008	TRANSISTOR				2SC2812L6-TA	G3328127F		
Q 7009	FET				2SK208Y TE85R	G3802087Y	VOL AC	
Q 7010	TRANSISTOR				2SC2812L6-TA	G3328127F	VOL AC	

REG UNIT

REF.	DESCRIPTION	VALUE	WV	TOL.	MFGR'S DESIG	YAESU P/N	VERS.	LOT.
Q 7011	TRANSISTOR				2SA1179M6-TA	G3111797F	VOL AC	
Q 7012	TRANSISTOR				2SC2812L6-TA	G3328127F	VOL AC	
Q 7013	TRANSISTOR				FMW1 T98	G3070009	VOL AC	
Q 7014	TRANSISTOR				2SC2812L6-TA	G3328127F	VOL AC	
Q 7015	TRANSISTOR				2SC2812L6-TA	G3328127F	VOL AC	
Q 7016	TRANSISTOR				2SC2812L6-TA	G3328127F	VOL AC	
Q 7017	TRANSISTOR				2SC2812L6-TA	G3328127F	VOL AC	
R 7001	CHIP RES.	22K	1/10W	5%	RMC1/10T 223J	J24205223		
R 7002	CEMENT RES.	0.15	7W		RWBS7 0.15J	J30399001	VOL AC	
R 7003	CEMENT RES.	0.15	7W		RWBS7 0.15J	J30399001	VOL AC	
R 7004	CHIP RES.	22K	1/10W	5%	RMC1/10T 223J	J24205223	VOL AC	
R 7005	CHIP RES.	22K	1/10W	5%	RMC1/10T 223J	J24205223		
R 7006	CHIP RES.	22K	1/10W	5%	RMC1/10T 223J	J24205223	VOL AC	
R 7007	CHIP RES.	22	1/10W	5%	RMC1/10T 220J	J24205220	VOL AC	
R 7008	CHIP RES.	10K	1/10W	5%	RMC1/10T 103J	J24205103		
R 7009	CHIP RES.	2.2K	1/10W	5%	RMC1/10T 222J	J24205222		
R 7010	CHIP RES.	1.8K	1/10W	5%	RMC1/10T 182J	J24205182		
R 7011	CHIP RES.	5.6K	1/10W	5%	RMC1/10T 562J	J24205562		
R 7012	CHIP RES.	82K	1/10W	5%	RMC1/10T 823J	J24205823		
R 7013	CHIP RES.	10K	1/10W	5%	RMC1/10T 103J	J24205103	VOL AC	
R 7014	CHIP RES.	22K	1/10W	5%	RMC1/10T 223J	J24205223	VOL AC	
R 7015	CEMENT RES.	5.6	5W		ERF-5AK5R6	J30376569	VOL AC	
R 7016	CHIP RES.	390	1/10W	5%	RMC1/10T 391J	J24205391	VOL AC	
R 7017	CHIP RES.	4.7K	1/10W	5%	RMC1/10T 472J	J24205472	VOL AC	
R 7018	CHIP RES.	4.7K	1/10W	5%	RMC1/10T 472J	J24205472	VOL AC	
R 7019	CHIP RES.	22K	1/10W	5%	RMC1/10T 223J	J24205223	VOL AC	
R 7020	CHIP RES.	3.3K	1/10W	5%	RMC1/10T 332J	J24205332	VOL AC	
R 7021	CHIP RES.	100	1/10W	5%	RMC1/10T 101J	J24205101	VOL AC	
R 7022	CHIP RES.	2.2K	1/10W	5%	RMC1/10T 222J	J24205222	VOL AC	
R 7023	CHIP RES.	47K	1/10W	5%	RMC1/10T 473J	J24205473	VOL AC	
R 7025	CHIP RES.	4.7K	1/10W	5%	RMC1/10T 472J	J24205472	VOL AC	
R 7026	CHIP RES.	22K	1/10W	5%	RMC1/10T 223J	J24205223		
R 7027	CHIP RES.	4.7K	1/10W	5%	RMC1/10T 472J	J24205472	VOL AC	
R 7028	CHIP RES.	47K	1/10W	5%	RMC1/10T 473J	J24205473	VOL AC	
R 7029	CHIP RES.	47K	1/10W	5%	RMC1/10T 473J	J24205473	VOL AC	
R 7030	CHIP RES.	2.2K	1/10W	5%	RMC1/10T 222J	J24205222	VOL AC	
R 7031	CHIP RES.	2.2K	1/10W	5%	RMC1/10T 222J	J24205222	VOL AC	
R 7032	CHIP RES.	4.7K	1/10W	5%	RMC1/10T 472J	J24205472	VOL AC	
R 7033	CHIP RES.	5.6K	1/10W	5%	RMC1/10T 562J	J24205562	VOL AC	
R 7034	CHIP RES.	2.7K	1/10W	5%	RMC1/10T 272J	J24205272	VOL AC	
R 7035	CHIP RES.	10K	1/10W	5%	RMC1/10T 103J	J24205103	VOL AC	
R 7036	CHIP RES.	470	1/10W	5%	RMC1/10T 471J	J24205471	VOL AC	
R 7037	CHIP RES.	10K	1/10W	5%	RMC1/10T 103J	J24205103	VOL AC	
R 7038	CHIP RES.	22K	1/10W	5%	RMC1/10T 223J	J24205223	VOL AC	
R 7039	CHIP RES.	22K	1/10W	5%	RMC1/10T 223J	J24205223		
R 7040	CHIP RES.	1K	1/10W	5%	RMC1/10T 102J	J24205102		
R 7041	CHIP RES.	2.2K	1/10W	5%	RMC1/10T 222J	J24205222		
R 7042	CHIP RES.	1K	1/10W	5%	RMC1/10T 102J	J24205102		
R 7043	CHIP RES.	22K	1/10W	5%	RMC1/10T 223J	J24205223		
R 7044	CHIP RES.	470K	1/10W	5%	RMC1/10T 474J	J24205474		

REG UNIT

REF.	DESCRIPTION	VALUE	WV	TOL.	MFGR'S DESIG	YAESU P/N	VERS.	LOT.
RL7001	RELAY		DC12V		FBR631D012	M1190062	VOL AC	
VR7001	POT.	2K			EVN-DCAA03B23	J50784202	VOL AC	
	THERMAL CONDUCTOR (2pcs)				30-GSR-TO-3PF	Q9000609		