

Circuit Diagram

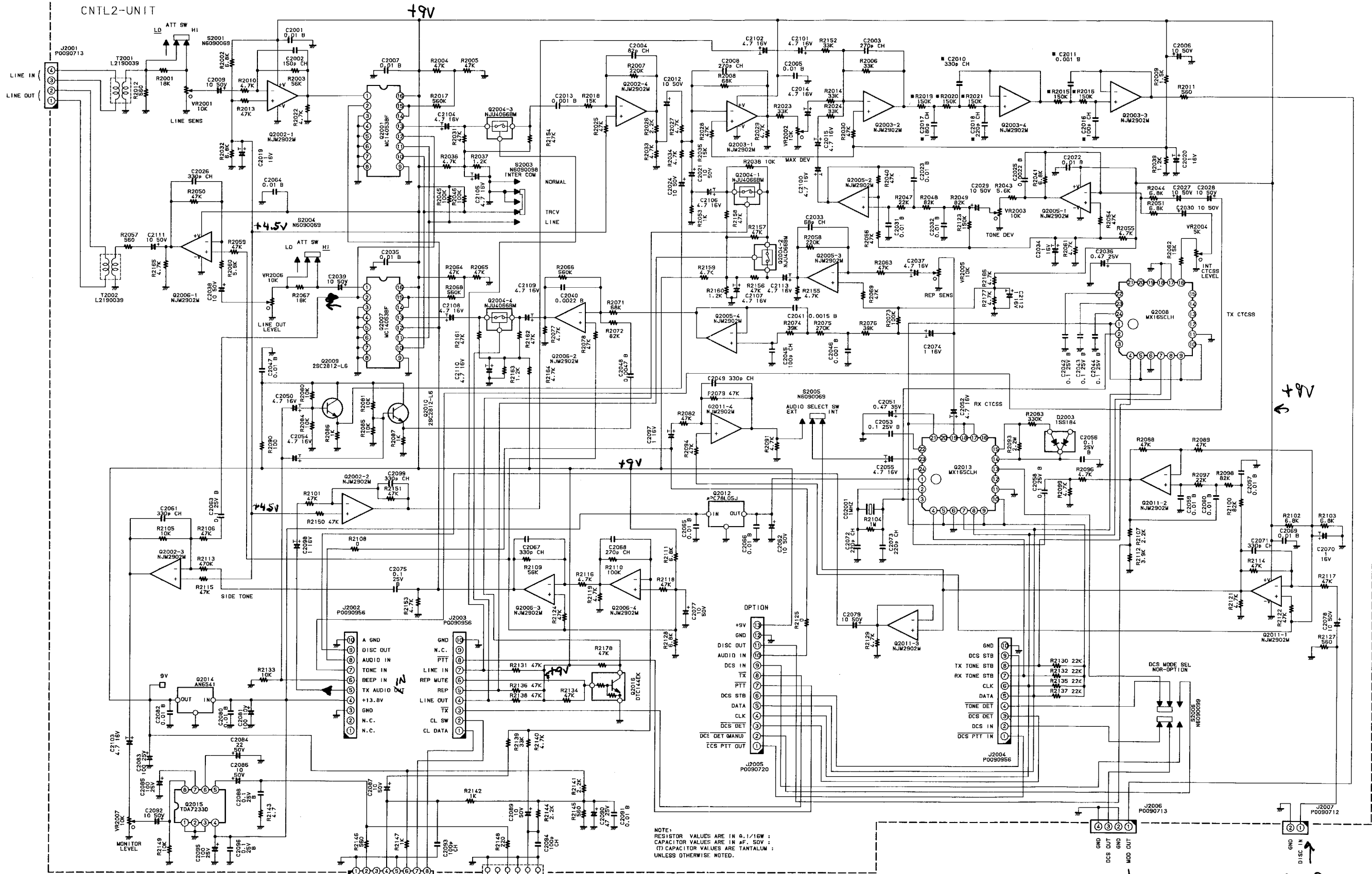

VR2005
ADJUSTS
TX DEV
TO MATCH
RX DEV

NOTE:
RESISTOR VALUES ARE IN Ω, 1/16W ;
CAPACITOR VALUES ARE IN μF, 50V ;
Ω CAPACITOR VALUES ARE TANTALUM ;
UNLESS OTHERWISE NOTED.

1. 9V
2. GND
3. GND
4. GND
5. GND
6. CL. SW
7. CL. DATA

PROGRAMMING
TASK

AUDIO
TO
X-MTR

AUDIO
FROM
RECEIVER

CNTL2 UNIT

Parts Layout

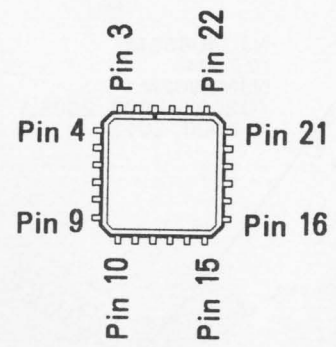
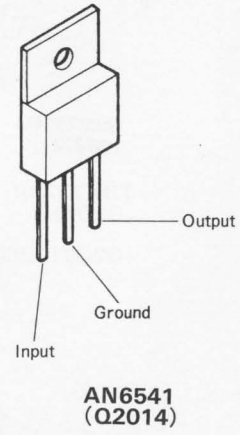

MX165CLH
(Q2008, 2013)

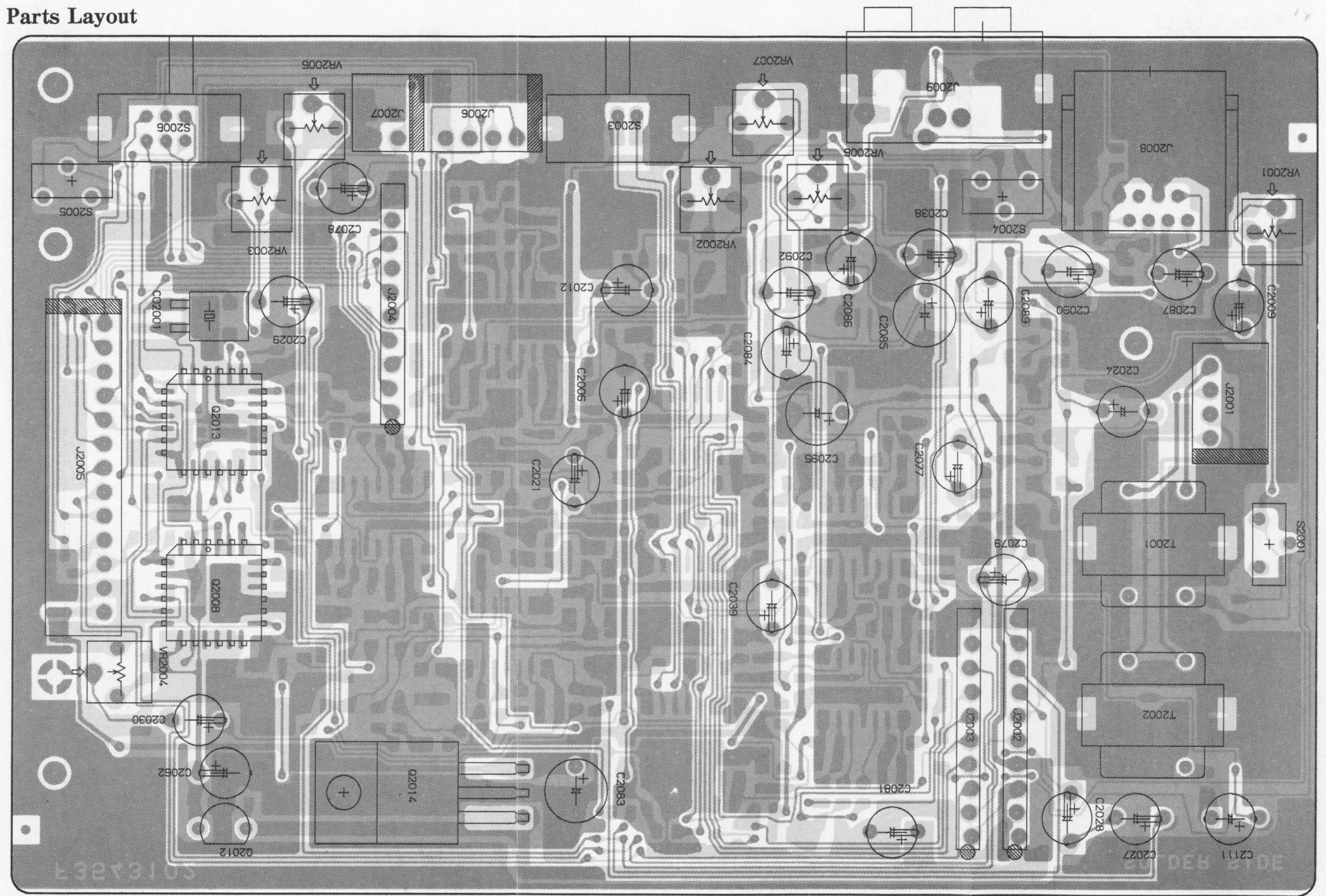
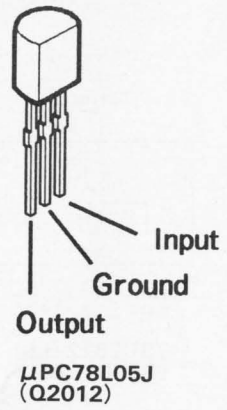

obverse view of component side

Parts Layout

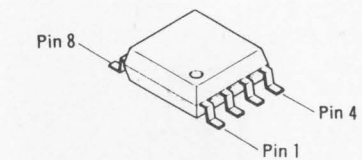
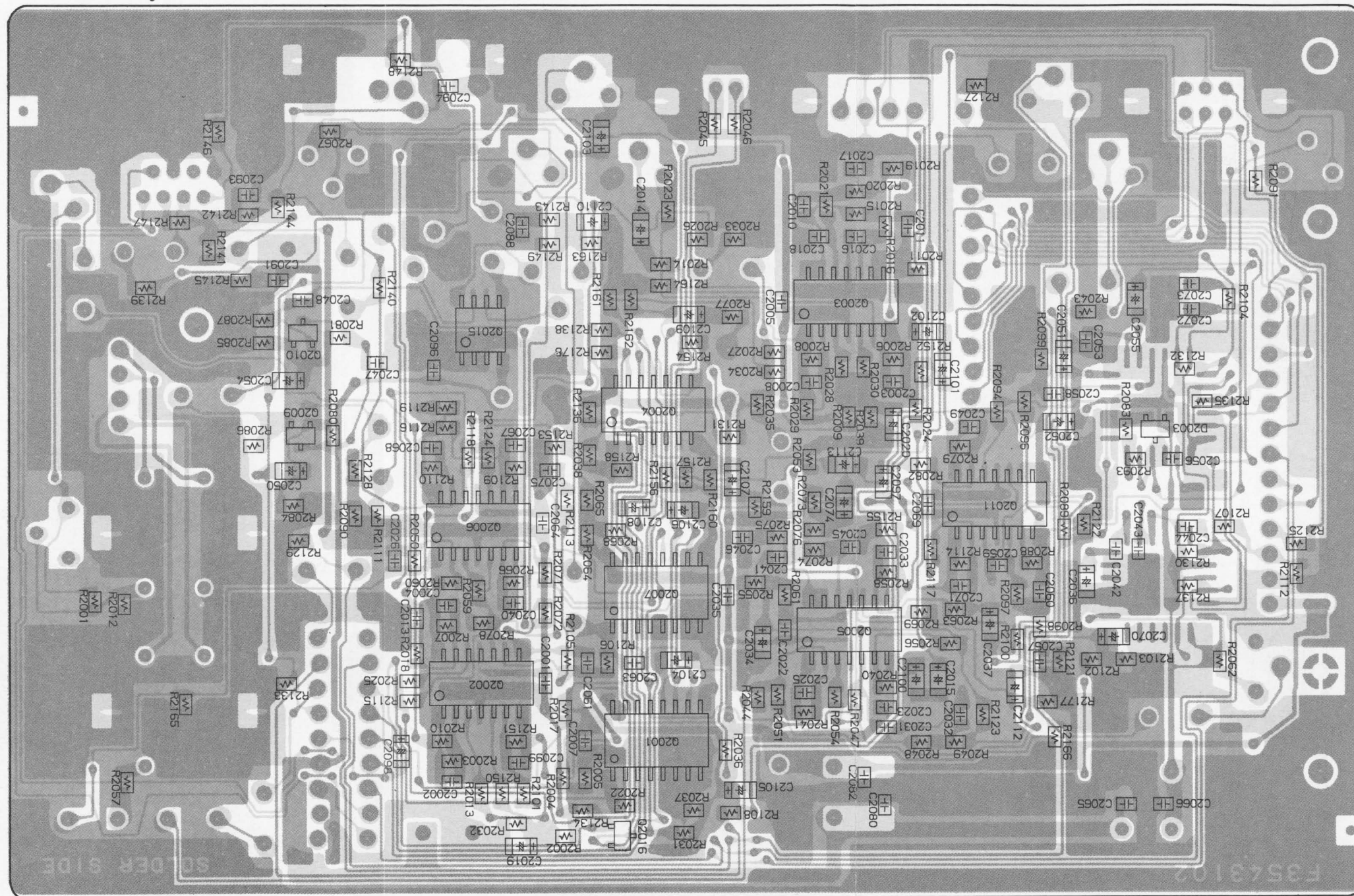

NJM2904M
(Q3002)

TDA7233P
(Q2015)
(Q2001, 2007)

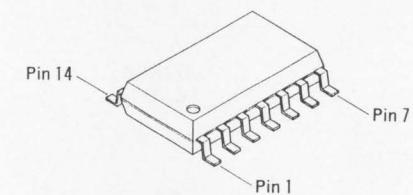

NJU4066BM
(Q2004)
NJM2902M
(Q2002, 2003, 2005,
2006, 2011)

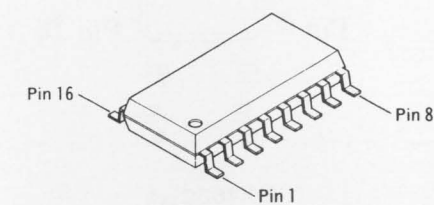

MC14053
(Q2001, 2007)

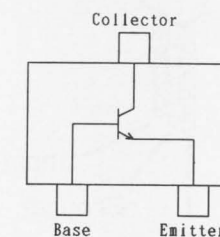

2SC2812 (L6)
(Q2009, 2010)

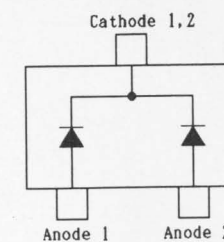

1SS184 (B3)
(D2003)

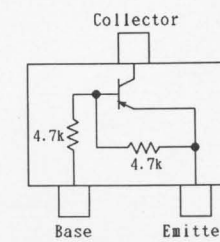

DTC144EK (26)
(Q2016)

obverse view of chip side

REF.	DESCRIPTION	VALUE	WV	TOL.	MFGR'S DESIG	YAESU P/N	VERS.	LOT.
*** CNTL2 UNIT ***								
	PCB with Components					CP5285001	SEP 25	
	PCB with Components					CP5285002	SEP 20	
	PCB with Components					CP5285003	SEP 12.5	
	Printed Circuit Board					F3543102		
C 2001	CHIP CAP.	0.01uF	50V	B	GRM40B103M50PT	K22170817		
C 2002	CHIP CAP.	150pF	50V	CH	GRM40CH151J50PT	K22170239		
C 2003	CHIP CAP.	150pF	50V	CH	GRM40CH151J50PT	K22170239		
C 2004	CHIP CAP.	82pF	50V	CH	GRM40CH820J50PT	K22170233		
C 2005	CHIP CAP.	0.01uF	50V	B	GRM40B103M50PT	K22170817		
C 2006	AL. ELECTRO. CAP.	10uF	50V		50V100M5X11TR5	K46170021		
C 2007	CHIP CAP.	0.01uF	50V	B	GRM40B103M50PT	K22170817		
C 2008	CHIP CAP.	47pF	50V	CH	GRM40CH470J50PT	K22170227		
C 2009	AL. ELECTRO. CAP.	10uF	50V		50V100M5X11TR5	K46170021		
C 2010	CHIP CAP.	470pF	50V	CH	GRM40CH471J50PT	K22170251	SEP 12.5	
C 2010	CHIP CAP.	470pF	50V	CH	GRM40CH471J50PT	K22170251	SEP 20	
C 2010	CHIP CAP.	330pF	50V	CH	GRM40CH331J50PT	K22170247	SEP 25	
C 2011	CHIP CAP.	820pF	50V	W5R	CM21W5R821K50AT	K22170829	SEP 12.5	
C 2011	CHIP CAP.	820pF	50V	W5R	CM21W5R821K50AT	K22170829	SEP 20	
C 2011	CHIP CAP.	0.001uF	50V	B	GRM40B102K50PT	K22170825	SEP 25	
C 2012	AL. ELECTRO. CAP.	10uF	50V		50V100M5X11TR5	K46170021		
C 2013	CHIP CAP.	0.001uF	50V	B	GRM40B102K50PT	K22170825		
C 2014	TANTALUM CHIP CAP.	4.7uF	16V		TEMSVA1C475M-8R	K78120031		
C 2015	TANTALUM CHIP CAP.	4.7uF	16V		TEMSVA1C475M-8R	K78120031		
C 2016	CHIP CAP.	68pF	50V	CH	GRM40CH680J50PT	K22170231	SEP 12.5	
C 2016	CHIP CAP.	68pF	50V	CH	GRM40CH680J50PT	K22170231	SEP 20	
C 2016	CHIP CAP.	100pF	50V	CH	GRM40CH101J50PT	K22170235	SEP 25	
C 2017	CHIP CAP.	330pF	50V	CH	GRM40CH331J50PT	K22170247	SEP 12.5	
C 2017	CHIP CAP.	330pF	50V	CH	GRM40CH331J50PT	K22170247	SEP 20	
C 2017	CHIP CAP.	180pF	50V	CH	GRM40CH181J50PT	K22170241	SEP 25	
C 2018	CHIP CAP.	100pF	50V	CH	GRM40CH101J50PT	K22170235	SEP 12.5	
C 2018	CHIP CAP.	100pF	50V	CH	GRM40CH101J50PT	K22170235	SEP 20	
C 2018	CHIP CAP.	220pF	50V	CH	GRM40CH221J50PT	K22170243	SEP 25	
C 2019	TANTALUM CHIP CAP.	1uF	16V		TESVA1C105M1-8R	K78120009		
C 2020	TANTALUM CHIP CAP.	1uF	16V		TESVA1C105M1-8R	K78120009		
C 2021	AL. ELECTRO. CAP.	10uF	50V		50V100M5X11TR5	K46170021		
C 2022	CHIP CAP.	0.01uF	50V	B	GRM40B103M50PT	K22170817		
C 2023	CHIP CAP.	0.01uF	50V	B	GRM40B103M50PT	K22170817		
C 2024	AL. ELECTRO. CAP.	10uF	50V		50V100M5X11TR5	K46170021		
C 2025	CHIP CAP.	0.0022uF	50V	B	GRM40B222M50PT	K22170809		
C 2026	CHIP CAP.	330pF	50V	CH	GRM40CH331J50PT	K22170247		
C 2027	AL. ELECTRO. CAP.	10uF	50V		50V100M5X11TR5	K46170021		
C 2028	AL. ELECTRO. CAP.	10uF	50V		50V100M5X11TR5	K46170021		
C 2029	AL. ELECTRO. CAP.	10uF	50V		50V100M5X11TR5	K46170021		
C 2030	AL. ELECTRO. CAP.	10uF	50V		50V100M5X11TR5	K46170021		
C 2031	CHIP CAP.	0.01uF	50V	B	GRM40B103M50PT	K22170817		
C 2032	CHIP CAP.	0.01uF	50V	B	GRM40B103M50PT	K22170817		
C 2033	CHIP CAP.	68pF	50V	CH	GRM40CH680J50PT	K22170231		
C 2034	TANTALUM CHIP CAP.	1uF	16V		TESVA1C105M1-8R	K78120009		

CNTL2 UNIT

REF.	DESCRIPTION	VALUE	WV	TOL.	MFGR'S DESIG	YAESU P/N	VERS.	LOT.
C 2035	CHIP CAP.	0.01uF	50V	B	GRM40B103M50PT	K22170817		
C 2036	TANTALUM CHIP CAP.	0.47uF	25V		TESVA1E474M1-8R	K78140009		
C 2037	TANTALUM CHIP CAP.	4.7uF	16V		TEMSVA1C475M-8R	K78120031		
C 2038	AL. ELECTRO. CAP.	10uF	50V		50V100M5X11TR5	K46170021		
C 2039	AL. ELECTRO. CAP.	10uF	50V		50V100M5X11TR5	K46170021		
C 2040	CHIP CAP.	0.0022uF	50V	B	GRM40B222M50PT	K22170809		
C 2041	CHIP CAP.	0.0015uF	50V	B	GRM40B152M50PT	K22170807		
C 2042	CHIP CAP.	0.1uF	25V	B	GRM40B104M25PT	K22140811		
C 2043	CHIP CAP.	0.1uF	25V	B	GRM40B104M25PT	K22140811		
C 2044	CHIP CAP.	0.1uF	25V	B	GRM40B104M25PT	K22140811		
C 2045	CHIP CAP.	100pF	50V	CH	GRM40CH101J50PT	K22170235		
C 2046	CHIP CAP.	0.001uF	50V	B	GRM40B102K50PT	K22170825		
C 2047	CHIP CAP.	0.01uF	50V	B	GRM40B103M50PT	K22170817		
C 2048	CHIP CAP.	0.0047uF	50V	B	GRM40B472M50PT	K22170813		
C 2049	CHIP CAP.	330pF	50V	CH	GRM40CH331J50PT	K22170247		
C 2050	TANTALUM CHIP CAP.	4.7uF	16V		ECST1CY475R	K78120039		
C 2051	TANTALUM CHIP CAP.	0.47uF	35V		TEMSVA1V474M-8R	K78160029		
C 2052	TANTALUM CHIP CAP.	4.7uF	16V		ECST1CY475R	K78120039		
C 2053	CHIP CAP.	0.1uF	25V	B	GRM40B104M25PT	K22140811		
C 2054	TANTALUM CHIP CAP.	4.7uF	16V		ECST1CY475R	K78120039		
C 2055	TANTALUM CHIP CAP.	4.7uF	16V		ECST1CY475R	K78120039		
C 2056	CHIP CAP.	0.1uF	25V	B	GRM40B104M25PT	K22140811		
C 2057	CHIP CAP.	0.01uF	50V	B	GRM40B103M50PT	K22170817		
C 2058	CHIP CAP.	0.1uF	25V	B	GRM40B104M25PT	K22140811		
C 2059	CHIP CAP.	0.01uF	50V	B	GRM40B103M50PT	K22170817		
C 2060	CHIP CAP.	0.01uF	50V	B	GRM40B103M50PT	K22170817		
C 2061	CHIP CAP.	330pF	50V	CH	GRM40CH331J50PT	K22170247		
C 2062	AL. ELECTRO. CAP.	10uF	50V		50V100M5X11TR5	K46170021		
C 2063	CHIP CAP.	0.1uF	25V	B	GRM40B104M25PT	K22140811		
C 2064	CHIP CAP.	0.01uF	50V	B	GRM40B103M50PT	K22170817		
C 2065	CHIP CAP.	0.01uF	50V	B	GRM40B103M50PT	K22170817		
C 2066	CHIP CAP.	0.01uF	50V	B	GRM40B103M50PT	K22170817		
C 2067	CHIP CAP.	330pF	50V	CH	GRM40CH331J50PT	K22170247		
C 2068	CHIP CAP.	270pF	50V	CH	GRM40CH271J50PT	K22170245		
C 2069	CHIP CAP.	0.01uF	50V	B	GRM40B103M50PT	K22170817		
C 2070	TANTALUM CHIP CAP.	1uF	16V		TESVA1C105M1-8R	K78120009		
C 2071	CHIP CAP.	330pF	50V	CH	GRM40CH331J50PT	K22170247		
C 2072	CHIP CAP.	220pF	50V	CH	GRM40CH221J50PT	K22170243		
C 2073	CHIP CAP.	220pF	50V	CH	GRM40CH221J50PT	K22170243		
C 2074	TANTALUM CHIP CAP.	1uF	16V		TESVA1C105M1-8R	K78120009		
C 2075	CHIP CAP.	0.1uF	25V	B	GRM40B104M25PT	K22140811		
C 2077	AL. ELECTRO. CAP.	10uF	50V		50V100M5X11TR5	K46170021		
C 2078	AL. ELECTRO. CAP.	10uF	50V		50V100M5X11TR5	K46170021		
C 2079	AL. ELECTRO. CAP.	10uF	50V		50V100M5X11TR5	K46170021		
C 2080	CHIP CAP.	0.01uF	50V	B	GRM40B103M50PT	K22170817		
C 2081	AL. ELECTRO. CAP.	100uF	10V		10V101M5X11TR5	K46100004		
C 2082	CHIP CAP.	0.01uF	50V	B	GRM40B103M50PT	K22170817		
C 2083	AL. ELECTRO. CAP.	100uF	25V		25V101M6X11TR5	K46140005		
C 2084	AL. ELECTRO. CAP.	22uF	50V		50V220M5X11TR5	K46170022		
C 2085	AL. ELECTRO. CAP.	100uF	25V		25V101M6X11TR5	K46140005		
C 2086	AL. ELECTRO. CAP.	10uF	50V		50V100M5X11TR5	K46170021		
C 2087	AL. ELECTRO. CAP.	10uF	50V		50V100M5X11TR5	K46170021		

CNTL2 UNIT

REF.	DESCRIPTION	VALUE	WV	TOL.	MFGR'S DESIG	YAESU P/N	VERS.	LOT.
C 2088	CHIP CAP.	0.1uF	25V	B	GRM40B104M25PT	K22140811		
C 2089	AL. ELECTRO. CAP.	10uF	50V		50V100M5X11TR5	K46170021		
C 2090	AL. ELECTRO. CAP.	47uF	25V		25V470M5X11TR5	K46140004		
C 2091	CHIP CAP.	0.01uF	50V	B	GRM40B103M50PT	K22170817		
C 2092	AL. ELECTRO. CAP.	10uF	50V		50V100M5X11TR5	K46170021		
C 2093	CHIP CAP.	100pF	50V	CH	GRM40CH101J50PT	K22170235		
C 2094	CHIP CAP.	100pF	50V	CH	GRM40CH101J50PT	K22170235		
C 2095	AL. ELECTRO. CAP.	100uF	25V		25V101M6X11TR5	K46140005		
C 2096	CHIP CAP.	0.1uF	25V	B	GRM40B104M25PT	K22140811		
C 2097	TANTALUM CHIP CAP.	1uF	16V		TESVA1C105M1-8R	K78120009		
C 2098	TANTALUM CHIP CAP.	1uF	16V		TESVA1C105M1-8R	K78120009		
C 2099	CHIP CAP.	330pF	50V	CH	GRM40CH331J50PT	K22170247		
C 2100	TANTALUM CHIP CAP.	4.7uF	16V		TEMSVA1C475M-8R	K78120031		
C 2101	TANTALUM CHIP CAP.	4.7uF	16V		TEMSVA1C475M-8R	K78120031		
C 2102	TANTALUM CHIP CAP.	4.7uF	16V		TEMSVA1C475M-8R	K78120031		
C 2103	TANTALUM CHIP CAP.	4.7uF	16V		ECST1CY475R	K78120039		
C 2104	TANTALUM CHIP CAP.	4.7uF	16V		ECST1CY475R	K78120039		
C 2105	TANTALUM CHIP CAP.	4.7uF	16V		ECST1CY475R	K78120039		
C 2106	TANTALUM CHIP CAP.	4.7uF	16V		ECST1CY475R	K78120039		
C 2107	TANTALUM CHIP CAP.	4.7uF	16V		ECST1CY475R	K78120039		
C 2108	TANTALUM CHIP CAP.	4.7uF	16V		ECST1CY475R	K78120039		
C 2109	TANTALUM CHIP CAP.	4.7uF	16V		ECST1CY475R	K78120039		
C 2110	TANTALUM CHIP CAP.	4.7uF	16V		ECST1CY475R	K78120039		
C 2111	AL. ELECTRO. CAP.	10uF	50V		50V100M5X11TR5	K46170021		
C 2112	TANTALUM CHIP CAP.	1uF	16V		TESVA1C105M1-8R	K78120009		
C 2113	TANTALUM CHIP CAP.	4.7uF	16V		ECST1CY475R	K78120039		
C 2114	CHIP CAP.	100pF	50V	CH	GRM40CH101J50PT	K22170235		
CO2001	CERAMIC OSC				CSB1000J221T	H7900550		
D 2003	DIODE				1SS184 TE85R	G2070009		
J 2001	CONNECTOR				SC25-04WL	P0090713		
J 2002	CONNECTOR				6027B-10Z103-T	P0090956		
J 2003	CONNECTOR				6027B-10Z103-T	P0090956		
J 2004	CONNECTOR				6027B-10Z103-T	P0090956		
J 2005	CONNECTOR				SC25-13WL	P0090720		
J 2006	CONNECTOR				SC25-04WL	P0090713		
J 2007	CONNECTOR				SC25-02WL	P0090712		
J 2008	CONNECTOR				R41-2736H	P1090677		
J 2009	CONNECTOR				HSJ1468-01-120	P1090691		
Q 2001	IC				MC14053BFR1	G1091524		
Q 2002	IC				NJM2902M-T2	G1090908		
Q 2003	IC				NJM2902M-T2	G1090908		
Q 2004	IC				NJU4066BM(T2)	G1091433		
Q 2005	IC				NJM2902M-T2	G1090908		
Q 2006	IC				NJM2902M-T2	G1090908		
Q 2007	IC				MC14053BFR1	G1091524		
Q 2008	IC				MX165CLH-TR	G1092010		
Q 2009	TRANSISTOR				2SC2812L6-TA	G3328127F		
Q 2010	TRANSISTOR				2SC2812L6-TA	G3328127F		

CNTL2 UNIT

REF.	DESCRIPTION	VALUE	WV	TOL.	MFR'S DESIG	YAESU P/N	VERS.	LOT.
Q 2011	IC				NJM2902M-T2	G1090908		
Q 2012	IC				UPC78L05J	G1090848		
Q 2013	IC				MX165CLH-TR	G1092010		
Q 2014	IC				AN6541	G1091146		
Q 2015	IC				TDA7233D-TR	G1091112		
Q 2016	TRANSISTOR				DTC144EK T147	G3070033		
R 2001	CHIP RES.	18K	1/10W	5%	RMC1/10T 183J	J24205183		
R 2002	CHIP RES.	6.8K	1/10W	5%	RMC1/10T 682J	J24205682		
R 2003	CHIP RES.	56K	1/10W	5%	RMC1/10T 563J	J24205563		
R 2004	CHIP RES.	47K	1/10W	5%	RMC1/10T 473J	J24205473		
R 2005	CHIP RES.	47K	1/10W	5%	RMC1/10T 473J	J24205473		
R 2006	CHIP RES.	68K	1/10W	5%	RMC1/10T 683J	J24205683		
R 2007	CHIP RES.	220K	1/10W	5%	RMC1/10T 224J	J24205224		
R 2008	CHIP RES.	68K	1/10W	5%	RMC1/10T 683J	J24205683		
R 2009	CHIP RES.	1.5K	1/10W	5%	RMC1/10T 152J	J24205152		
R 2010	CHIP RES.	4.7K	1/10W	5%	RMC1/10T 472J	J24205472		
R 2011	CHIP RES.	560	1/10W	5%	RMC1/10T 561J	J24205561		
R 2012	CHIP RES.	560	1/10W	5%	RMC1/10T 561J	J24205561		
R 2013	CHIP RES.	47K	1/10W	5%	RMC1/10T 473J	J24205473		
R 2014	CHIP RES.	33K	1/10W	5%	RMC1/10T 333J	J24205333		
R 2015	CHIP RES.	220K	1/10W	5%	RMC1/10T 224J	J24205224	SEP 12.5	
R 2015	CHIP RES.	180K	1/10W	5%	RMC1/10T 184J	J24205184	SEP 20	
R 2015	CHIP RES.	150K	1/10W	5%	RMC1/10T 154J	J24205154	SEP 25	
R 2016	CHIP RES.	220K	1/10W	5%	RMC1/10T 224J	J24205224	SEP 12.5	
R 2016	CHIP RES.	180K	1/10W	5%	RMC1/10T 184J	J24205184	SEP 20	
R 2016	CHIP RES.	150K	1/10W	5%	RMC1/10T 154J	J24205154	SEP 25	
R 2017	CHIP RES.	560K	1/10W	5%	RMC1/10T 564J	J24205564		
R 2018	CHIP RES.	15K	1/10W	5%	RMC1/10T 153J	J24205153		
R 2019	CHIP RES.	220K	1/10W	5%	RMC1/10T 224J	J24205224	SEP 12.5	
R 2019	CHIP RES.	180K	1/10W	5%	RMC1/10T 184J	J24205184	SEP 20	
R 2019	CHIP RES.	150K	1/10W	5%	RMC1/10T 154J	J24205154	SEP 25	
R 2020	CHIP RES.	220K	1/10W	5%	RMC1/10T 224J	J24205224	SEP 12.5	
R 2020	CHIP RES.	180K	1/10W	5%	RMC1/10T 184J	J24205184	SEP 20	
R 2020	CHIP RES.	150K	1/10W	5%	RMC1/10T 154J	J24205154	SEP 25	
R 2021	CHIP RES.	220K	1/10W	5%	RMC1/10T 224J	J24205224	SEP 12.5	
R 2021	CHIP RES.	180K	1/10W	5%	RMC1/10T 184J	J24205184	SEP 20	
R 2021	CHIP RES.	150K	1/10W	5%	RMC1/10T 154J	J24205154	SEP 25	
R 2022	CHIP RES.	4.7K	1/10W	5%	RMC1/10T 472J	J24205472		
R 2023	CHIP RES.	33K	1/10W	5%	RMC1/10T 333J	J24205333		
R 2024	CHIP RES.	33K	1/10W	5%	RMC1/10T 333J	J24205333		
R 2025	CHIP RES.	47K	1/10W	5%	RMC1/10T 473J	J24205473		
R 2026	CHIP RES.	2.2K	1/10W	5%	RMC1/10T 222J	J24205222		
R 2027	CHIP RES.	4.7K	1/10W	5%	RMC1/10T 472J	J24205472		
R 2028	CHIP RES.	47K	1/10W	5%	RMC1/10T 473J	J24205473		
R 2029	CHIP RES.	4.7K	1/10W	5%	RMC1/10T 472J	J24205472		
R 2030	CHIP RES.	47K	1/10W	5%	RMC1/10T 473J	J24205473		
R 2031	CHIP RES.	47K	1/10W	5%	RMC1/10T 473J	J24205473		
R 2032	CHIP RES.	6.8K	1/10W	5%	RMC1/10T 682J	J24205682		
R 2033	CHIP RES.	4.7K	1/10W	5%	RMC1/10T 472J	J24205472		
R 2034	CHIP RES.	4.7K	1/10W	5%	RMC1/10T 472J	J24205472		
R 2035	CHIP RES.	15K	1/10W	5%	RMC1/10T 153J	J24205153		

CNTL2 UNIT

REF.	DESCRIPTION	VALUE	WV	TOL.	MFGR'S DESIG	YAESU P/N	VERS.	LOT.
R 2036	CHIP RES.	4. 7K	1/10W	5%	RMC1/10T 472J	J24205472		
R 2037	CHIP RES.	1. 2K	1/10W	5%	RMC1/10T 122J	J24205122		
R 2038	CHIP RES.	10K	1/10W	5%	RMC1/10T 103J	J24205103		
R 2039	CHIP RES.	1. 2K	1/10W	5%	RMC1/10T 122J	J24205122		
R 2040	CHIP RES.	47K	1/10W	5%	RMC1/10T 473J	J24205473		
R 2041	CHIP RES.	6. 8K	1/10W	5%	RMC1/10T 682J	J24205682		
R 2043	CHIP RES.	5. 6K	1/10W	5%	RMC1/10T 562J	J24205562		
R 2044	CHIP RES.	6. 8K	1/10W	5%	RMC1/10T 682J	J24205682		
R 2045	CHIP RES.	100K	1/10W	5%	RMC1/10T 104J	J24205104		
R 2046	CHIP RES.	100K	1/10W	5%	RMC1/10T 104J	J24205104		
R 2047	CHIP RES.	22K	1/10W	5%	RMC1/10T 223J	J24205223		
R 2048	CHIP RES.	82K	1/10W	5%	RMC1/10T 823J	J24205823		
R 2049	CHIP RES.	82K	1/10W	5%	RMC1/10T 823J	J24205823		
R 2050	CHIP RES.	47K	1/10W	5%	RMC1/10T 473J	J24205473		
R 2051	CHIP RES.	3. 3K	1/10W	5%	RMC1/10T 332J	J24205332		
R 2053	CHIP RES.	1K	1/10W	5%	RMC1/10T 102J	J24205102		
R 2054	CHIP RES.	47K	1/10W	5%	RMC1/10T 473J	J24205473		
R 2055	CHIP RES.	4. 7K	1/10W	5%	RMC1/10T 472J	J24205472		
R 2056	CHIP RES.	47K	1/10W	5%	RMC1/10T 473J	J24205473		
R 2057	CHIP RES.	560	1/10W	5%	RMC1/10T 561J	J24205561		
R 2058	CHIP RES.	220K	1/10W	5%	RMC1/10T 224J	J24205224		
R 2059	CHIP RES.	47K	1/10W	5%	RMC1/10T 473J	J24205473		
R 2060	CHIP RES.	5. 6K	1/10W	5%	RMC1/10T 562J	J24205562		
R 2061	CHIP RES.	4. 7K	1/10W	5%	RMC1/10T 472J	J24205472		
R 2062	CHIP RES.	0	1/10W	5%	RMC1/10T 000J	J24205000		
R 2063	CHIP RES.	47K	1/10W	5%	RMC1/10T 473J	J24205473		
R 2064	CHIP RES.	47K	1/10W	5%	RMC1/10T 473J	J24205473		
R 2065	CHIP RES.	47K	1/10W	5%	RMC1/10T 473J	J24205473		
R 2066	CHIP RES.	560K	1/10W	5%	RMC1/10T 564J	J24205564		
R 2067	CHIP RES.	18K	1/10W	5%	RMC1/10T 183J	J24205183		
R 2068	CHIP RES.	560K	1/10W	5%	RMC1/10T 564J	J24205564		
R 2069	CHIP RES.	47K	1/10W	5%	RMC1/10T 473J	J24205473		
R 2071	CHIP RES.	68K	1/10W	5%	RMC1/10T 683J	J24205683		
R 2072	CHIP RES.	82K	1/10W	5%	RMC1/10T 823J	J24205823		
R 2073	CHIP RES.	100K	1/10W	5%	RMC1/10T 104J	J24205104		
R 2074	CHIP RES.	39K	1/10W	5%	RMC1/10T 393J	J24205393		
R 2075	CHIP RES.	270K	1/10W	5%	RMC1/10T 274J	J24205274		
R 2076	CHIP RES.	39K	1/10W	5%	RMC1/10T 393J	J24205393		
R 2077	CHIP RES.	4. 7K	1/10W	5%	RMC1/10T 472J	J24205472		
R 2078	CHIP RES.	47K	1/10W	5%	RMC1/10T 473J	J24205473		
R 2079	CHIP RES.	47K	1/10W	5%	RMC1/10T 473J	J24205473		
R 2080	CHIP RES.	10K	1/10W	5%	RMC1/10T 103J	J24205103		
R 2081	CHIP RES.	10K	1/10W	5%	RMC1/10T 103J	J24205103		
R 2082	CHIP RES.	47K	1/10W	5%	RMC1/10T 473J	J24205473		
R 2083	CHIP RES.	330K	1/10W	5%	RMC1/10T 334J	J24205334		
R 2084	CHIP RES.	10K	1/10W	5%	RMC1/10T 103J	J24205103		
R 2085	CHIP RES.	10K	1/10W	5%	RMC1/10T 103J	J24205103		
R 2086	CHIP RES.	1K	1/10W	5%	RMC1/10T 102J	J24205102		
R 2087	CHIP RES.	1K	1/10W	5%	RMC1/10T 102J	J24205102		
R 2088	CHIP RES.	47K	1/10W	5%	RMC1/10T 473J	J24205473		
R 2089	CHIP RES.	47K	1/10W	5%	RMC1/10T 473J	J24205473		
R 2090	CHIP RES.	100	1/10W	5%	RMC1/10T 101J	J24205101		

CNTL2 UNIT

REF.	DESCRIPTION	VALUE	WV	TOL.	MFGR'S DESIG	YAESU P/N	VERS.	LOT.
R 2091	CHIP RES.	4.7K	1/10W	5%	RMC1/10T 472J	J24205472		
R 2093	CHIP RES.	2.2M	1/10W	5%	RMC1/10T 225J	J24205225		
R 2094	CHIP RES.	47K	1/10W	5%	RMC1/10T 473J	J24205473		
R 2096	CHIP RES.	4.7K	1/10W	5%	RMC1/10T 472J	J24205472		
R 2097	CHIP RES.	22K	1/10W	5%	RMC1/10T 223J	J24205223		
R 2098	CHIP RES.	82K	1/10W	5%	RMC1/10T 823J	J24205823		
R 2099	CHIP RES.	4.7K	1/10W	5%	RMC1/10T 472J	J24205472		
R 2100	CHIP RES.	82K	1/10W	5%	RMC1/10T 823J	J24205823		
R 2101	CHIP RES.	47K	1/10W	5%	RMC1/10T 473J	J24205473		
R 2102	CHIP RES.	6.8K	1/10W	5%	RMC1/10T 682J	J24205682		
R 2103	CHIP RES.	6.8K	1/10W	5%	RMC1/10T 682J	J24205682		
R 2104	CHIP RES.	1M	1/10W	5%	RMC1/10T 105J	J24205105		
R 2105	CHIP RES.	10K	1/10W	5%	RMC1/10T 103J	J24205103		
R 2106	CHIP RES.	47K	1/10W	5%	RMC1/10T 473J	J24205473		
R 2107	CHIP RES.	2.2K	1/10W	5%	RMC1/10T 222J	J24205222		
R 2108	CHIP RES.	0	1/10W	5%	RMC1/10T 000J	J24205000		
R 2109	CHIP RES.	56K	1/10W	5%	RMC1/10T 563J	J24205563		
R 2110	CHIP RES.	100K	1/10W	5%	RMC1/10T 104J	J24205104		
R 2111	CHIP RES.	6.8K	1/10W	5%	RMC1/10T 682J	J24205682		
R 2112	CHIP RES.	3.9K	1/10W	5%	RMC1/10T 392J	J24205392		
R 2113	CHIP RES.	470K	1/10W	5%	RMC1/10T 474J	J24205474		
R 2114	CHIP RES.	47K	1/10W	5%	RMC1/10T 473J	J24205473		
R 2115	CHIP RES.	47K	1/10W	5%	RMC1/10T 473J	J24205473		
R 2116	CHIP RES.	4.7K	1/10W	5%	RMC1/10T 472J	J24205472		
R 2117	CHIP RES.	47K	1/10W	5%	RMC1/10T 473J	J24205473		
R 2118	CHIP RES.	47K	1/10W	5%	RMC1/10T 473J	J24205473		
R 2119	CHIP RES.	4.7K	1/10W	5%	RMC1/10T 472J	J24205472		
R 2121	CHIP RES.	4.7K	1/10W	5%	RMC1/10T 472J	J24205472		
R 2122	CHIP RES.	47K	1/10W	5%	RMC1/10T 473J	J24205473		
R 2123	CHIP RES.	150K	1/10W	5%	RMC1/10T 154J	J24205154		
R 2124	CHIP RES.	47K	1/10W	5%	RMC1/10T 473J	J24205473		
R 2125	CHIP RES.	0	1/10W	5%	RMC1/10T 000J	J24205000		
R 2127	CHIP RES.	560	1/10W	5%	RMC1/10T 561J	J24205561		
R 2128	CHIP RES.	6.8K	1/10W	5%	RMC1/10T 682J	J24205682		
R 2129	CHIP RES.	4.7K	1/10W	5%	RMC1/10T 472J	J24205472		
R 2130	CHIP RES.	22K	1/10W	5%	RMC1/10T 223J	J24205223		
R 2131	CHIP RES.	47K	1/10W	5%	RMC1/10T 473J	J24205473		
R 2132	CHIP RES.	22K	1/10W	5%	RMC1/10T 223J	J24205223		
R 2133	CHIP RES.	10K	1/10W	5%	RMC1/10T 103J	J24205103		
R 2134	CHIP RES.	47K	1/10W	5%	RMC1/10T 473J	J24205473		
R 2135	CHIP RES.	22K	1/10W	5%	RMC1/10T 223J	J24205223		
R 2136	CHIP RES.	47K	1/10W	5%	RMC1/10T 473J	J24205473		
R 2137	CHIP RES.	22K	1/10W	5%	RMC1/10T 223J	J24205223		
R 2138	CHIP RES.	47K	1/10W	5%	RMC1/10T 473J	J24205473		
R 2139	CHIP RES.	33K	1/10W	5%	RMC1/10T 333J	J24205333		
R 2140	CHIP RES.	4.7K	1/10W	5%	RMC1/10T 472J	J24205472		
R 2141	CHIP RES.	2.2K	1/10W	5%	RMC1/10T 222J	J24205222		
R 2142	CHIP RES.	1K	1/10W	5%	RMC1/10T 102J	J24205102		
R 2143	CHIP RES.	4.7	1/10W	5%	RMC1/10T 4R7J	J24205479		
R 2144	CHIP RES.	2.2K	1/10W	5%	RMC1/10T 222J	J24205222		
R 2145	CHIP RES.	560	1/10W	5%	RMC1/10T 561J	J24205561		
R 2146	CHIP RES.	8.2K	1/10W	5%	RMC1/10T 822J	J24205822		

CNTL2 UNIT

REF.	DESCRIPTION	VALUE	WV	TOL.	MFGR'S DESIG	YAESU P/N	VERS.	LOT.
R 2147	CHIP RES.	1K	1/10W	5%	RMC1/10T 102J	J24205102		
R 2148	CHIP RES.	220	1/10W	5%	RMC1/10T 221J	J24205221		
R 2149	CHIP RES.	10K	1/10W	5%	RMC1/10T 103J	J24205103		
R 2150	CHIP RES.	47K	1/10W	5%	RMC1/10T 473J	J24205473		
R 2151	CHIP RES.	47K	1/10W	5%	RMC1/10T 473J	J24205473		
R 2152	CHIP RES.	33K	1/10W	5%	RMC1/10T 333J	J24205333		
R 2153	CHIP RES.	4.7K	1/10W	5%	RMC1/10T 472J	J24205472		
R 2154	CHIP RES.	47K	1/10W	5%	RMC1/10T 473J	J24205473		
R 2155	CHIP RES.	4.7K	1/10W	5%	RMC1/10T 472J	J24205472		
R 2156	CHIP RES.	47K	1/10W	5%	RMC1/10T 473J	J24205473		
R 2157	CHIP RES.	47K	1/10W	5%	RMC1/10T 473J	J24205473		
R 2158	CHIP RES.	47K	1/10W	5%	RMC1/10T 473J	J24205473		
R 2159	CHIP RES.	4.7K	1/10W	5%	RMC1/10T 472J	J24205472		
R 2160	CHIP RES.	1.2K	1/10W	5%	RMC1/10T 122J	J24205122		
R 2161	CHIP RES.	47K	1/10W	5%	RMC1/10T 473J	J24205473		
R 2162	CHIP RES.	47K	1/10W	5%	RMC1/10T 473J	J24205473		
R 2163	CHIP RES.	1.2K	1/10W	5%	RMC1/10T 122J	J24205122		
R 2164	CHIP RES.	4.7K	1/10W	5%	RMC1/10T 472J	J24205472		
R 2165	CHIP RES.	4.7K	1/10W	5%	RMC1/10T 472J	J24205472		
R 2166	CHIP RES.	4.7K	1/10W	5%	RMC1/10T 472J	J24205472		
R 2177	CHIP RES.	4.7K	1/10W	5%	RMC1/10T 472J	J24205472		
R 2178	CHIP RES.	47K	1/10W	5%	RMC1/10T 473J	J24205473		
R 2179	CARBON FILM RES.	560	1/6W	5%	RD16PJ561	J01225561		
S 2001	SLIDE SWITCH				SSSS21	N6090069		
S 2003	SLIDE SWITCH				SSSF113-S06N1	N6090098		
S 2004	SLIDE SWITCH				SSSS21	N6090069		
S 2005	SLIDE SWITCH				SSSS21	N6090069		
S 2006	SLIDE SWITCH				SSSF122-S06N1	N6090099		
T 2001	TRANS.					L2190039		
T 2002	TRANS.					L2190039		
VR2001	POT.	10K			EVN-DCAA03B14	J50784103		
VR2002	POT.	10K			EVN-DCAA03B14	J50784103		
VR2003	POT.	10K			EVN-DCAA03B14	J50784103		
VR2004	POT.	5K			EVN-DCAA03B53	J50784502		
VR2005	POT.	10K			EVN-DCAA03B14	J50784103		
VR2006	POT.	10K			EVN-DCAA03B14	J50784103		
VR2007	POT.	10K			EVN-DCAA03B14	J50784103		

CNTL2 UNIT