



UHF FM Transceiver
VX-230 Series
 Service Manual

©2010 VERTEX STANDARD CO., LTD. EC085U90E

VERTEX STANDARD CO., LTD.
 4-8-8 Nakameguro, Meguro-Ku, Tokyo 153-8644, Japan

VERTEX STANDARD
US Headquarters
 10900 Walker Street, Cypress, CA 90630, U.S.A.

YAESU UK LTD.
 Unit 12, Sun Valley Business Park, Winnall Close
 Winchester, Hampshire, SO23 0LB, U.K.

VERTEX STANDARD HK LTD.
 Unit 5, 20/F., Seaview Centre, 139-141 Hoi Bun Road,
 Kwun Tong, Kowloon, Hong Kong

VERTEX STANDARD (AUSTRALIA) PTY., LTD.
 Normanby Business Park, Unit 14/45 Normanby Road
 Notting Hill 3168, Victoria, Australia

Introduction

This manual provides technical information necessary for servicing the **VX-230** FM Transceiver.

Servicing this equipment requires expertise in handling surface-mount chip components. Attempts by non-qualified persons to service this equipment may result in permanent damage not covered by the warranty, and may be illegal in some countries.

Two PCB layout diagrams are provided for each double-sided circuit board in the transceiver. Each side of is referred to by the type of the majority of components installed on that side (“leaded” or “chip-only”). In most cases one side has only chip components, and the other has either a mixture of both chip and leaded components (trimmers, coils, electrolytic capacitors, ICs, etc.), or leaded components only.

While we believe the technical information in this manual to be correct, VERTEX STANDARD assumes no liability for damage that may occur as a result of typographical or other errors that may be present. Your cooperation in pointing out any inconsistencies in the technical information would be appreciated.

Important Note

This transceiver was assembled using Pb (lead) free solder, based on the RoHS specification.

Only lead-free solder (Alloy Composition: Sn-3.0Ag-0.5Cu) should be used for repairs performed on this apparatus. The solder stated above utilizes the alloy composition required for compliance with the lead-free specification, and any solder with the above alloy composition may be used.

Contents

Specifications	2	Alignment	9
Exploded View & Miscellaneous Parts	3	MAIN Unit (Lot. 1~5)	17
Block Diagram	5	MAIN Unit (Lot. 6~)	21
Circuit Description	7	MAIN Unit Parts List	25

Specifications

VTX/EXP version

General

Frequency Range:	450MHz - 512MHz (Version VTX, Type D), 450MHz - 520MHz (Version EXP, Type D), 400MHz - 470MHz (Version VTX/EXP, Type A)
Number of Channels:	16
Power Supply Voltage:	7.4 V DC \pm 10 %
Channel Spacing:	12.5 / 20 / 25 kHz
Battery Life (5-5-90 duty):	9 hrs (7.3 hrs w/o saver) w/FNB-V103LI (1150 mAh) 16.5 hours (13.5 hrs w/o saver) w/FNB-V104LI (2000 mAh)
Operating Temperature Range:	+22 °F to +140 °F (-30 °C to +60 °C)
Frequency Stability:	\pm 2.5 ppm
RF Input-Output Impedance:	50 Ohm
Dimension (W x H x D):	2.3" x 4.3" x 1.2" (58 x 110 x 30 mm)
Weight (Approx.):	10.1 oz (285 g) w/FNB-V103LI, Antenna, Belt Clip

Receiver (measured by TIA/EIA-603)

Sensitivity (12 dB SINAD):	0.25 μ V typical
Adjacent Channel Selectivity:	65 / 60 dB (25 kHz / 12.5 kHz)
Intermodulation:	65 / 60 dB (25 kHz / 12.5 kHz)
Spurious and Image Rejection:	65 dB
Audio Output:	500 mW @ 4 ohms 5 % THD

Transmitter (measured by TIA/EIA-603)

Output Power:	5 / 1 W
Modulation:	16K0F3E, 11K0F3E
Conducted Spurious Emission:	65 dB below carrier
FM Hum & Noise:	45 / 40 dB (25 kHz/ 12.5 kHz)
Audio Distortion:	< 3 % @1 kHz

EU version

General

Frequency Range:	400MHz - 470MHz (VX-231-EG6B-5)
Number of Channels:	16
Power Supply Voltage:	7.4 V DC \pm 10 %
Channel Spacing:	12.5 / 20 / 25 kHz
Battery Life (5-5-90 duty):	9 hrs (7.3 hrs w/o saver) w/FNB-V103LI (1150 mAh) 16.5 hours (13.5 hrs w/o saver) w/FNB-V104LI (2000 mAh)
Temperature Range:	-20 °C to +55 °C (Operation) -0 °C to +45 °C (Battery Charging) Turn the radio off while charging the battery, and use only the Vertex Standard Co., Ltd. Model PA-42C/U AC Adapter and CD-34 Desktop.
Frequency Stability:	\pm 2.5 ppm
RF Input-Output Impedance:	50 Ohm
Battery Pack:	FNB-V103LI / FNB-V104LI Risk of explosion if battery is replaced by an incorrect type. Dispose of used batteries according to the instructions.
Dimension (W x H x D):	58 x 110 x 30 mm
Weight (Approx.):	285 g w/FNB-V103LI, Antenna, Belt Clip

Receiver (Measurement per EN 300 086)

Sensitivity (20 dB SINAD):	0.5 μ V
Adjacent Channel Selectivity:	70 / 60 dB (25 kHz / 12.5 kHz)
Intermodulation:	65 dB
Spurious and Image Rejection:	70 dB
FM Noise:	45 / 40 dB (25 kHz / 12.5 kHz)
Spurious Emission:	-36 dBm (<1GHz), -30 dBm (>1GHz)
Audio Output:	500 mW @ 4 ohms 5 % THD

Transmitter (Measurement per EN 300 08)

Output Power:	5 / 1 W
Modulation:	Variable Reactance Modulation
Maximum Frequency Deviation:	\pm 2.5 / \pm 4.0 / \pm 5.0 kHz (12.5 kHz / 20 kHz / 25 kHz)
FM Hum & Noise:	45 / 40 dB (25 kHz / 12.5 kHz)
Audio Distortion:	< 5 % @1 kHz
Spurious Emission:	-36 dBm (<1GHz), -30 dBm (>1GHz)

Specification may be changed without notification.

Exploded View & Miscellaneous Parts

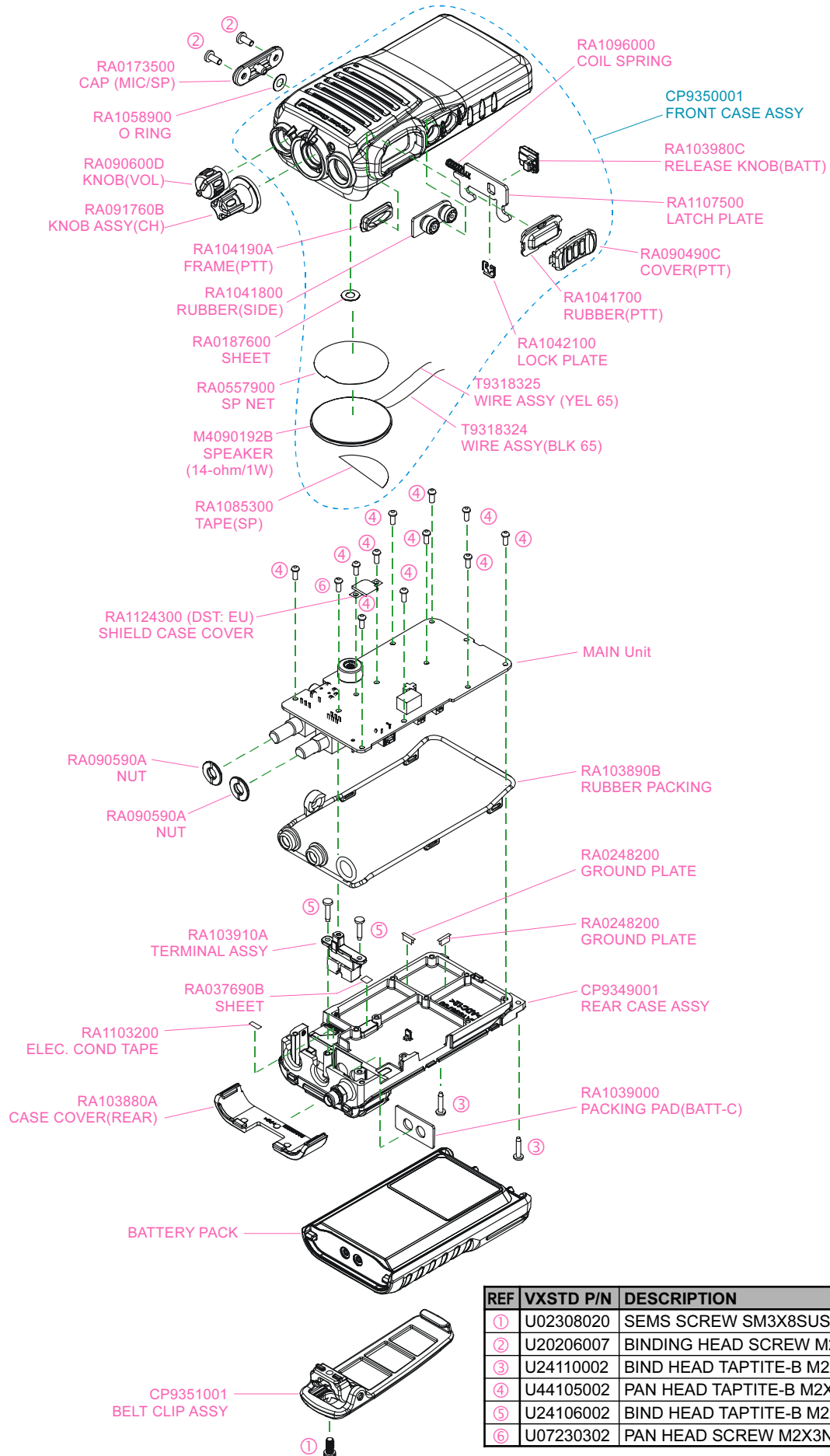

REF	VXSTD P/N	DESCRIPTION	QTY.
①	U02308020	SEMS SCREW SM3X8SUS	1
②	U20206007	BINDING HEAD SCREW M2.6X6B	2
③	U24110002	BIND HEAD TAPTITE-B M2X10NI	2
④	U44105002	PAN HEAD TAPTITE-B M2X5NI	11
⑤	U24106002	BIND HEAD TAPTITE-B M2X6NI	2
⑥	U07230302	PAN HEAD SCREW M2X3NI #3	1

Non-designated parts are available only as part of a designated assembly.

Note

Block Diagram

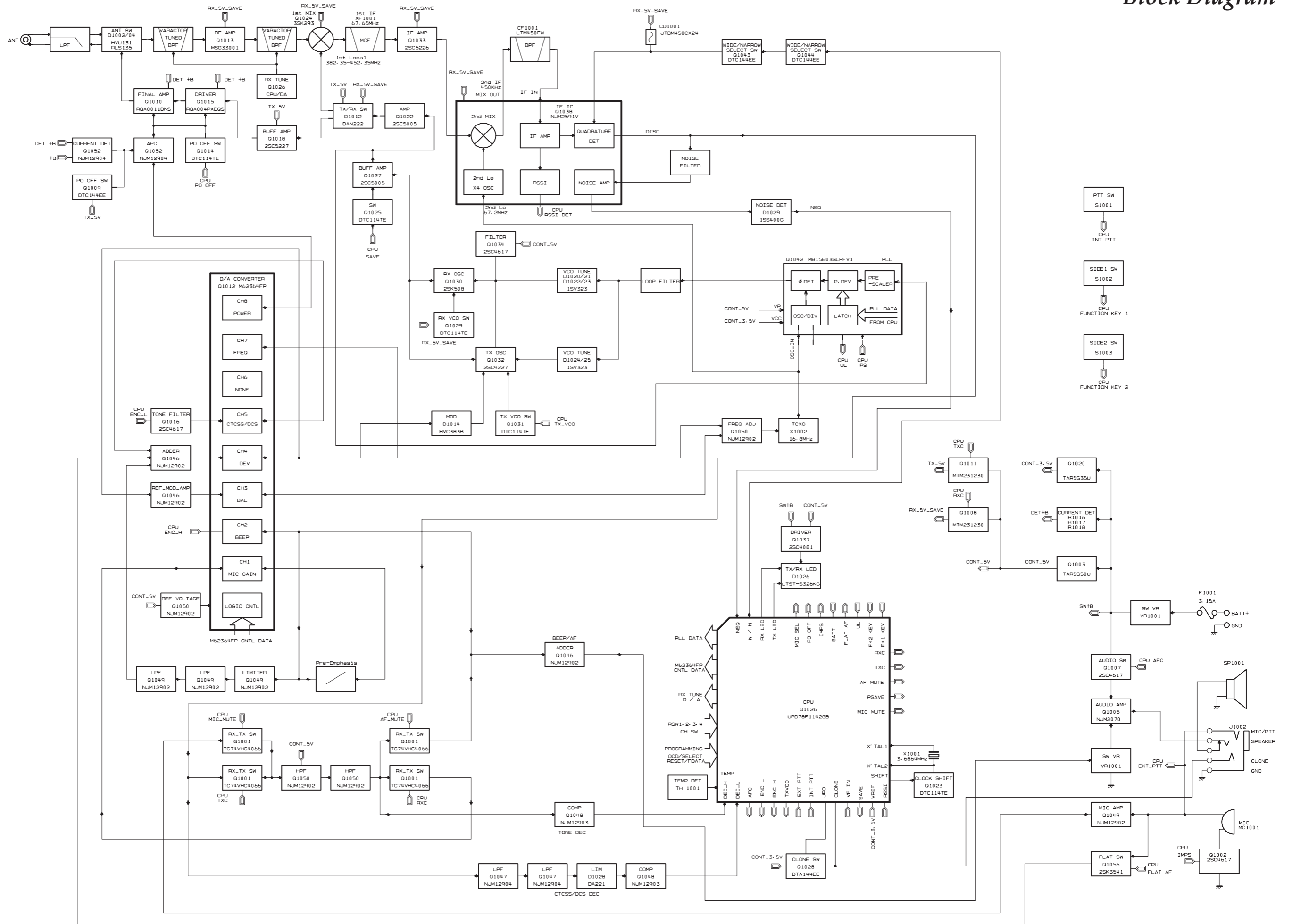

Block Diagram

Note

1. Circuit Configuration by Frequency

The receiver is a Double-conversion Super-heterodyne with a first intermediate frequency (IF) of 67.65MHz and a second IF of 450kHz. Incoming signal from the antenna is mixed with the local signal from the VCO/PLL to produce the first IF of 67.65MHz.

This is then mixed with the 67.2MHz second local oscillator output to produce the 450kHz second IF. This is detected to give the demodulated signal.

The transmit signal frequency is generated by the PLL VCO, and modulated by the signal from the microphone. It is then amplified and sent to the antenna

2. Receiver System

2-1. Front-end RF amplifier

Incoming RF signal from the antenna is delivered to the RF Unit and passes through Low-pass filter, antenna switching diode, high pass filter and removed undesired frequencies by varactor diode (tuned band-pass filter).

The passed signal is amplified in **Q1013 (MSG33001)** and moreover cuts an image frequency with the tuned band pass filter and comes into the 1st mixer.

2-2. First Mixer

The 1st mixer consists of the **Q1024 (3SK293)**. Buffered output from the VCO is amplified by **Q1027 (2SC5005)** to provide a pure first local signal between 382.35 and 444.35 MHz (EXP: 452.35 MHz) for injection to the first mixer.

The IF signal then passes through monolithic crystal filters **XF1001** (± 7.5 kHz BW) to strip away all but the desired signal.

2-3. IF Amplifier

The first IF signal is amplified by **Q1033 (2SC5226)**.

The amplified first IF signal is applied to FM IF subsystem IC **Q1038 (NJM2591V)** which contains the second mixer, second local oscillator, limiter amplifier, noise amplifier, and RSSI amplifier.

The signal from reference oscillator **X1002** becomes 4 times of frequencies in **Q1038**, it is mixed with the IF signal and becomes 450kHz.

The second IF then passes through the ceramic filter **CF1001 (LTM450FW)** to strip away unwanted mixer products, and is applied to the limiter amplifier in **Q1038**, which removes amplitude variations in the 450kHz IF, before detection of the speech by the ceramic discriminator **CD1001 (JTBM450CX24)**.

2-4. Audio amplifier

Detected signal from **Q1038** is inputted to TX/RX switch **Q1001-4 (TC74VHC4066AFT)**.

The signal which appeared from **Q1001** is in high pass filter **Q1050 (NJM12902V)**.

The signal which passed **Q1050** goes to AF volume (VR1001). And then the signal goes to audio amplifier **Q1005 (NJM2070M)**.

The output signal from **Q1005** is in audio speaker.

2-5. Squelch Circuit

There are 16 levels of squelch setting from 0 to 15. The level 0 means open the squelch. The level 1 means the threshold setting level and level 14 means tight squelch. From 2 to 13 is established in the middle of threshold and tight.

The bigger figure is nearer the tight setting. The level 15 becomes setting of carrier squelch.

2-5-1. Noise Squelch

Noise squelch circuit is composed of the band path filter of **Q1038**, and noise detector **D1029 (1SS400G)**.

When a carrier isn't received, the noise ingredient which goes out of the demodulator **Q1038** is amplified in **Q1038** through the band path filter **Q1038**, is detected to DC voltage with **D1029** and is inputted to 52pin (the A/D port) of the **Q1026 (CPU)**.

When a carrier is received, the DC voltage becomes low because the noise is compressed.

When the detected voltage to CPU is high, the CPU stops AF output with Q1001-3 "OFF" by making the 41pin (CPU) "L" level.

When the detection voltage is low, the CPU makes **Q1001** ON with making 41pin "H" and the AF signal is output.

2-5-2. Carrier Squelch

The CPU (53pin: A/D port) detect RSSI voltage output from **Q1038** 12 pin, and controls AF output.

The RSSI output voltage changes according to the signal strength of carrier. The stronger signal makes the RSSI voltage to be higher voltage.

The process of the AF signal control is same as Noise Squelch The shipping data is adjusted -1dB μ (EMF) higher than squelch tight sensitivity.

3. Transmitter System

3-1. Mic Amplifier

The AF signal from internal microphone MC1001 or external microphone J1002 is amplified with microphone amplifier **Q1049-3 (NJM12902V)**.

This signal enters high pass filter **Q1050** via the mute switch **Q1001-1 (TC74VHC4066AFT)**.

Afterwards, the switch circuit is controlled in the gain by way of microphone gain volume **Q1012 (M62364FP-CH1)**.

AF signal is passes a pre-emphasis circuit and is input to the limiter amplifier **Q1049-2 (NJM12902V)**.

The signal passed splatter filter of **Q1049** and adder amplifier **Q1046** is adjusted by maximum deviation adjustment volume **Q1012 (M62364FP-CH4)**.

The AF signal ingredient is amplified **Q1046 (NJM12902V)**. After that, it is made FM modulation to transmit carrier by the modulator **D1014 (HVC383B)** of VCO.

Circuit Description

3-2. Drive and Final amplifier

The modulated signal from the VCO **Q1032 (2SC4227)** is buffered by **Q1027 (2SC5005)**. Then the signal is buffered by **Q1018 (2SC5227)** for the final amplifier driver **Q1015 (RQA0004PXDQS)**. The low-level transmit signal is then applied to **Q1010 (RQA0011DNS)** for final amplification up to 5watts output power.

The transmit signal then passes through the antenna switch **D1002 (HVU131)** and is low pass filtered to suppress away harmonic spurious radiation before delivery to the antenna.

3-3. Automatic Transmit Power Control

The current detector **Q1052-1(NJM12904R)** detects the current of **Q1010** and **Q1015**, and converts the current difference to the voltage difference.

The output from the current detector **Q1052-1** is compared with the reference voltage and amplified by the power control amplifier **Q1052-2**.

The output from **Q1052-2** controls the gate bias of the final amplifiers **Q1010** and the final amplifier driver **Q1015**.

The reference voltage changes into four values (Transmit Power High and Low) controlled by **Q1012 (M62364FP-CH8)**.

3-4. PLL Frequency Synthesizer

The frequency synthesizer consists of PLL IC, **Q1042 (MB15E03SL)**, VCO, TCXO (X1002) and buffer amplifier.

The output frequency from TCXO is 16.8MHz and the tolerance is ± 2.5 ppm (in the temperature range -30 to +60 degrees).

3-4-1. VCO

While the radio is receiving, the RX oscillator **Q1030 (2SK508)** in VCO generates a programmed frequency between 382.35 and 444.35 MHz (EXP: 452.35 MHz) as 1st local signal.

While the radio is transmitting, the TX oscillator **Q1032 (2SC4227)** in VCO generates a frequency between 450 and 512 MHz (EXP: 520 MHz).

The output from oscillator is amplified by buffer amplifier **Q1027 (2SC5005)** and becomes output of VCO. The output from VCO is divided, one is amplified by **Q1027** and feed back to the PLL IC 8pin. It is put into the mixer as the 1st local signal through **D1012**, in transmission, it is buffered **Q1018**, and more amplified in **Q1015** through **D1012** and it is put into the final amplifier **Q1010**.

3-4-2. VCO Tuning Voltage

Tuning voltage of VCO is expanding the lock range of VCO by controlling the cathode of varactor diode at the voltage and the control voltage from PLL IC.

3-4-3. PLL

The PLL IC consists of reference divider, main divider, phase detector, charge pumps and pulse swallow operation. The reference frequency from TCXO is inputted to 1pin of PLL IC and is divided by reference divider.

The other hand, inputted feed back signal to 8pin of PLL IC from VCO is divided with the dividing ratio which becomes same frequency as the output of reference divider. These two signals are compared by phase detector, the phase difference pulse is generated.

The phase difference pulse and the pulse from through the charge pumps and LPF. It becomes the DC voltage to control the VCO. The oscillation frequency of VCO is locked by the control of this DC voltage.

The PLL serial data from CPU is sent with three lines of SDO (60pin), SCK (58pin) and PSTB (59pin).

The lock condition of PLL is output from the UL (14Pin) terminal and UL becomes "H" at the time of the lock condition and becomes "L" at the time of the unlocked condition. The CPU always watches over the UL condition, and when it becomes "L" unlocked condition, the CPU prohibits transmitting and receiving.

Introduction

The **VX-230** series has been aligned at the factory for the specified performance across the entire frequency range specified. Realignment should therefore not be necessary except in the event of a component failure. All component replacement and service should be performed only by an authorized Vertex Standard representative, or the warranty policy may be voided.

The following procedures cover the sometimes critical and tedious adjustments that are not normally required once the transceiver has left the factory. However, if damage occurs and some parts are replaced, realignment may be required. If a sudden problem occurs during normal operation, it is likely due to component failure; realignment should not be done until after the faulty component has been replaced.

We recommend that servicing be performed only by authorized Vertex Standard service technicians who are experienced with the circuitry and fully equipped for repair and alignment. Therefore, if a fault is suspected, contact the dealer from whom the transceiver was purchased for instructions regarding repair. Authorized Vertex Standard service technicians realign all circuits and make complete performance checks to ensure compliance with factory specifications after replacing any faulty components. Those who do undertake any of the following alignments are cautioned to proceed at their own risk. Problems caused by unauthorized attempts at realignment are not covered by the warranty policy. Also, Vertex Standard must reserve the right to change circuits and alignment procedures in the interest of improved performance, without notifying owners. Under no circumstances should any alignment be attempted unless the normal function and operation of the transceiver are clearly understood, the cause of the malfunction has been clearly pinpointed and any faulty components replaced, and the need for realignment determined to be absolutely necessary. The following test equipment (and thorough familiarity with its correct use) is necessary for complete realignment. Correction of problems caused by misalignment resulting from use of improper test equipment is not covered under the warranty policy. While most steps do not require all of the equipment listed, the interactions of some adjustments may require that more complex adjustments be performed afterwards. Do not attempt to perform only a single step unless it is clearly isolated electrically from all other steps. Have all test equipment ready before beginning, and follow all of the steps in a section in the order presented.

Required Test Equipment

- Radio Tester with calibrated output level at 500 MHz
- In-line Wattmeter with 5% accuracy at 500 MHz
- 50-ohm, 10-W RF Dummy Load
- Regulated DC Power Supply (standard 7.5 VDC, 2 A)
- Frequency Counter: ± 0.2 ppm accuracy at 500 MHz
- AF Signal Generator
- AC Voltmeter
- DC Voltmeter
- UHF Sampling Coupler
- Microsoft® Windows® 2000, XP, or Vista
- Microsoft® Net Framework 2.0 or later
- Vertex Standard CE99 Alignment program and CT-42 Connection Cable or FIF-10A USB Programming Interface and CT-106 PC Programming Cable.

Alignment Preparation & Precautions

A 50-ohm RF Dummy load and in-line wattmeter must be connected to the main antenna jack in all procedures that call for transmission, except where specified otherwise. Correct alignment is not possible with an antenna.

After completing one step, read the following step to determine whether the same test equipment will be required. If not, remove the test equipment (except dummy load and wattmeter, if connected) before proceeding.

Correct alignment requires that the ambient temperature be the same as that of the transceiver and test equipment, and that this temperature be held constant between 20 °C and 30 °C (68 °F ~ 86 °F). When the transceiver is brought into the shop from hot or cold air, it should be allowed time to come to room temperature before alignment.

Whenever possible, alignments should be made with oscillator shields and circuit boards firmly affixed in place. Also, the test equipment must be thoroughly warmed up before beginning.

Note: Signal levels in dB referred to in this procedure are based on 0 dB μ EMF = 1.0 μ V.

Alignment

Test Setup

Setup the test equipment as shown for transceiver alignment, then apply 7.5 V DC power to the transceiver.

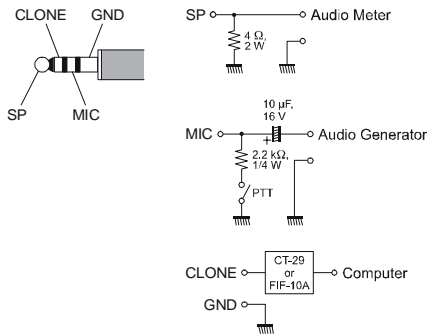
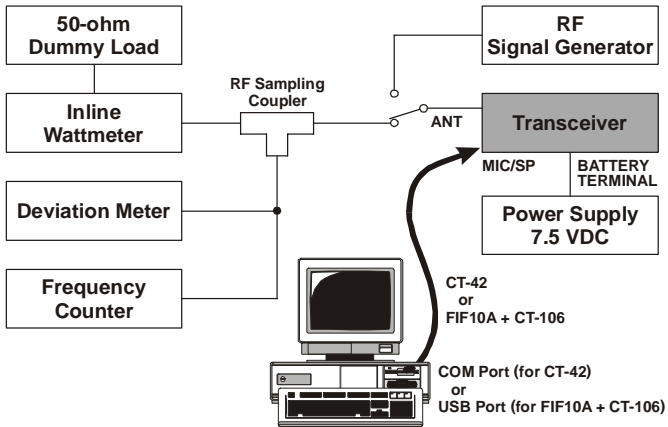

The Alignment Tool Outline

Installation the tool

- Install the CE99 (Clone Editor) to your PC.
- “Basic Alingment” function in the “Radio” menu of CE99.

Action of the switches

When the transceiver is in alignment mode, the action of PTT and KEY is ignored. All of the action is remote controlled by PC.

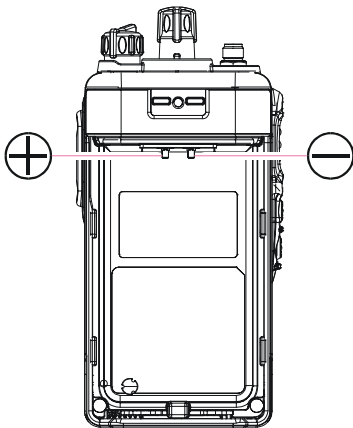

Caution!

Please never turn off a power supply while alignment. If the power supply turn off while alignment, the setting data is failed.

Basic Alignment Mode

In the Basic Alignment mode, the aligned data written in the radio will be able to re-align its alignment data. In this mode, there are many items to align with five points (F1, F2, F3, F4, F5) except “Frequency”, “Mic Sense”, “SQL/RSSI”, and “Battery”. The value of each parameter can be changed to desired position by “←” / “→” arrow key for up/down, direct number input and drag the mouse.

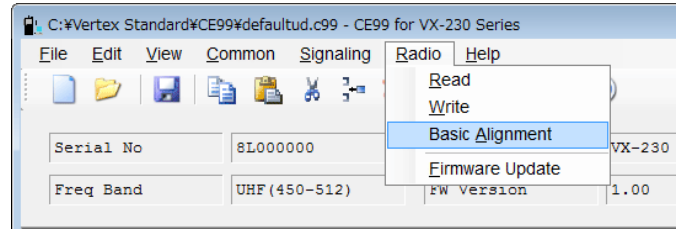

To enter the Basic Alignment Mode, select “Basic Alignment” in the main menu “Radio”. It will start to “Read” the written personalized data from the radio. Then pressing the button “OK” will start the Basic Alignment Mode.

Note: when all items are aligned, it is strongly recommended to align according to following order. The detail information is written in the help of CE99 (Clone Editor).

1. PLL Reference Frequency (Frequency)
2. RX Sensitivity (RX Tune)
3. Squelch (SQL/RSSI)
4. TX Power <High> / <Low>
5. Mic Sense
6. Maximum Deviation <Wide> / <Narrow>
7. Modulation Balance <Wide> / <Narrow>
8. CTCSS Deviation <Wide> / <Narrow>
9. DCS Deviation <Wide> / <Narrow>
10. Battery

Unit

During alignment, you may select the value among dBμV, μV (EMF or PD), or dBm.

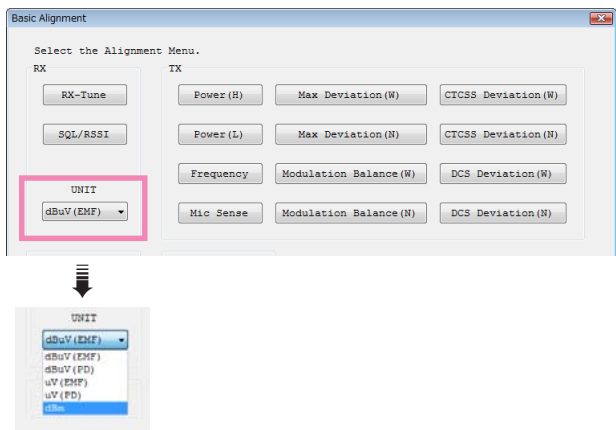

When perform the RX Tune and SQL alignment, the RF level shows this unit according to this setting.

1. PLL REFERENCE FREQUENCY (FREQUENCY)

This parameter is to align the reference frequency for PLL.

1. Press the “Frequency” button to start the alignment. It will appear the Frequency Alignment window.
2. Click the “PTT” button, then the radio starts to transmit on center frequency channel.
3. Set the value to get desired frequency by drag the slide bar, click the up-down button, press the left or right key, or enter the value on the entry box.
4. After getting the desired frequency then click the “PTT” button to stop the transmit.
5. Click the “OK” button to finish the frequency alignment and save the data.

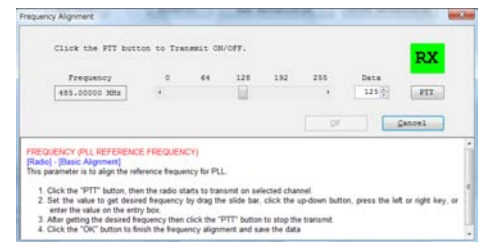
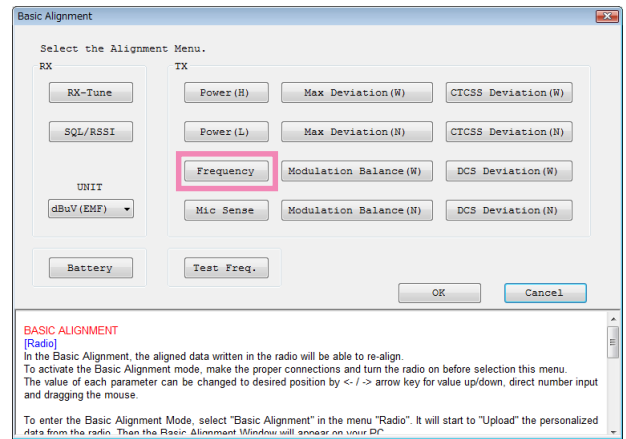

2. RX SENSITIVITY (RX TUNE)

This parameter is to align the RX BPF (Band Pass Filter) for Receive (RX) sensitivity. It must be done both alignments of the “Frequency” before this alignment is going to start. There are following 2 Way for Alignment.

Manual Alignment

1. Press the “RX Tune” button to start the alignment. It will appear the Frequency Alignment window.
2. Click the left mouse button on the slide bar, then switched to selected channel.
3. Set the Signal Generator according to the indication.
4. Drag the slide bar, click the up-down button, press the left or right key, or enter the value on the entry box to get the best RX sensitivity.
5. Click the “OK” button to finish the RX Sensitivity alignment and save the data.

ADJ Type

Single : Alignment value change only to selected channel.

All Freq : Alignment value change for connecting with other channels.

Automatic Alignment

1. Press the “RX Tune” button to start the alignment. It will appear the Frequency Alignment window.
2. Click the left button on the “Auto” button, then the alignment window will appear.
3. Set the Signal Generator according to the indication.
4. Click the left button on the “Start” button, then start the automatic alignment to get the best RX sensitivity.
5. It will show the alignment result in the “New” box.
6. Click the “OK” button to finish the RX Sensitivity alignment and save the data.

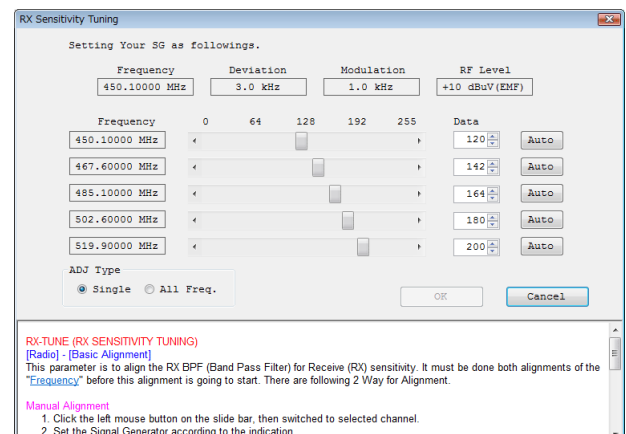
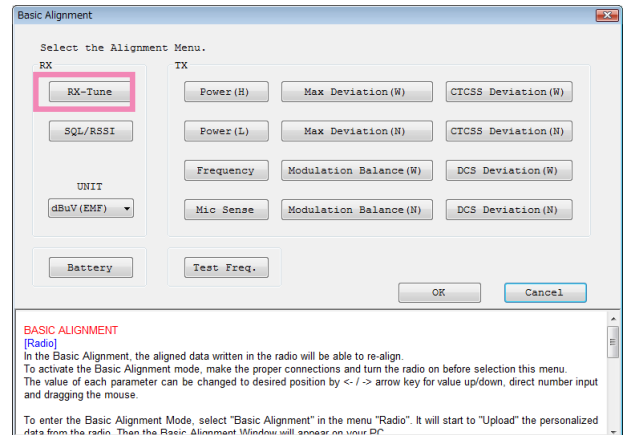

Alignment

3. SQUELCH (SQL)

This parameter is to align the SQL (Squelch) Sensitivity.

There are several alignments as follows in the Squelch Sensitivity.

Threshold SQL Level

The Alignment for the Noise SQL Threshold level at Wide (5k/4k). or Narrow (2.5k).

Tight SQL Level

The Alignment for the Noise SQL Tight level at Wide (5k/4k). or Narrow (2.5k).

Tight SQL RSSI Level

The Alignment for the “level 14” of the RSSI SQL level at Wide (5k/4k). or Narrow (2.5k).

TX Save RSSI Level

The Alignment for the TX Save RSSI level at Wide (5k/4k). or Narrow (2.5k).

The procedure for all the alignment is as follows.

1. Click the “Start” button to open the alignment window in the SQL/RSSI Alignment menu.
2. It will appear the Alignment windows, Set the Signal Generator according to the indication, then click the “Start” button.
3. Then start the automatic alignment to get the SQL or RSSI level.
4. It will show the alignment result in the “New” box.
5. Click the “OK” button, then the data will be saved and the alignment is accomplished.

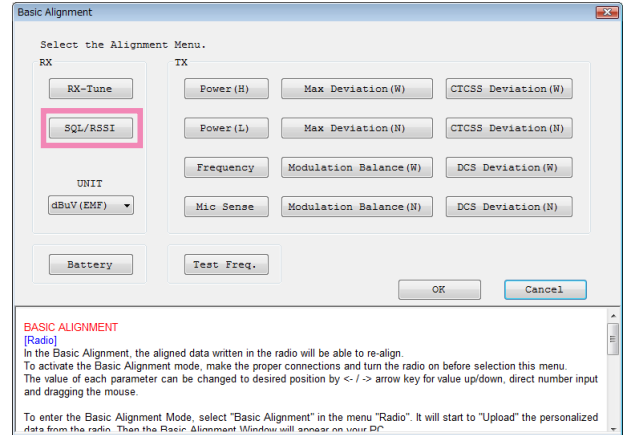

4. TX POWER

This parameter is to align the “Power High” or “Power Low” for the selected channel.

1. Click the “PTT” button at desired channel, then the radio starts to transmit on selected channel.
2. Set the value to get desired output power (High: 5W, Low: 1W) on the Power Meter by drag the slide bar, click the up-down button, press the left or right key, or enter the value on the entry box.
3. After getting the desired output power then click the “PTT” button to stop the transmit.
4. Click the “OK” button to finish the Power high / low alignment and save the data.

ADJ Type

Single : Alignment value change only to selected channel.

All Freq : Alignment value change for connecting with other channels.

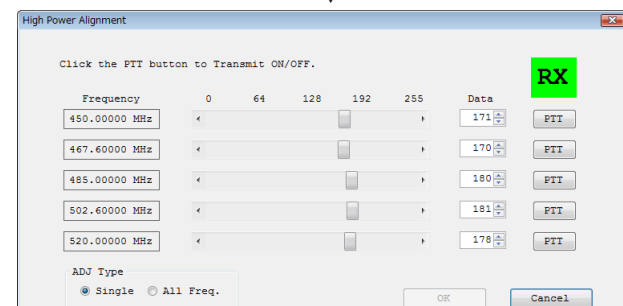
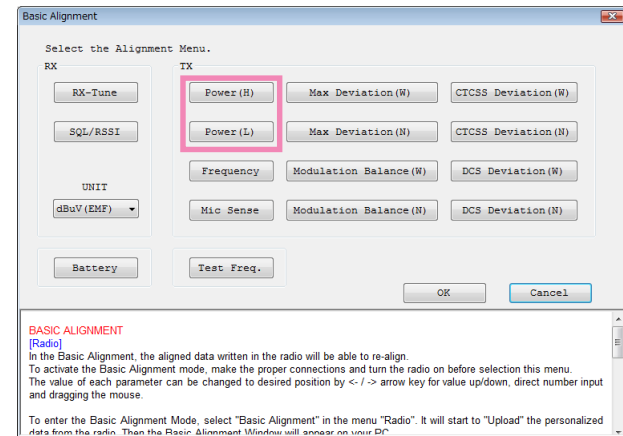

5. MIC SENSE

This parameter is to align the “Microphone Sense” (Gain) and it needs the appropriate JIG (Tuning Interface BOX). Connect the JIG and Test Equipment to the radio before the alignment is going to start. It must be done alignment of the “Max Deviation” before this alignment is going to start.

1. Click the “PTT” button, then the radio starts to transmit on center frequency channel.
2. Inject a 1 kHz tone at 10 mV to the MIC jack.
3. Set the value to get desired Microphone Sense on the deviation meter by drag the slide bar, click the up-down button, press the left or right key, or enter the value on the entry box.
4. After getting the desired deviation then click “PTT” button to stop the transmit.
5. Click “OK” button to finish the Mic Sense alignment and save the data.

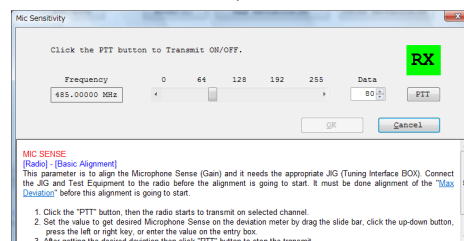
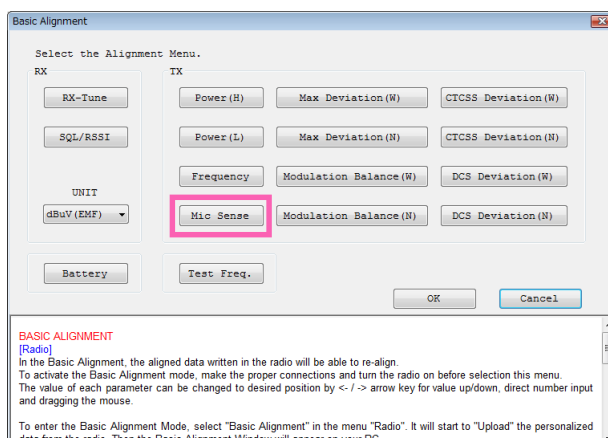

6. MAXIMUM DEVIATION <WIDE> / <NARROW>

This parameter is to align the “Maximum Deviation” (Wide/Narrow) and it needs the appropriate JIG (Tuning Interface BOX). Connect the JIG and Test Equipment to the radio before the alignment is going to start.

1. Click the “PTT” button, then the radio starts to transmit on selected channel.
2. Inject a 1 kHz tone at 100 mV to the MIC jack.
3. Set the value to get desired deviation (Wide: 4.2kHz, Narrow: 2.1kHz) on the deviation meter by drag the slide bar, click the up-down button, press the left or right key, or enter the value on the entry box.
4. After getting the desired deviation then click “PTT” button to stop the transmit.
5. Click “OK” button to finish the Max Deviation alignment and save the data.

ADJ Type

Single : Alignment value change only to selected channel.

All Freq : Alignment value change for connecting with other channels.

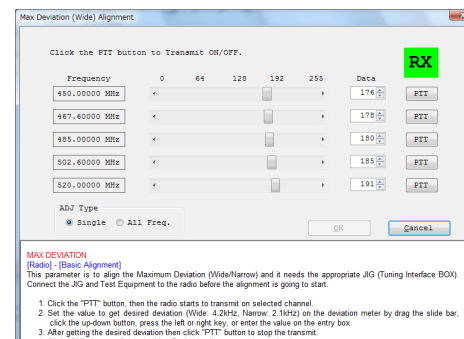
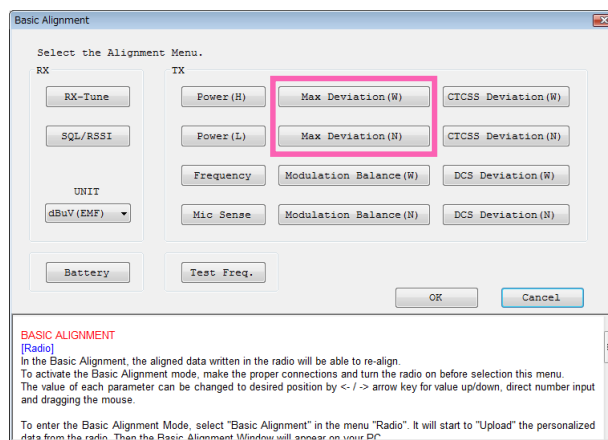

Alignment

7. MODULATION BALANCE <WIDE> / <NARROW> (THIS ALIGNMENT IS DIFFICULT.)

This parameter is to align the “Modulation Deviation” (Wide/Narrow) and it needs the appropriate JIG (Tuning Interface BOX). Connect the JIG and Test Equipment to the radio before the alignment is going to start. It must be done alignment of the "Max Deviation" before this alignment is going to start.

1. Click the “PTT” button, then the radio starts to transmit on selected channel.
2. Set the Audio Generator according to the indication.
3. Set the value to get desired deviation on the deviation meter by drag the slide bar, click the up-down button, press the left or right key, or enter the value on the entry box.
4. After getting the desired deviation then click “PTT” button to stop the transmit.
5. Click the “OK” button to finish the Modulation Balance alignment and save the data.

ADJ Type

Single : Alignment value change only to selected channel.

All Freq : Alignment value change for connecting with other channels.

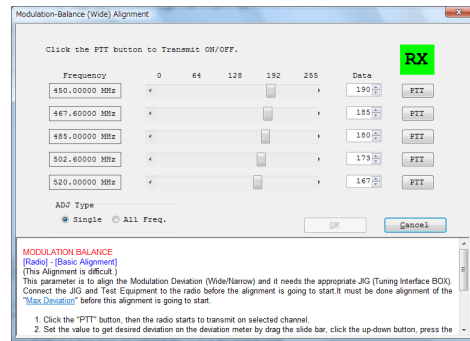
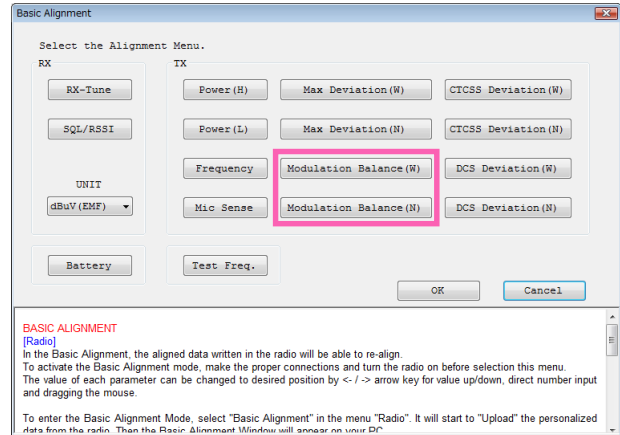

8. CTCSS DEVIATION <WIDE> / <NARROW>

This parameter is to align CTCSS Deviation of the selected channel.

1. Input the desired CTCSS Frequency on the CTCSS Frequency Box.
Default: 151.4Hz,
Input Range: 67.0 to 255.9Hz
2. Click the “PTT” button, then the radio starts to transmit on selected channel.
3. Set the value to get desired deviation on the deviation meter by drag the slide bar, click the up-down button, press the left or right key, or enter the value on the entry box.
4. After getting the desired deviation then click “PTT” button to stop the transmit.
5. Click “OK” button to finish the CTCSS Deviation alignment and save the data.

ADJ Type

Single : Alignment value change only to selected channel.

All Freq : Alignment value change for connecting with other channels.

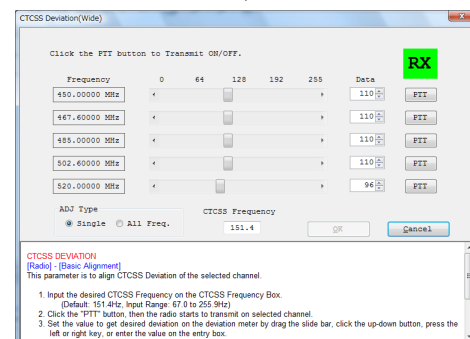
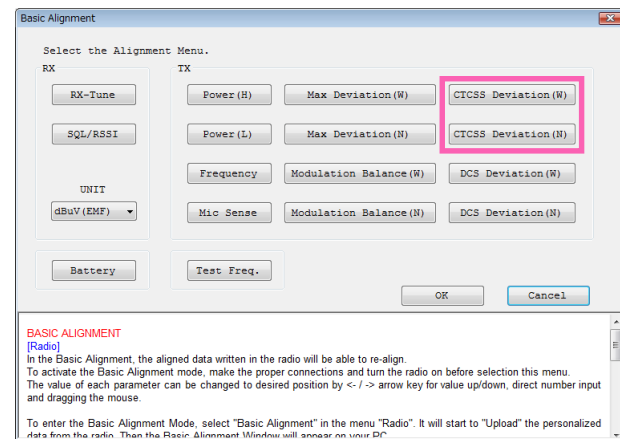

9. DCS DEVIATION <WIDE> / <NARROW>

This parameter is to align “DCS Deviation” of the selected channel.

1. Input the desired DCS Code on the DCS Code Box.
Default: 523
Input Range: 000 to 777
2. Click the “PTT” button, then the radio starts to transmit on selected channel.
3. Set the value to get desired deviation on the deviation meter by drag the slide bar, click the up-down button, press the left or right key, or enter the value on the entry box.
4. After getting the desired deviation then click “PTT” button to stop the transmit.
5. Click “OK” button to finish the DCS Deviation alignment and save the data.

ADJ Type

Single : Alignment value change only to selected channel.

All Freq : Alignment value change for connecting with other channels.

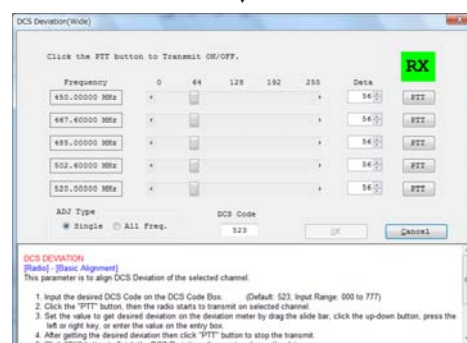
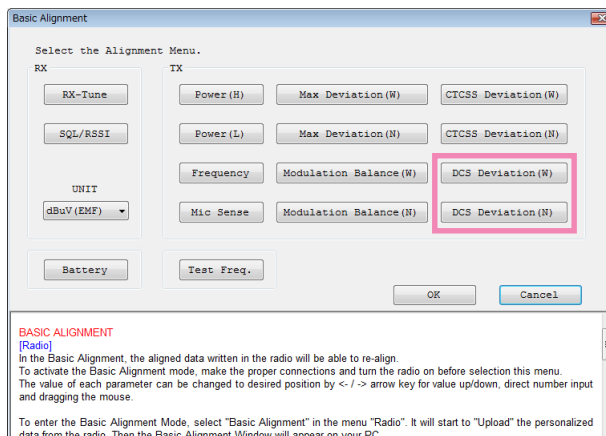

10. BATTERY

This parameter is to align the “Alert Reference voltage” and “Write Protect Level” voltage. When the DC source power becomes below the “Write Protect Level” voltage, the radio will stop writing data to the EEPROM due to prevent the erroneous writing.

1. Set the value of DC Power source to 6.5V (according to the indication) and click “Start” button. Then alignment value show in the “New” box.
2. Set the value of DC Power source to 5.5V (according to the indication) and click “Start” button. Then alignment value show in the "New" box.
3. Click the “OK” button, then the data will be saved and the alignment is accomplished.
4. Set the value of DC Power source to 7.5V (according to the indication).

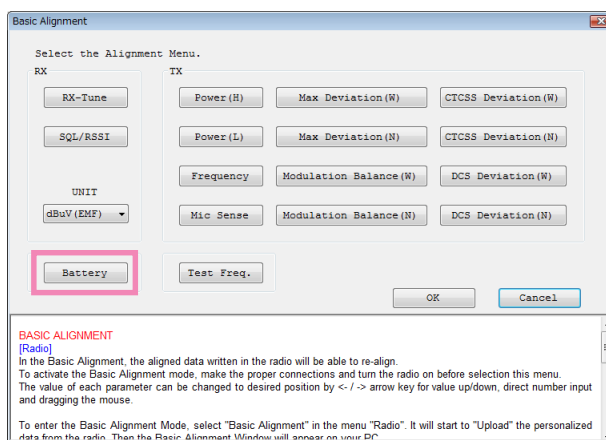

Note

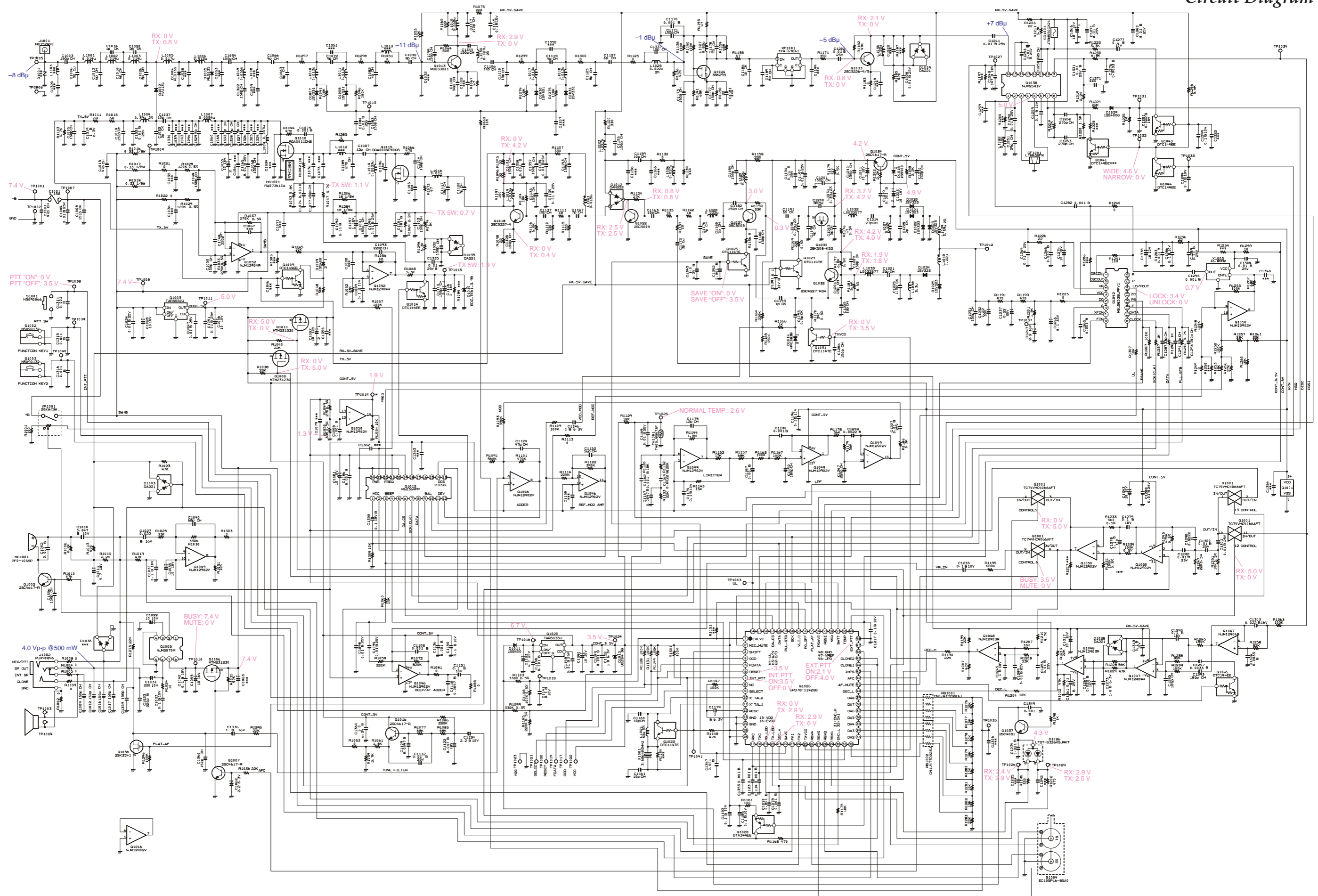

MAIN Unit (Lot. 1~5)

Note

MAIN Unit (Lot. 1~5)

Parts Layout (Side A)

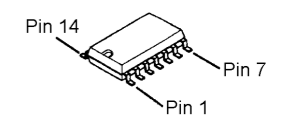
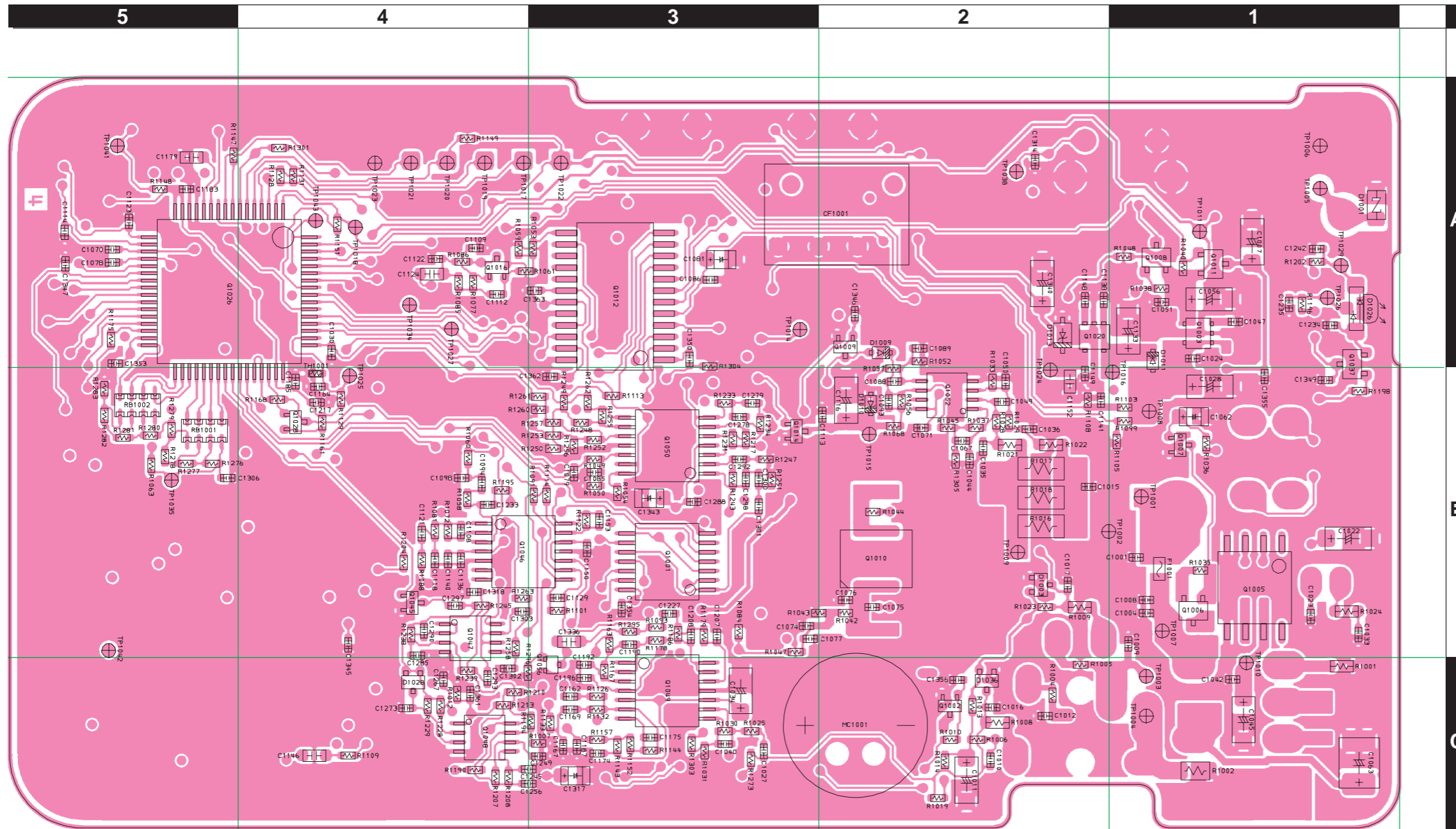

TC74VHC4066AFT (Q1001)
NJM12902V (Q1046, 1049, 1050)

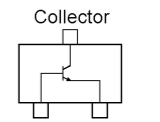

Base Emitter
2SC4617 (Q1002, 1007, 1016)
2SC4081 (Q1037)

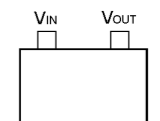

CONTROL GND NOISE
TAR5550U (5V0) (Q1003)
TAR5535U (3V5) (Q1020)

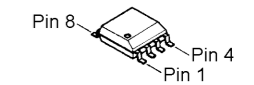

NJM2070M (Q1005)

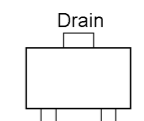

Gate Source
MTM231230L (BL) (Q1006, 1008, 1011)
2SK3541 (Q1056)

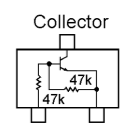

Base Emitter
DTC144EE (26) (Q1009, 1014, 1045)

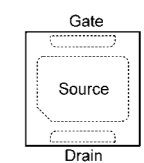

RQA0011DNS (Q1010)

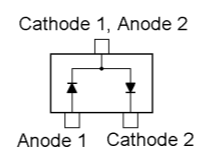

DA221 (K) (D1003, 1028)

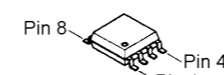

NJM12904R (Q1047, 1052)
NJM12903R-TE1 (Q1048)

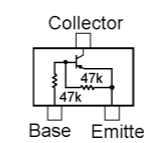

DTA144EE (16) (Q1028)

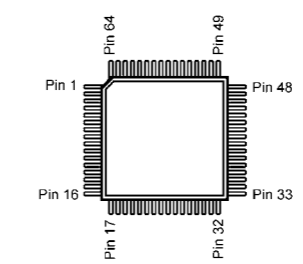

UPD78F1142GB(S)-GAH-AX (Q1026)

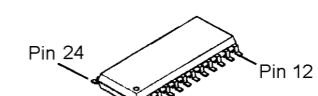

M62364FP (Q1012)

MAIN Unit (Lot. 1~5)

Parts Layout (Side B)

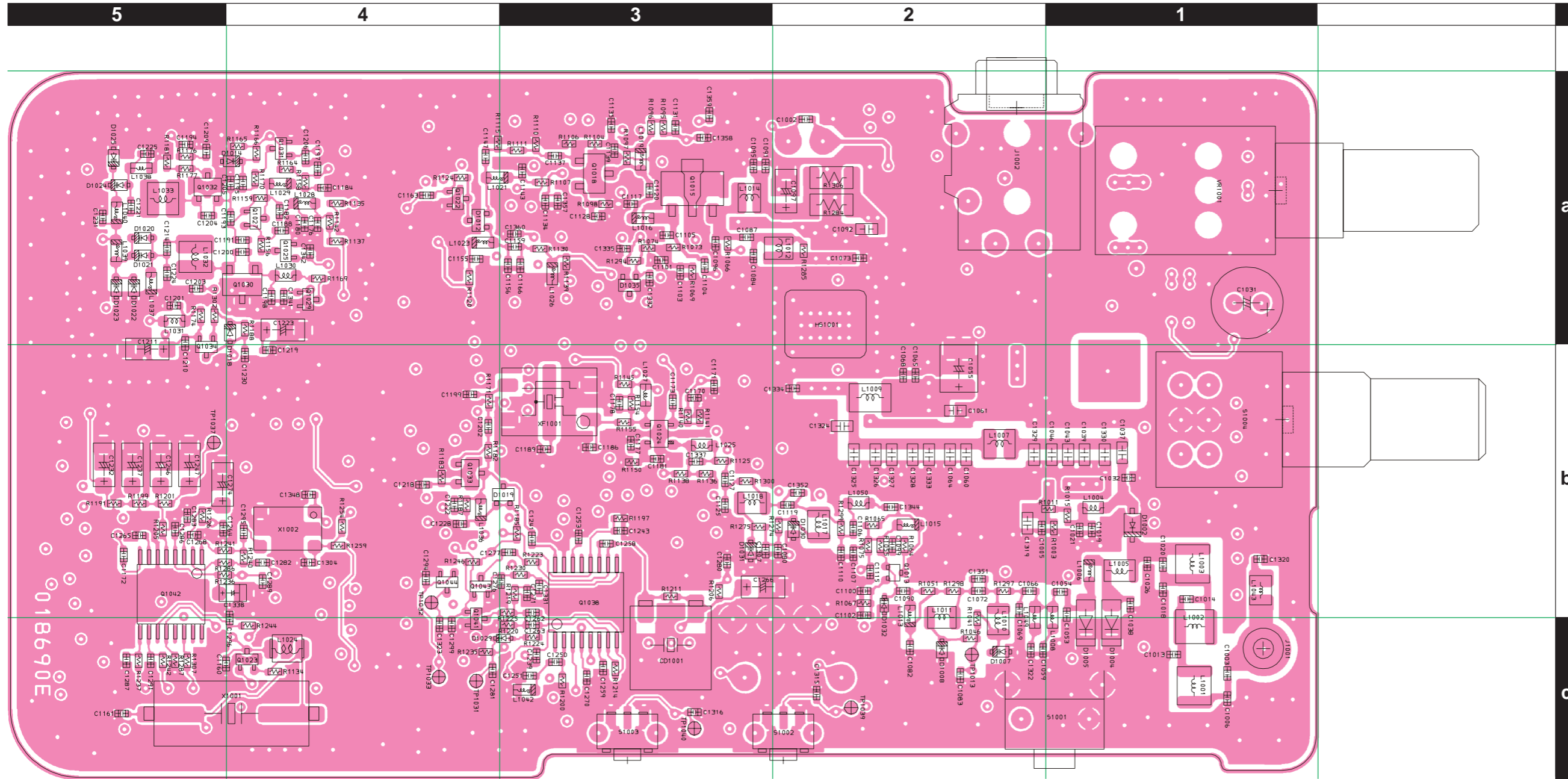

a

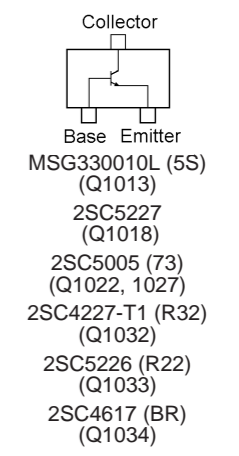

b

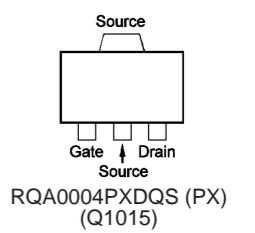

c

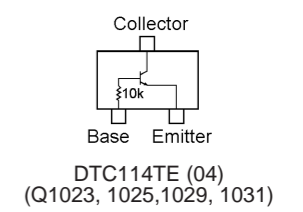
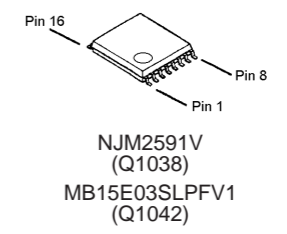
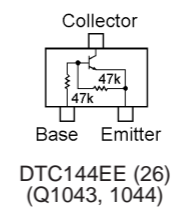
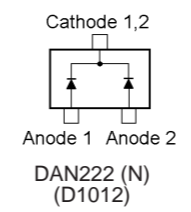
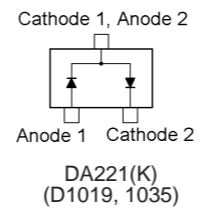
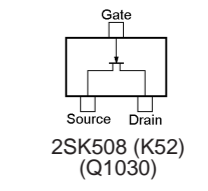
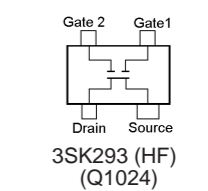

MAIN Unit (Lot. 6~)

Circuit Diagram

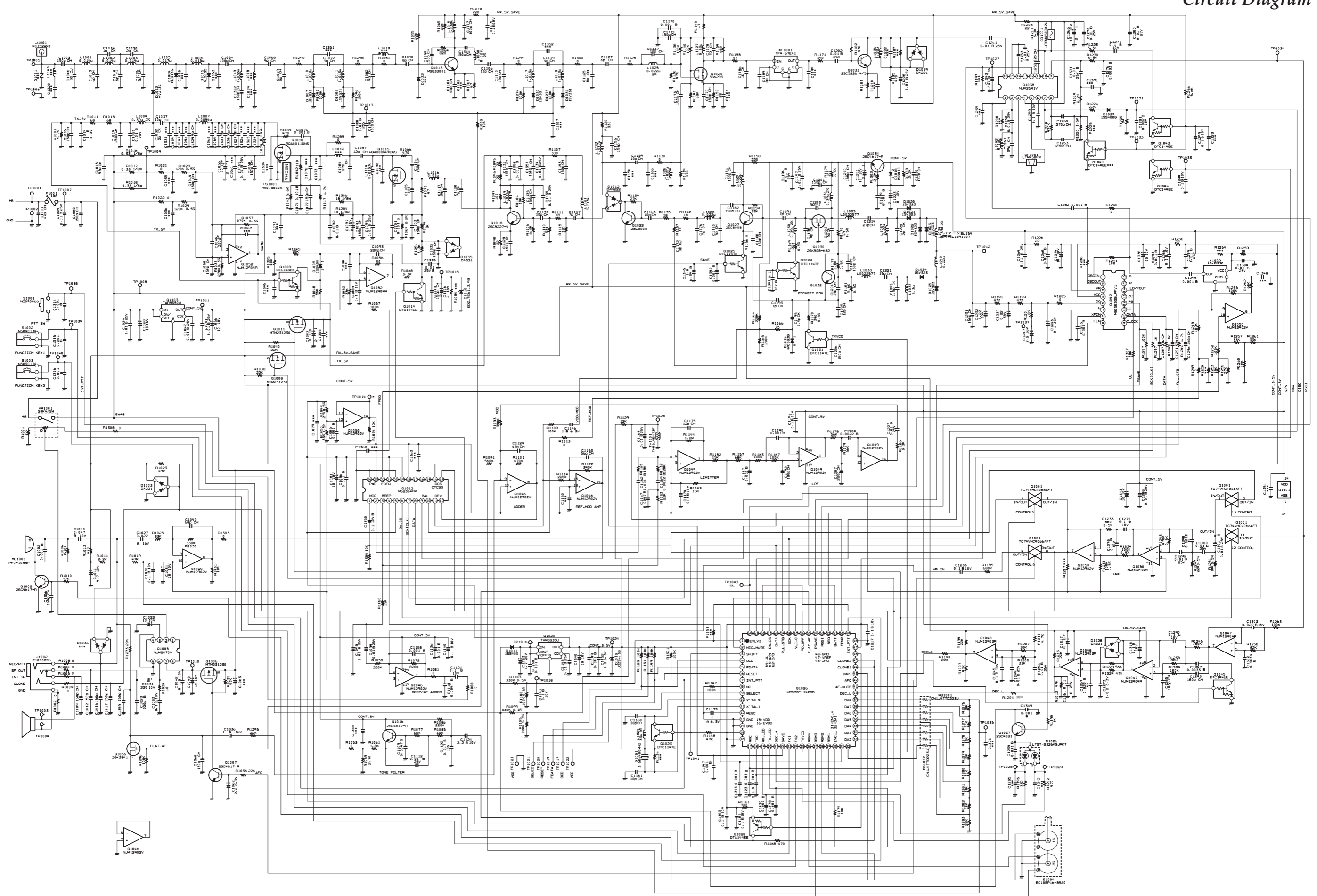

MAIN Unit (Lot. 6~)

Note

MAIN Unit (Lot. 6~)

Parts Layout (Side A)

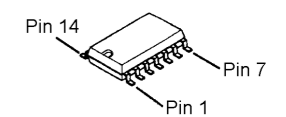
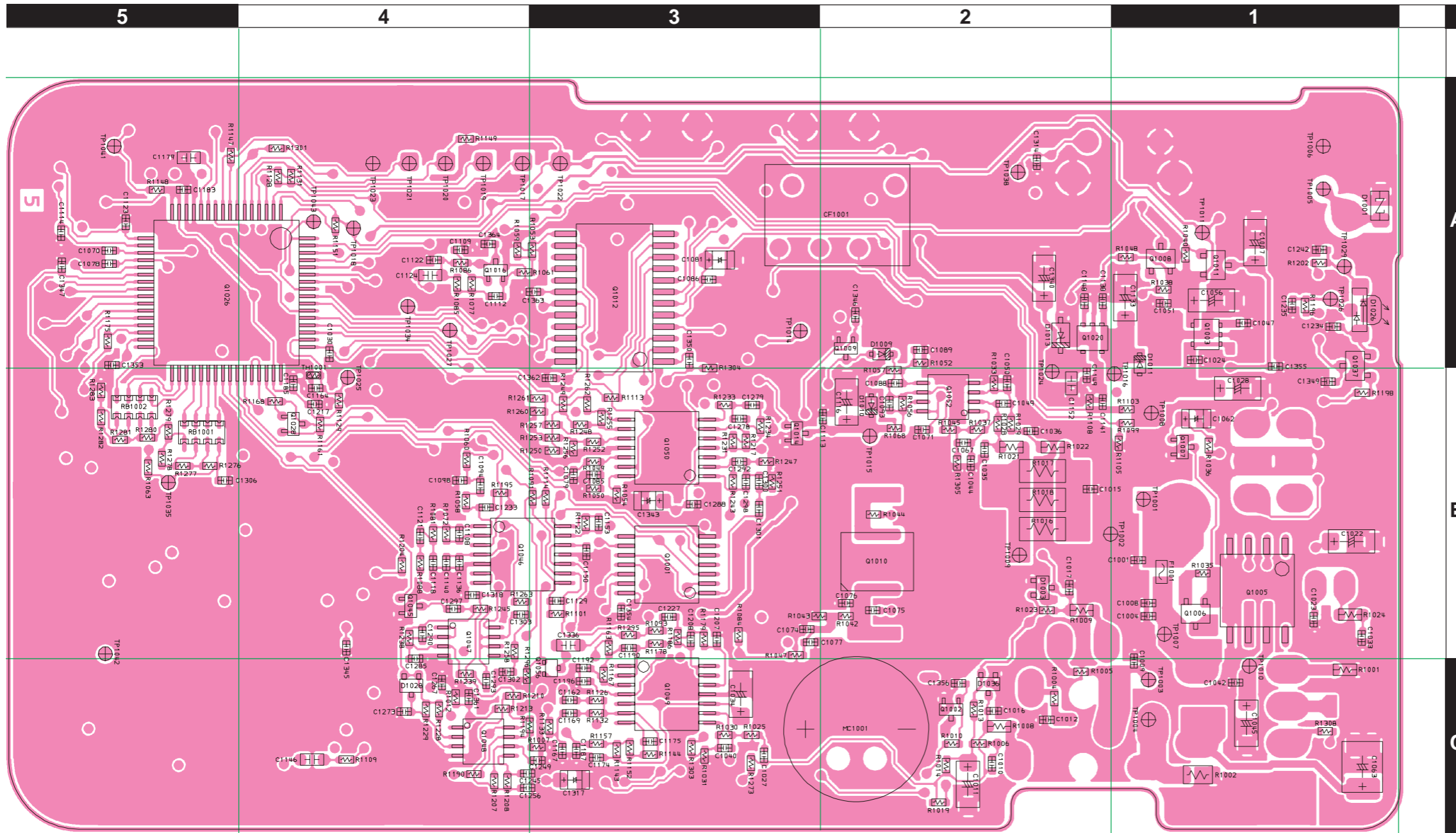

TC74VHC4066AFT (Q1001)
NJM12902V (Q1046, 1049, 1050)

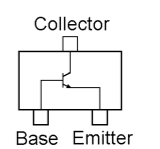

Base Emitter
2SC4617 (Q1002, 1007, 1016)
2SC4081 (Q1037)

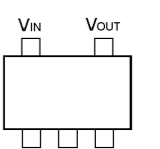

TAR5550U (5V0) (Q1003)
TAR5535U (3V5) (Q1020)

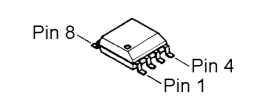

NJM2070M (Q1005)

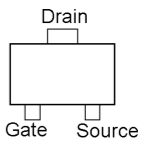

MTM231230L (BL) (Q1006, 1008, 1011)
2SK3541 (Q1056)

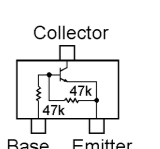

DTC144EE (26) (Q1009, 1014, 1045)

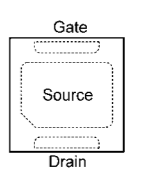

RQA0011DNS (Q1010)

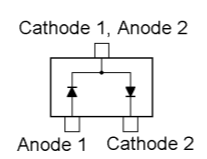

DA221 (K) (D1003, 1028)

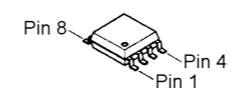

NJM12904R (Q1047, 1052)
NJM12903R-TE1 (Q1048)

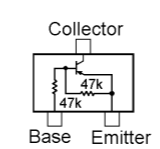

DTA144EE (16) (Q1028)

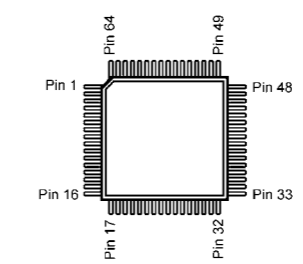

UPD78F1142GB(S)-GAH-AX (Q1026)

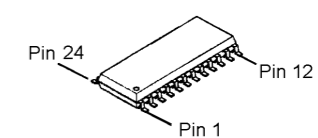

M62364FP (Q1012)

MAIN Unit (Lot. 6~)

Parts Layout (Side B)

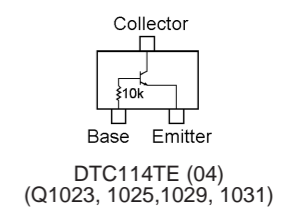
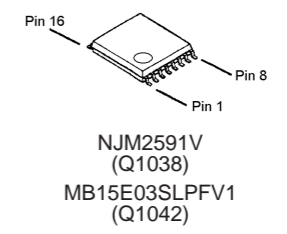
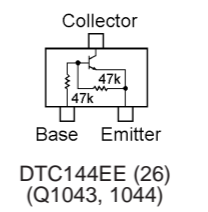
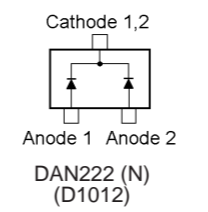
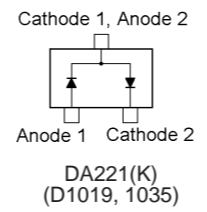
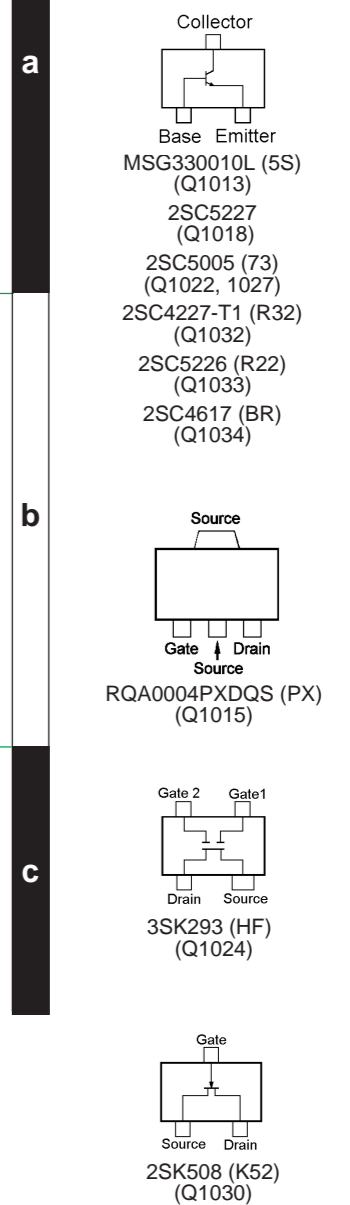
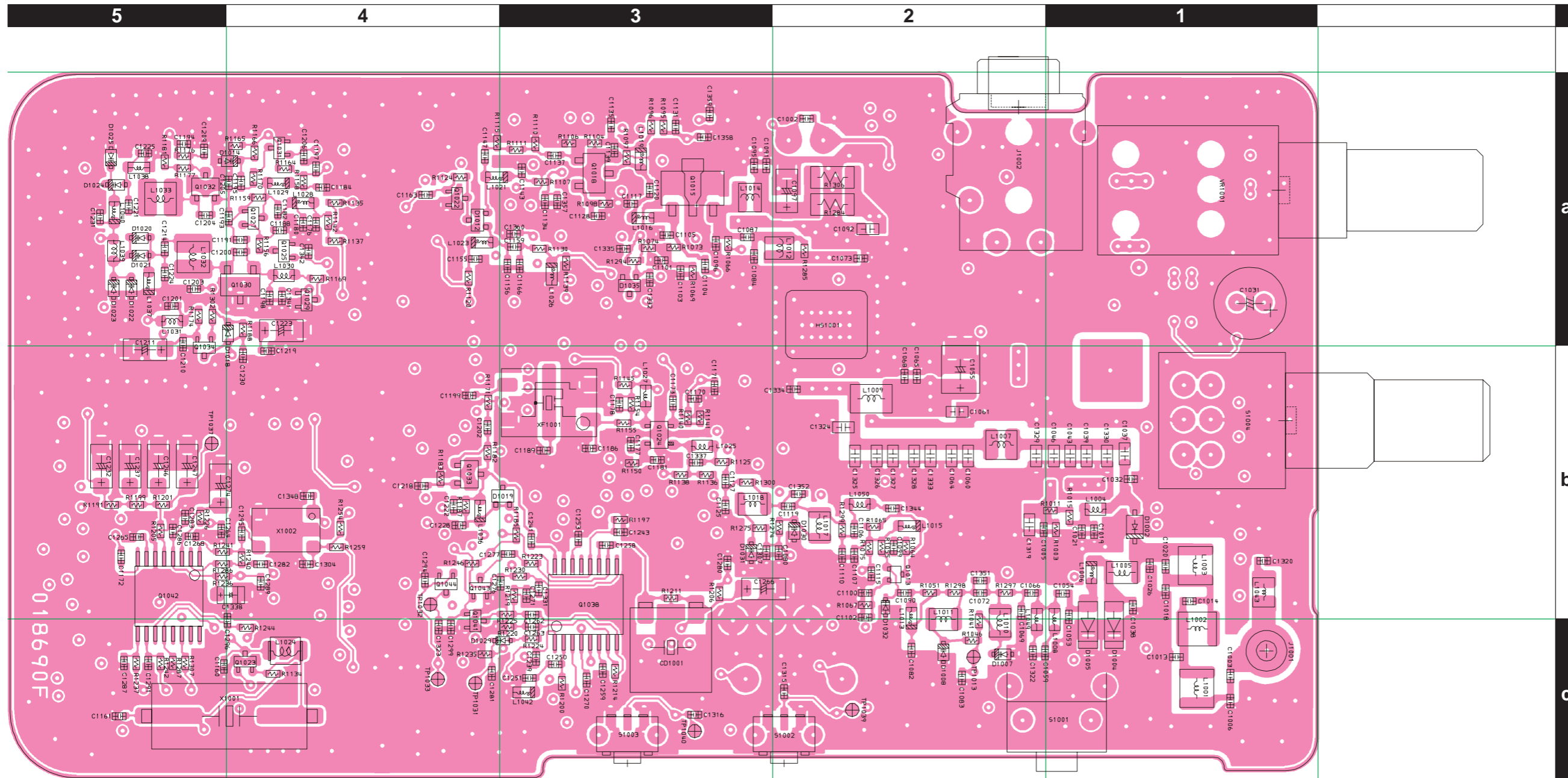

REF.	DESCRIPTION	VALUE	V/W	TOL.	MFR'S DESIG	VXSTD P/N	VERS.	LOT.	SIDE	LAY ADR
PCB with Components						CS2009401	VTX, TYP: D			
						CS2009402	EXP, TYP: D			
						CS2009404	VTX, TYP: A			
						CS2009405	EXP, TYP: A			
						CS2009406	EU			
Printed Circuit Board					AC085U000	FR018690E		1-		
						FR018690F		6-		
C 1001	CHIP CAP.	47pF	50V	CH	GRM1552C1H470JZ01D	K22178228		1-	A	B1
C 1002	CHIP CAP.	0.001uF	50V	B	GRM155B11H102KA01D	K22178809		1-	B	a2
C 1003	CHIP CAP.	150pF	50V	CH	GRM1552C1H151JA01D	K22178240		1-	B	c1
C 1004	CHIP CAP.	0.01uF	25V	B	GRM155B11E103KA01D	K22148834		1-	A	B1
C 1005	CHIP CAP.	150pF	50V	CH	GRM1552C1H151JA01D	K22178240		1-	B	b2
C 1006	CHIP CAP.	3pF	50V	CJ	GRP1553C1H3R0CZ01E	K22178205		1-	B	c1
C 1007	CHIP TA.CAP.	10uF	10V		F931A106MAA	K78100078		1-	A	A1
C 1008	CHIP CAP.	150pF	50V	CH	GRM1552C1H151JA01D	K22178240		1-	A	B1
C 1009	CHIP CAP.	150pF	50V	CH	GRM1552C1H151JA01D	K22178240		1-	A	C1
C 1010	CHIP CAP.	0.047uF	10V	B	GRM155B11A473KA01D	K22108801		1-	A	C2
C 1011	CHIP TA.CAP.	4.7uF	10V		F931A475MAA	K78100077		1-	A	C2
C 1012	CHIP CAP.	150pF	50V	CH	GRM1552C1H151JA01D	K22178240		1-	A	C2
C 1013	CHIP CAP.	6pF	50V	CH	GRM1552C1H6R0DZ01D	K22178208		1-	B	c1
C 1014	CHIP CAP.	1pF	50V	CK	GRM1554C1H1R0BZ01D	K22178287		1-5	B	b1
C 1014	CHIP CAP.	1.5pF	50V	CK	GRM1554C1H1R5BZ01D	K22178288	VERSION A	6-	B	b1
C 1014	CHIP CAP.	1pF	50V	CK	GRM1554C1H1R0BZ01D	K22178287	VERSION D	6-	B	b1
C 1015	CHIP CAP.	47pF	50V	CH	GRM1552C1H470JZ01D	K22178228		1-	A	B2
C 1016	CHIP CAP.	150pF	50V	CH	GRM1552C1H151JA01D	K22178240		1-	A	C2
C 1017	CHIP CAP.	150pF	50V	CH	GRM1552C1H151JA01D	K22178240		1-	A	B2
C 1018	CHIP CAP.	6pF	50V	CH	GRM1552C1H6R0DZ01D	K22178208		1-6	B	b1
C 1018	CHIP CAP.	7pF	50V	CH	GRM1552C1H7R0DZ01D	K22178209	VERSION A	7-	B	b1
C 1018	CHIP CAP.	6pF	50V	CH	GRM1552C1H6R0DZ01D	K22178208	VERSION D	7-	B	b1
C 1019	CHIP CAP.	150pF	50V	CH	GRM1552C1H151JA01D	K22178240		1-	B	b1
C 1020	CHIP CAP.	2pF	50V	CK	GRM1554C1H2R0BZ01D	K22178289		1-5	B	b1
C 1020	CHIP CAP.	2.5pF	50V	CH	CM05CH2R5B50AH	K22178298	VERSION A	6-	B	b1
C 1020	CHIP CAP.	2pF	50V	CK	GRM1554C1H2R0BZ01D	K22178289	VERSION D	6-	B	b1
C 1021	CHIP CAP.	0.01uF	25V	B	GRM155B11E103KA01D	K22148834		1-	B	b1
C 1022	CHIP TA.CAP.	10uF	10V		F931A106MAA	K78100078		1-	A	B1
C 1023	CHIP CAP.	220pF	50V	B	GRM155B11H221KA01D	K22178801		1-	A	B1
C 1024	CHIP CAP.	0.01uF	25V	B	GRM155B11E103KA01D	K22148834		1-	A	A1
C 1026	CHIP CAP.	5pF	50V	CH	GRM1552C1H5R0CZ01D	K22178207		1-	B	b1
C 1027	CHIP CAP.	0.022uF	16V	B	GRM155B11C223KA01D	K22128806		1-	A	C3
C 1028	CHIP TA.CAP.	10uF	16V		F931C106MAA	K78120095		1-5	A	B1
C 1028	CHIP TA.CAP.	4.7uF	16V		F921C475MAA	K78120096		6-	A	B1
C 1030	CHIP CAP.	0.1uF	10V	B	GRM155B11A104KA01D	K22108802		1-	A	A4
C 1031	AL.ELECTRO.CAP.	220uF	10V		ESMG100ELL221ME11S	K40109027		1-	B	a1
C 1032	CHIP CAP.	2pF	50V	CK	GRM1554C1H2R0CZ01D	K22178204		1-	B	b1
C 1033	CHIP CAP.	0.1uF	10V	B	GRM155B11A104KA01D	K22108802		1-	A	B1
C 1034	CHIP TA.CAP.	10uF	10V		F931A106MAA	K78100078		1-	A	C3
C 1037	CHIP CAP.	10pF	50V	CH	GRM1882C1H100JA01D	K22174211		1-5	B	b1
C 1037	CHIP CAP.	15pF	50V	CH	GRM1882C1H150JA01D	K22174215	VERSION A	6	B	b1
C 1037	CHIP CAP.	10pF	50V	CH	GRM1882C1H100JA01D	K22174211	VERSION D	6	B	b1
C 1037	CHIP CAP.	10pF	50V	CH	GRM1882C1H100JA01D	K22174211		7-	B	b1
C 1039	CHIP CAP.	7pF	50V	CH	GRM1882C1H7R0DZ01D	K22174208	VERSION A	7-	B	b1
C 1040	CHIP CAP.	68pF	50V	CH	GRM1552C1H680JZ01D	K22178232		1-	A	C3
C 1042	CHIP CAP.	0.1uF	10V	B	GRM155B11A104KA01D	K22108802		1-	A	C1
C 1044	CHIP CAP.	150pF	50V	CH	GRM1552C1H151JA01D	K22178240		1-	A	B2
C 1045	CHIP TA.CAP.	10uF	16V		F931C106MAA	K78120095		1-	A	C1
C 1047	CHIP CAP.	0.01uF	25V	B	GRM155B11E103KA01D	K22148834		1-	A	A1
C 1049	CHIP CAP.	220pF	50V	CH	GRM1552C1H221JA01D	K22179713		1-	A	B2
C 1050	CHIP CAP.	150pF	50V	CH	GRM1552C1H151JA01D	K22178240		1-	A	B2
C 1051	CHIP CAP.	0.01uF	25V	B	GRM155B11E103KA01D	K22148834		1-	A	A1
C 1054	CHIP CAP.	100pF	50V	CH	GRM1552C1H101JD01D	K22178236		1-	B	b1
C 1055	CHIP TA.CAP.	10uF	16V		F931C106MBA	K78120087		1-	B	b2
C 1056	CHIP TA.CAP.	10uF	10V		F931A106MAA	K78100078		1-	A	A1
C 1062	CHIP TA.CAP.	2.2uF	6.3V		F920J225MPA	K78080101		1-	A	B1
C 1064	CHIP CAP.	9pF	50V	CH	GRM1882C1H9R0DZ01D	K22174210	VERSION A	7-	B	b2
C 1065	CHIP CAP.	0.01uF	25V	B	GRM155B11E103KA01D	K22148834		1-	B	b2
C 1066	CHIP CAP.	4pF	50V	CH	GRM1552C1H4R0CZ01D	K22178206		1	B	b2
C 1066	CHIP CAP.	4pF	50V	CH	GRM1552C1H4R0BZ01D	K22178291		2-5	B	b2

MAIN Unit

Parts List

REF.	DESCRIPTION	VALUE	V/W	TOL.	MFR'S DESIG	VXSTD P/N	VERS.	LOT.	SIDE	LAY ADR
C 1066	CHIP CAP.	8pF	50V	CH	GRM1552C1H8R0BZ01D	K22178295	VERSION A	6	B	b2
C 1066	CHIP CAP.	7pF	50V	CH	GRM1552C1H7R0BZ01D	K22178294	VERSION A	7-	B	b2
C 1066	CHIP CAP.	4pF	50V	CH	GRM1552C1H4R0BZ01D	K22178291	VERSION D	6-	B	b2
C 1068	CHIP CAP.	150pF	50V	CH	GRM1552C1H151JA01D	K22178240		1-	B	b2
C 1069	CHIP CAP.	8pF	50V	CH	GRM1552C1H8R0DZ01D	K22178210		1	B	b2
C 1069	CHIP CAP.	8pF	50V	CH	GRM1552C1H8R0BZ01D	K22178295		2-6	B	b2
C 1069	CHIP CAP.	12pF	50V	CH	GRM1552C1H120JZ01D	K22178214	VERSION A	7-	B	b2
C 1069	CHIP CAP.	8pF	50V	CH	GRM1552C1H8R0BZ01D	K22178295	VERSION D	7-	B	b2
C 1070	CHIP CAP.	0.001uF	50V	B	GRM155B11H102KA01D	K22178809		1-	A	A5
C 1072	CHIP CAP.	4pF	50V	CH	GRM1552C1H4R0CZ01D	K22178206		1	B	b2
C 1072	CHIP CAP.	4pF	50V	CH	GRM1552C1H4R0BZ01D	K22178291		2-6	B	b2
C 1072	CHIP CAP.	3pF	50V	CJ	GRM1553C1H3R0BZ01D	K22178290	EU	7-	B	b2
C 1072	CHIP CAP.	4pF	50V	CH	GRM1552C1H4R0BZ01D	K22178291	VTX/EXP	7-	B	b2
C 1074	CHIP CAP.	0.001uF	50V	B	GRM155B11H102KA01D	K22178809		1-	A	B3
C 1075	CHIP CAP.	0.001uF	50V	B	GRM155B11H102KA01D	K22178809		1-	A	B2
C 1077	CHIP CAP.	150pF	50V	CH	GRM1552C1H151JA01D	K22178240		1-	A	B3
C 1078	CHIP CAP.	0.001uF	50V	B	GRM155B11H102KA01D	K22178809		1-	A	A5
C 1080	CHIP CAP.	0.01uF	25V	B	GRM155B11E103KA01D	K22148834		1-	B	b2
C 1081	CHIP TA.CAP.	10uF	10V		TEESVP1A106M8R	K78100074		1-6	A	A3
C 1081	CHIP TA.CAP.	10uF	10V		F921A106MPA	K78100089		7-	A	A3
C 1082	CHIP CAP.	4pF	50V	CH	GRM1552C1H4R0CZ01D	K22178206		1	B	c2
C 1082	CHIP CAP.	4pF	50V	CH	GRM1552C1H4R0BZ01D	K22178291		2-5	B	c2
C 1082	CHIP CAP.	8pF	50V	CH	GRM1552C1H8R0BZ01D	K22178295	EU	7-	B	c2
C 1082	CHIP CAP.	6pF	50V	CH	GRM1552C1H6R0BZ01D	K22178293	EXP VER. A	7-	B	c2
C 1082	CHIP CAP.	5pF	50V	CH	GRM1552C1H5R0BZ01D	K22178292	VERSION A	6	B	c2
C 1082	CHIP CAP.	4pF	50V	CH	GRM1552C1H4R0BZ01D	K22178291	VERSION D	6-	B	c2
C 1082	CHIP CAP.	6pF	50V	CH	GRM1552C1H6R0BZ01D	K22178293	VTX VER. A	7-	B	c2
C 1083	CHIP CAP.	150pF	50V	CH	GRM1552C1H151JA01D	K22178240		1-	B	c2
C 1084	CHIP CAP.	27pF	50V	CH	GRM1552C1H270JZ01D	K22178222		1-5	B	a3
C 1084	CHIP CAP.	39pF	50V	CH	GRM1552C1H390JZ01D	K22178226	VERSION A	6-	B	a3
C 1084	CHIP CAP.	27pF	50V	CH	GRM1552C1H270JZ01D	K22178222	VERSION D	6-	B	a3
C 1085	CHIP CAP.	0.001uF	50V	B	GRM155B11H102KA01D	K22178809		1-	A	B3
C 1086	CHIP CAP.	0.001uF	50V	B	GRM155B11H102KA01D	K22178809		1-	A	A3
C 1087	CHIP CAP.	12pF	50V	CH	GRM1552C1H120JZ01D	K22178214		1-5	B	a3
C 1087	CHIP CAP.	15pF	50V	CH	GRM1552C1H150JZ01D	K22178216	VERSION A	6-	B	a3
C 1087	CHIP CAP.	12pF	50V	CH	GRM1552C1H120JZ01D	K22178214	VERSION D	6-	B	a3
C 1089	CHIP CAP.	0.1uF	10V	B	GRM155B11A104KA01D	K22108802		1-	A	A2
C 1090	CHIP CAP.	8pF	50V	CH	GRM1552C1H8R0DZ01D	K22178210		1	B	b2
C 1090	CHIP CAP.	8pF	50V	CH	GRM1552C1H8R0BZ01D	K22178295		2-6	B	b2
C 1090	CHIP CAP.	5pF	50V	CH	GRM1552C1H5R0BZ01D	K22178292	VERSION A	7-	B	b2
C 1090	CHIP CAP.	8pF	50V	CH	GRM1552C1H8R0BZ01D	K22178295	VERSION D	7-	B	b2
C 1091	CHIP CAP.	150pF	50V	CH	GRM1552C1H151JA01D	K22178240		1-	B	a3
C 1092	CHIP CAP.	0.01uF	50V	B	GRM188B11H103KA01D	K22174823		1-	B	a2
C 1093	CHIP CAP.	220pF	50V	CH	GRM1552C1H221JA01D	K22179713		1-	A	B2
C 1094	CHIP CAP.	0.01uF	25V	B	GRM155B11E103KA01D	K22148834		1-	A	B4
C 1095	CHIP CAP.	0.01uF	25V	B	GRM155B11E103KA01D	K22148834		1-	B	a3
C 1097	CHIP TA.CAP.	1uF	16V		F931C105MAA	K78120082		1-	B	a2
C 1098	CHIP CAP.	0.01uF	25V	B	GRM155B11E103KA01D	K22148834		1-	A	B4
C 1099	CHIP CAP.	150pF	50V	CH	GRM1552C1H151JA01D	K22178240		1-	B	b2
C 1100	CHIP CAP.	56pF	50V	CH	GRM1552C1H560JD01D	K22178230		1-6	B	b2
C 1100	CHIP CAP.	33pF	50V	CH	GRM1552C1H330JZ01D	K22178224	EU	7-	B	b2
C 1100	CHIP CAP.	56pF	50V	CH	GRM1552C1H560JD01D	K22178230	VTX / EXP	7-	B	b2
C 1101	CHIP CAP.	0.001uF	50V	B	GRM155B11H102KA01D	K22178809		1-	B	a3
C 1103	CHIP CAP.	150pF	50V	CH	GRM1552C1H151JA01D	K22178240		1-	B	a3
C 1104	CHIP CAP.	150pF	50V	CH	GRM1552C1H151JA01D	K22178240		1-	B	a3
C 1106	CHIP CAP.	10pF	50V	CH	GRM1552C1H100JZ01D	K22178212		1	B	b2
C 1106	CHIP CAP.	10pF	50V	CH	GRM1552C1H100BZ01D	K22178297		2-	B	b2
C 1107	CHIP CAP.	100pF	50V	CH	GRM1552C1H101JD01D	K22178236		1-	B	b2
C 1108	CHIP CAP.	0.001uF	50V	B	GRM155B11H102KA01D	K22178809		1-	A	B4
C 1109	CHIP CAP.	0.0047uF	50V	B	GRM155B11H472KA01D	K22178838		1-	A	A4
C 1109	CHIP CAP.	0.0033uF	50V	B	GRM155B11H332KA01D	K22178815		21-	A	A4
C 1110	CHIP CAP.	15pF	50V	CH	GRM1552C1H150JZ01D	K22178216		1-6	B	b2
C 1110	CHIP CAP.	12pF	50V	CH	GRM1552C1H120JZ01D	K22178214	VERSION A	7-	B	b2
C 1110	CHIP CAP.	15pF	50V	CH	GRM1552C1H150JZ01D	K22178216	VERSION D	7-	B	b2
C 1112	CHIP CAP.	0.01uF	25V	B	GRM155B11E103KA01D	K22148834		1-	A	A4
C 1112	CHIP CAP.	0.033uF	10V	B	GRM155B11A333KA01D	K22108803		21-	A	A4
C 1113	CHIP CAP.	150pF	50V	CH	GRM1552C1H151JA01D	K22178240		1-	A	B2

REF.	DESCRIPTION	VALUE	V/W	TOL.	MFR'S DESIG	VXSTD P/N	VERS.	LOT.	SIDE	LAY ADR
C 1114	CHIP CAP.	0.001uF	50V	B	GRM155B11H102KA01D	K22178809		1-	A	A5
C 1115	CHIP CAP.	0.1uF	10V	B	GRM155B11A104KA01D	K22108802		1-	B	b2
C 1116	CHIP TA.CAP.	1uF	16V		F931C105MAA	K78120082		1-	A	B2
C 1117	CHIP CAP.	10pF	50V	CH	GRM1552C1H100JZ01D	K22178212		1-	B	a3
C 1118	CHIP CAP.	0.0047uF	50V	B	GRM155B11H472KA01D	K22178838		1-	A	B4
C 1119	CHIP CAP.	4pF	50V	CH	GRM1552C1H4R0CZ01D	K22178206		1	B	b2
C 1119	CHIP CAP.	4pF	50V	CH	GRM1552C1H4R0BZ01D	K22178291		2-5	B	b2
C 1119	CHIP CAP.	2pF	50V	CK	GRM1554C1H2R0BZ01D	K22178289	VERSION A	6	B	b2
C 1119	CHIP CAP.	3pF	50V	CJ	GRM1553C1H3R0BZ01D	K22178290	VERSION A	7-	B	b2
C 1119	CHIP CAP.	4pF	50V	CH	GRM1552C1H4R0BZ01D	K22178291	VERSION D	6-	B	b2
C 1120	CHIP CAP.	7pF	50V	CH	GRM1552C1H7R0DZ01D	K22178209		1-	B	a3
C 1121	CHIP CAP.	0.1uF	10V	B	GRM155B11A104KA01D	K22108802		1-	A	B4
C 1122	CHIP CAP.	0.047uF	10V	B	GRM155B11A473KA01D	K22108801		1-	A	A4
C 1123	CHIP CAP.	0.001uF	50V	B	GRM155B11H102KA01D	K22178809		1-	A	A5
C 1124	CHIP CAP.	2.2uF	10V	B	GRM188B31A225KE18D	K22104805		1-	A	A4
C 1125	CHIP CAP.	8pF	50V	CH	GRM1552C1H8R0DZ01D	K22178210		1	B	b3
C 1125	CHIP CAP.	8pF	50V	CH	GRM1552C1H8R0BZ01D	K22178295		2-5	B	b3
C 1125	CHIP CAP.	7pF	50V	CH	GRM1552C1H7R0BZ01D	K22178294	VERSION A	6-	B	b3
C 1125	CHIP CAP.	8pF	50V	CH	GRM1552C1H8R0BZ01D	K22178295	VERSION D	6-	B	b3
C 1127	CHIP CAP.	6pF	50V	CH	GRM1552C1H6R0DZ01D	K22178208		1	B	b3
C 1127	CHIP CAP.	6pF	50V	CH	GRM1552C1H6R0BZ01D	K22178293		2-	B	b3
C 1128	CHIP CAP.	150pF	50V	CH	GRM1552C1H151JA01D	K22178240		1-	B	a3
C 1129	CHIP CAP.	47pF	50V	CH	GRM1552C1H470JZ01D	K22178228		1-	A	B3
C 1131	CHIP CAP.	150pF	50V	CH	GRM1552C1H151JA01D	K22178240		1-	B	a3
C 1133	CHIP TA.CAP.	4.7uF	20V		F931D475MAA	K78130070		1-5	A	A1
C 1133	CHIP TA.CAP.	4.7uF	16V		F921C475MAA	K78120096		6-	A	A1
C 1134	CHIP CAP.	0.01uF	25V	B	GRM155B11E103KA01D	K22148834		1-	B	a3
C 1135	CHIP CAP.	150pF	50V	CH	GRM1552C1H151JA01D	K22178240		1-	B	a3
C 1136	CHIP CAP.	0.001uF	50V	B	GRM155B11H102KA01D	K22178809		1-	A	B4
C 1137	CHIP CAP.	10pF	50V	CH	GRM1552C1H100JZ01D	K22178212		1-	B	a3
C 1138	CHIP CAP.	0.001uF	50V	B	GRM155B11H102KA01D	K22178809		1-	A	A2
C 1139	CHIP CAP.	0.01uF	25V	B	GRM155B11E103KA01D	K22148834		1-	B	a3
C 1140	CHIP CAP.	0.1uF	10V	B	GRM155B11A104KA01D	K22108802		1-	A	B4
C 1141	CHIP CAP.	0.1uF	10V	B	GRM155B11A104KA01D	K22108802		1-	A	B2
C 1143	CHIP CAP.	150pF	50V	CH	GRM1552C1H151JA01D	K22178240		1-	B	a3
C 1146	CHIP CAP.	1uF	6.3V	B	GRM188B10J105KA01D	K22084801		1-	A	C4
C 1147	CHIP CAP.	7pF	50V	CH	GRM1552C1H7R0DZ01D	K22178209		1-	B	a4
C 1148	CHIP CAP.	0.01uF	25V	B	GRM155B11E103KA01D	K22148834		1-	A	A2
C 1149	CHIP CAP.	0.001uF	50V	B	GRM155B11H102KA01D	K22178809		1-	A	B2
C 1152	CHIP CAP.	1uF	6.3V	B	GRM188B10J105KA01D	K22084801		1-	A	B2
C 1153	CHIP CAP.	56pF	50V	CH	GRM1552C1H560JD01D	K22178230		1-	A	B3
C 1155	CHIP CAP.	150pF	50V	CH	GRM1552C1H151JA01D	K22178240		1-	B	a4
C 1159	CHIP CAP.	10pF	50V	CH	GRM1552C1H100JZ01D	K22178212		1-	B	a3
C 1160	CHIP CAP.	10pF	50V	CH	GRM1552C1H100JZ01D	K22178212		1-	B	c5
C 1161	CHIP CAP.	10pF	50V	CH	GRM1552C1H100JZ01D	K22178212		1-	B	c5
C 1162	CHIP CAP.	0.001uF	50V	B	GRM155B11H102KA01D	K22178809		1-	A	C3
C 1163	CHIP CAP.	10pF	50V	CH	GRM1552C1H100JZ01D	K22178212		1-	B	a4
C 1164	CHIP CAP.	0.01uF	25V	B	GRM155B11E103KA01D	K22148834		1-	A	B4
C 1167	CHIP CAP.	0.0047uF	50V	B	GRM155B11H472KA01D	K22178838		1-	A	C3
C 1169	CHIP CAP.	0.0022uF	50V	B	GRM155B11H222KA01D	K22178813		1-	A	C3
C 1170	CHIP CAP.	0.001uF	50V	B	GRM155B11H102KA01D	K22178809		1-	B	b3
C 1171	CHIP CAP.	150pF	50V	CH	GRM1552C1H151JA01D	K22178240		1-	B	b3
C 1172	CHIP CAP.	3pF	50V	CJ	GRP1553C1H3R0CZ01E	K22178205		1-	B	b5
C 1173	CHIP CAP.	150pF	50V	CH	GRM1552C1H151JA01D	K22178240		1-	B	b3
C 1174	CHIP CAP.	0.1uF	10V	B	GRM155B11A104KA01D	K22108802		1-	A	C3
C 1175	CHIP CAP.	12pF	50V	CH	GRM1552C1H120JZ01D	K22178214		1-	A	C3
C 1176	CHIP CAP.	7pF	50V	CH	GRM1552C1H7R0DZ01D	K22178209		1-	B	a4
C 1177	CHIP CAP.	150pF	50V	CH	GRM1552C1H151JA01D	K22178240		1-	B	b3
C 1178	CHIP CAP.	7pF	50V	CH	GRM1552C1H7R0DZ01D	K22178209		1-	B	b3
C 1179	CHIP CAP.	1uF	6.3V	B	GRM188B10J105KA01D	K22084801		1-	A	A5
C 1180	CHIP CAP.	7pF	50V	CH	GRM1552C1H7R0DZ01D	K22178209		1-	B	a4
C 1182	CHIP CAP.	150pF	50V	CH	GRM1552C1H151JA01D	K22178240		1-	B	a4
C 1183	CHIP CAP.	0.1uF	10V	B	GRM155B11A104KA01D	K22108802		1-	A	A5
C 1184	CHIP CAP.	150pF	50V	CH	GRM1552C1H151JA01D	K22178240		1-	B	a4
C 1185	CHIP CAP.	0.1uF	10V	B	GRM155B11A104KA01D	K22108802		1-	A	B4
C 1186	CHIP CAP.	1pF	50V	CK	GRM1554C1H1R0CZ01D	K22178202		1-	B	b3
C 1187	CHIP CAP.	0.001uF	50V	B	GRM155B11H102KA01D	K22178809		1-	A	C3

MAIN Unit

Parts List

REF.	DESCRIPTION	VALUE	V/W	TOL.	MFR'S DESIG	VXSTD P/N	VERS.	LOT.	SIDE	LAY ADR
C 1188	CHIP CAP.	150pF	50V	CH	GRM1552C1H151JA01D	K22178240		1-	B	a4
C 1189	CHIP CAP.	8pF	50V	CH	GRM1552C1H8R0DZ01D	K22178210		1-	B	b3
C 1190	CHIP CAP.	0.001uF	50V	B	GRM155B11H102KA01D	K22178809		1-	A	B3
C 1191	CHIP CAP.	1pF	50V	CK	GRM1554C1H1R0CZ01D	K22178202		1	B	a4
C 1191	CHIP CAP.	1pF	50V	CK	GRM1554C1H1R0BZ01D	K22178287		2-	B	a4
C 1192	CHIP CAP.	180pF	50V	CH	GRM1552C1H181JA01D	K22179711		1-5	A	C3
C 1192	CHIP CAP.	180pF	50V	CH	GRM1552C1H181JA01D	K22179711	EU VER. A	7-	A	C3
C 1192	CHIP CAP.	180pF	50V	CH	GRM1552C1H181JA01D	K22179711	EXP VER. A	8-	A	C3
C 1192	CHIP CAP.	180pF	50V	CH	GRM1552C1H181JA01D	K22179711	VERSION D	6-	A	C3
C 1192	CHIP CAP.	180pF	50V	CH	GRM1552C1H181JA01D	K22179711	VTX VER. A	8-	A	C3
C 1193	CHIP CAP.	1pF	50V	CK	GRM1554C1H1R0BZ01D	K22178287		1-	B	a4
C 1194	CHIP CAP.	0.01uF	25V	B	GRM155B11E103KA01D	K22148834		1-	B	a5
C 1195	CHIP CAP.	0.5pF	50V	CK	GRM1554C1HR50BZ01D	K22178285		1-	B	a4
C 1196	CHIP CAP.	0.1uF	10V	B	GRM155B11A104KA01D	K22108802		1-	A	C3
C 1197	CHIP CAP.	0.01uF	25V	B	GRM155B11E103KA01D	K22148834		1-	B	a4
C 1198	CHIP CAP.	4pF	50V	CH	GRM1552C1H4R0BZ01D	K22178291		1-	B	a4
C 1200	CHIP CAP.	5pF	50V	CH	GRM1552C1H5R0BZ01D	K22178292		1-	B	a4
C 1201	CHIP CAP.	150pF	50V	CH	GRM1552C1H151JA01D	K22178240		1-	B	a5
C 1202	CHIP CAP.	0.01uF	25V	B	GRM155B11E103KA01D	K22148834		1-	B	b4
C 1203	CHIP CAP.	5pF	50V	CH	GRM1552C1H5R0CZ01D	K22178207		1	B	a5
C 1203	CHIP CAP.	5pF	50V	CH	GRM1552C1H5R0BZ01D	K22178292		2-	B	a5
C 1204	CHIP CAP.	15pF	50V	CH	GRM1552C1H150JZ01D	K22178216		1-	B	a5
C 1205	CHIP CAP.	12pF	50V	CH	GRM1552C1H120JZ01D	K22178214		1-	B	a4
C 1206	CHIP CAP.	150pF	50V	CH	GRM1552C1H151JA01D	K22178240		1-	B	a4
C 1207	CHIP CAP.	220pF	50V	CH	GRM1552C1H221JA01D	K22179713		1-5	A	B3
C 1207	CHIP CAP.	220pF	50V	CH	GRM1552C1H221JA01D	K22179713	EU VER. A	7-	A	B3
C 1207	CHIP CAP.	220pF	50V	CH	GRM1552C1H221JA01D	K22179713	EXP VER. A	8-	A	B3
C 1207	CHIP CAP.	220pF	50V	CH	GRM1552C1H221JA01D	K22179713	VERSION D	6-	A	B3
C 1207	CHIP CAP.	220pF	50V	CH	GRM1552C1H221JA01D	K22179713	VTX VER. A	8-	A	B3
C 1208	CHIP CAP.	0.0022uF	50V	B	GRM155B11H222KA01D	K22178813		1-	A	B3
C 1209	CHIP CAP.	150pF	50V	CH	GRM1552C1H151JA01D	K22178240		1-	B	a5
C 1210	CHIP CAP.	150pF	50V	CH	GRM1552C1H151JA01D	K22178240		1-	B	a5
C 1211	CHIP TA.CAP.	10uF	10V		F931A106MAA	K78100078		1-	B	b5
C 1214	CHIP CAP.	27pF	50V	CH	GRM1552C1H270JZ01D	K22178222		1-5	B	a5
C 1214	CHIP CAP.	33pF	50V	CH	GRM1552C1H330JZ01D	K22178224	VERSION A	6-	B	a5
C 1214	CHIP CAP.	27pF	50V	CH	GRM1552C1H270JZ01D	K22178222	VERSION D	6-	B	a5
C 1217	CHIP CAP.	0.1uF	10V	B	GRM155B11A104KA01D	K22108802		1-	A	B4
C 1219	CHIP CAP.	0.001uF	50V	B	GRM155B11H102KA01D	K22178809		1-	B	b4
C 1221	CHIP CAP.	15pF	50V	CH	GRM1552C1H150JZ01D	K22178216		1-	B	a5
C 1223	CHIP TA.CAP.	10uF	10V		F931A106MAA	K78100078		1-	B	a4
C 1224	CHIP CAP.	2pF	50V	CK	GRM1554C1H2R0CZ01D	K22178204		1	B	a5
C 1224	CHIP CAP.	2pF	50V	CK	GRM1554C1H2R0BZ01D	K22178289		2-5	B	a5
C 1224	CHIP CAP.	1.5pF	50V	CK	GRM1554C1H1R5BZ01D	K22178288	VERSION A	6-	B	a5
C 1224	CHIP CAP.	2pF	50V	CK	GRM1554C1H2R0BZ01D	K22178289	VERSION D	6-	B	a5
C 1225	CHIP CAP.	1.5pF	50V	CK	GRM1554C1H1R5CZ01D	K22178203		1	B	a5
C 1225	CHIP CAP.	1.5pF	50V	CK	GRM1554C1H1R5BZ01D	K22178288		2-5	B	a5
C 1225	CHIP CAP.	1pF	50V	CK	GRM1554C1H1R0BZ01D	K22178287	VERSION A	6-	B	a5
C 1225	CHIP CAP.	1.5pF	50V	CK	GRM1554C1H1R5BZ01D	K22178288	VERSION D	6-	B	a5
C 1227	CHIP CAP.	0.01uF	25V	B	GRM155B11E103KA01D	K22148834		1-	A	B3
C 1228	CHIP CAP.	0.01uF	25V	B	GRM155B11E103KA01D	K22148834		1-	B	b4
C 1230	CHIP CAP.	150pF	50V	CH	GRM1552C1H151JA01D	K22178240		1-	B	b4
C 1231	CHIP CAP.	150pF	50V	CH	GRM1552C1H151JA01D	K22178240		1-	B	a5
C 1232	CHIP TA.CAP.	0.22uF	35V		TEESVA1V224M8R	K78160027		1-	B	b5
C 1233	CHIP CAP.	0.1uF	10V	B	GRM155B11A104KA01D	K22108802		1-	A	B4
C 1234	CHIP CAP.	0.001uF	50V	B	GRM155B11H102KA01D	K22178809		1-	A	A1
C 1237	CHIP TA.CAP.	0.22uF	35V		TEESVA1V224M8R	K78160027		1-	B	b5
C 1241	CHIP CAP.	0.01uF	25V	B	GRM155B11E103KA01D	K22148834		1-	B	b3
C 1243	CHIP CAP.	0.047uF	10V	B	GRM155B11A473KA01D	K22108801		1-	B	b3
C 1245	CHIP CAP.	0.1uF	10V	B	GRM155B11A104KA01D	K22108802		1-	A	C4
C 1246	CHIP TA.CAP.	0.1uF	35V		TEESVA1V104M8R	K78160025		1-	B	b5
C 1247	CHIP TA.CAP.	2.2uF	16V		F931C225MAA	K78120083		1-	B	b5
C 1249	CHIP CAP.	0.01uF	25V	B	GRM155B11E103KA01D	K22148834		1-	A	C3
C 1250	CHIP CAP.	0.01uF	25V	B	GRM155B11E103KA01D	K22148834		1-	B	c3
C 1251	CHIP CAP.	39pF	50V	CH	GRM1552C1H390JZ01D	K22178226		1-	B	c3
C 1253	CHIP CAP.	0.01uF	25V	B	GRM155B11E103KA01D	K22148834		1-	B	b3
C 1256	CHIP CAP.	0.01uF	25V	B	GRM155B11E103KA01D	K22148834		1-	A	C4
C 1258	CHIP CAP.	82pF	50V	CH	GRM1552C1H820JD01D	K22178234		1-	B	b3

REF.	DESCRIPTION	VALUE	V/W	TOL.	MFR'S DESIG	VXSTD P/N	VERS.	LOT.	SIDE	LAY ADR
C 1259	CHIP CAP.	0.1uF	10V	B	GRM155B11A104KA01D	K22108802		1-	B	c3
C 1262	CHIP CAP.	270pF	50V	CH	GRM1552C1H271JA01D	K22179715		1-6	B	b3
C 1262	CHIP CAP.	470pF	50V	B	GRM155B11H471KA01D	K22178805		7-	B	b3
C 1263	CHIP CAP.	270pF	50V	CH	GRM1552C1H271JA01D	K22179715		1-6	B	c3
C 1263	CHIP CAP.	470pF	50V	B	GRM155B11H471KA01D	K22178805		7-	B	c3
C 1264	CHIP CAP.	0.01uF	25V	B	GRM155B11E103KA01D	K22148834		1-	B	b5
C 1265	CHIP CAP.	0.001uF	50V	B	GRM155B11H102KA01D	K22178809		1-	B	b5
C 1266	CHIP TA.CAP.	10uF	10V		F931A106MAA	K78100078		1-	B	b3
C 1267	CHIP CAP.	0.022uF	16V	B	GRM155B11C223KA01D	K22128806		1-	A	C4
C 1268	CHIP CAP.	0.001uF	50V	B	GRM155B11H102KA01D	K22178809		1-	B	b5
C 1270	CHIP CAP.	0.01uF	25V	B	GRM155B11E103KA01D	K22148834		1-	B	c3
C 1273	CHIP CAP.	1uF	6.3V	B	GRM155B30J105KE18D	K22088803		1-	A	C4
C 1274	CHIP TA.CAP.	10uF	10V		F931A106MAA	K78100078		1-	B	b5
C 1276	CHIP CAP.	0.0033uF	50V	B	GRM155B11H332KA01D	K22178815		1-	B	b3
C 1277	CHIP CAP.	0.1uF	10V	B	GRM155B11A104KA01D	K22108802		1-	B	b3
C 1278	CHIP CAP.	0.1uF	10V	B	GRM155B11A104KA01D	K22108802		1-	A	B3
C 1279	CHIP CAP.	0.1uF	10V	B	GRM155B11A104KA01D	K22108802		1-	A	B3
C 1280	CHIP CAP.	0.01uF	25V	B	GRM155B11E103KA01D	K22148834		1-	B	b3
C 1281	CHIP CAP.	0.022uF	16V	B	GRM155B11C223KA01D	K22128806		1-6	B	c4
C 1281	CHIP CAP.	0.1uF	10V	B	GRM155B11A104KA01D	K22108802		7-	B	c4
C 1282	CHIP CAP.	0.001uF	50V	B	GRM155B11H102KA01D	K22178809		1-	B	b4
C 1283	CHIP CAP.	0.001uF	50V	B	GRM155B11H102KA01D	K22178809		1-	B	b5
C 1285	CHIP CAP.	100pF	50V	CH	GRM1552C1H101JD01D	K22178236		1-	A	B4
C 1286	CHIP CAP.	0.1uF	10V	B	GRM155B11A104KA01D	K22108802		1-	B	b5
C 1287	CHIP CAP.	33pF	50V	CH	GRM1552C1H330JZ01D	K22178224		1-	B	c5
C 1288	CHIP CAP.	0.01uF	25V	B	GRM155B11E103KA01D	K22148834		1-	A	B3
C 1289	CHIP CAP.	0.01uF	25V	B	GRM155B11E103KA01D	K22148834		1-	B	b4
C 1290	CHIP CAP.	0.1uF	10V	B	GRM155B11A104KA01D	K22108802		1-	A	B4
C 1291	CHIP CAP.	33pF	50V	CH	GRM1552C1H330JZ01D	K22178224		1-	B	c5
C 1292	CHIP CAP.	0.01uF	25V	B	GRM155B11E103KA01D	K22148834		1-	A	B3
C 1293	CHIP CAP.	180pF	50V	CH	GRM1552C1H181JA01D	K22179711		1-	A	C4
C 1294	CHIP CAP.	0.1uF	10V	B	GRM155B11A104KA01D	K22108802		1-	B	b4
C 1295	CHIP CAP.	0.001uF	50V	B	GRM155B11H102KA01D	K22178809		1-	B	b4
C 1296	CHIP CAP.	100pF	50V	CH	GRM1552C1H101JD01D	K22178236		1-	B	c4
C 1297	CHIP CAP.	0.0033uF	50V	B	GRM155B11H332KA01D	K22178815		1-	A	B4
C 1298	CHIP CAP.	0.0022uF	50V	B	GRM155B11H222KA01D	K22178813		1-	A	B3
C 1299	CHIP CAP.	0.1uF	10V	B	GRM155B11A104KA01D	K22108802		1-	B	c4
C 1300	CHIP CAP.	0.01uF	25V	B	GRM155B11E103KA01D	K22148834		1-	A	B3
C 1301	CHIP CAP.	0.01uF	25V	B	GRM155B11E103KA01D	K22148834		1-	A	B3
C 1302	CHIP CAP.	0.0033uF	50V	B	GRM155B11H332KA01D	K22178815		1-	A	C4
C 1303	CHIP CAP.	0.022uF	16V	B	GRM155B11C223KA01D	K22128806		1-	A	B4
C 1304	CHIP CAP.	0.01uF	25V	B	GRM155B11E103KA01D	K22148834		1-	B	b4
C 1314	CHIP CAP.	0.001uF	50V	B	GRM155B11H102KA01D	K22178809		1-	A	A2
C 1315	CHIP CAP.	0.001uF	50V	B	GRM155B11H102KA01D	K22178809		1-	B	c2
C 1316	CHIP CAP.	0.001uF	50V	B	GRM155B11H102KA01D	K22178809		1-	B	c3
C 1317	CHIP TA.CAP.	10uF	10V		TEESVP1A106M8R	K78100074		1-6	A	C3
C 1317	CHIP TA.CAP.	10uF	10V		F921A106MPA	K78100089		7-	A	C3
C 1318	CHIP CAP.	0.1uF	10V	B	GRM155B11A104KA01D	K22108802		1-	A	B4
C 1319	CHIP CAP.	1uF	6.3V	B	GRM188B10J105KA01D	K22084801		1-	B	b2
C 1322	CHIP CAP.	150pF	50V	CH	GRM1552C1H151JA01D	K22178240		1-6	B	c2
C 1322	CHIP CAP.	100pF	50V	CH	GRM1552C1H101JD01D	K22178236	EU	7-	B	c2
C 1322	CHIP CAP.	150pF	50V	CH	GRM1552C1H151JA01D	K22178240	VTX/EXP	7-	B	c2
C 1324	CHIP CAP.	12pF	50V	CH	GRM1882C1H120JA01D	K22174213	VERSION A	7-	B	b2
C 1325	CHIP CAP.	10pF	50V	CH	GRM1882C1H100JA01D	K22174211	VERSION A	7-	B	b2
C 1327	CHIP CAP.	9pF	50V	CH	GRM1882C1H9R0DZ01D	K22174210		1-5	B	b2
C 1327	CHIP CAP.	9pF	50V	CH	GRM1882C1H9R0DZ01D	K22174210	VERSION D	6-	B	b2
C 1328	CHIP CAP.	9pF	50V	CH	GRM1882C1H9R0DZ01D	K22174210		1-5	B	b2
C 1328	CHIP CAP.	9pF	50V	CH	GRM1882C1H9R0DZ01D	K22174210	VERSION D	6	B	b2
C 1328	CHIP CAP.	9pF	50V	CH	GRM1882C1H9R0DZ01D	K22174210		7-	B	b2
C 1329	CHIP CAP.	4pF	50V	CH	GRM1882C1H4R0CZ01D	K22174205		1-5	B	b2
C 1329	CHIP CAP.	5pF	50V	CH	GRM1882C1H5R0CZ01D	K22174206	VERSION A	6	B	b2
C 1329	CHIP CAP.	4pF	50V	CH	GRM1882C1H4R0CZ01D	K22174205	VERSION D	6-	B	b2
C 1331	CHIP CAP.	0.01uF	25V	B	GRM155B11E103KA01D	K22148834		1-	B	b3
C 1332	CHIP CAP.	150pF	50V	CH	GRM1552C1H151JA01D	K22178240		1-	B	a3
C 1333	CHIP CAP.	9pF	50V	CH	GRM1882C1H9R0DZ01D	K22174210		1-5	B	b2
C 1333	CHIP CAP.	27pF	50V	CH	GRM1882C1H270JA01D	K22174221	VERSION A	6	B	b2
C 1333	CHIP CAP.	9pF	50V	CH	GRM1882C1H9R0DZ01D	K22174210	VERSION D	6	B	b2

MAIN Unit

Parts List

REF.	DESCRIPTION	VALUE	V/W	TOL.	MFR'S DESIG	VXSTD P/N	VERS.	LOT.	SIDE	LAY ADR
C 1333	CHIP CAP.	9pF	50V	CH	GRM1882C1H9R0DZ01D	K22174210		7-	B	b2
C 1335	CHIP CAP.	0.01uF	25V	B	GRM155B11E103KA01D	K22148834		1-	B	a3
C 1336	CHIP CAP.	1uF	16V	B	C1608JB1C105KT	K22124813		1-	A	B3
C 1337	CHIP CAP.	10pF	50V	CH	GRM1552C1H100JZ01D	K22178212		1	B	b3
C 1337	CHIP CAP.	10pF	50V	CH	GRM1552C1H100BZ01D	K22178297		2-5	B	b3
C 1337	CHIP CAP.	6pF	50V	CH	GRM1552C1H6R0BZ01D	K22178293	VERSION A	6-	B	b3
C 1337	CHIP CAP.	10pF	50V	CH	GRM1552C1H100BZ01D	K22178297	VERSION D	6-	B	b3
C 1338	CHIP TA.CAP.	10uF	10V		TEESVP1A106M8R	K78100074		1-6	B	b4
C 1338	CHIP TA.CAP.	10uF	10V		F921A106MPA	K78100089		7-	B	b4
C 1340	CHIP TA.CAP.	10uF	10V		F931A106MAA	K78100078		1-	A	A2
C 1341	CHIP CAP.	0.1uF	10V	B	GRM155B11A104KA01D	K22108802		1-	B	a4
C 1342	CHIP CAP.	0.001uF	50V	B	GRM155B11H102KA01D	K22178809		1-	B	a4
C 1343	CHIP TA.CAP.	10uF	10V		TEESVP1A106M8R	K78100074		1-6	A	B3
C 1343	CHIP TA.CAP.	10uF	10V		F921A106MPA	K78100089		7-	A	B3
C 1344	CHIP CAP.	150pF	50V	CH	GRM1552C1H151JA01D	K22178240		1-	B	b2
C 1345	CHIP CAP.	1uF	6.3V	B	GRM155B30J105KE18D	K22088803		1-	A	B4
C 1347	CHIP CAP.	0.001uF	50V	B	GRM155B11H102KA01D	K22178809		1-	A	A5
C 1349	CHIP CAP.	0.001uF	50V	B	GRM155B11H102KA01D	K22178809		1-	A	B1
C 1350	CHIP CAP.	0.1uF	10V	B	GRM155B11A104KA01D	K22108802		1-	A	A3
C 1353	CHIP CAP.	0.001uF	50V	B	GRM155B11H102KA01D	K22178809		1-	A	A5
C 1356	CHIP CAP.	150pF	50V	CH	GRM1552C1H151JA01D	K22178240		1-	A	C2
C 1357	CHIP CAP.	150pF	50V	CH	GRM1552C1H151JA01D	K22178240		1-	B	a3
C 1358	CHIP CAP.	0.001uF	50V	B	GRM155B11H102KA01D	K22178809		1-	B	a3
C 1359	CHIP CAP.	150pF	50V	CH	GRM1552C1H151JA01D	K22178240		1-	B	a3
C 1360	CHIP CAP.	150pF	50V	CH	GRM1552C1H151JA01D	K22178240		1-	B	a3
C 1361	CHIP CAP.	0.01uF	25V	B	GRM155B11E103KA01D	K22148834		1-	A	C4
C 1364	CHIP CAP.	1uF	6.3V	B	GRM155B30J105KE18D	K22088803		1-	A	A4
C 1365	CHIP CAP.	33pF	50V	CH	GRM1552C1H330JZ01D	K22178224	VERSION A	6		
C 1365	CHIP CAP.	47pF	50V	CH	GRM1552C1H470JZ01D	K22178228	VERSION A	7-		
C 1366	CHIP CAP.	150pF	50V	CH	GRM1552C1H151JA01D	K22178240	VERSION A	7-		
CD1001	CERAMIC DISC				JTBM450CX24	H7901530		1-	B	c3
CF1001	CERAMIC FILTER				LTM450FW	H3900572		1-	A	A2
D 1002	DIODE				HVU131 TRF-E	G2070462		1-	B	b1
D 1003	DIODE				DA221 TL	G2070178		1-	A	B2
D 1004	DIODE				RLS135 TE-11	G2070128		1-	B	c1
D 1005	DIODE				RLS135 TE-11	G2070128		1-	B	c1
D 1007	DIODE				1SV331(TPH3.F)	G2071044		1-	B	c2
D 1008	DIODE				1SV331(TPH3.F)	G2071044		1-	B	c2
D 1009	DIODE				1SS400 TE61	G2070634		1-	A	A2
D 1010	DIODE				EDZ TE-61 3.9B	G2071004		1-	A	B2
D 1011	DIODE				1SS400 TE61	G2070634		1-	A	A1
D 1012	DIODE				DAN222 TL	G2070174		1-	B	a4
D 1013	DIODE				UDZS TE-17 4.3B	G2070874		1-	A	A2
D 1014	DIODE				HVC383B TRF-E	G2070922		1-	B	a4
D 1018	DIODE				1SS400 TE61	G2070634		1-	B	a4
D 1019	DIODE				DA221 TL	G2070178		1-	B	b3
D 1020	DIODE				1SV323(TPH3.F)	G2071006		1-	B	a5
D 1021	DIODE				1SV323(TPH3.F)	G2071006		1-	B	a5
D 1022	DIODE				1SV323(TPH3.F)	G2071006		1-	B	a5
D 1023	DIODE				1SV323(TPH3.F)	G2071006		1-	B	a5
D 1024	DIODE				1SV323(TPH3.F)	G2071006		1-	B	a5
D 1025	DIODE				1SV323(TPH3.F)	G2071006		1-	B	a5
D 1026	LED				LTST-S326KGRKT	G2071172		1-	A	A1
D 1028	DIODE				DA221 TL	G2070178		1-	A	C4
D 1029	DIODE				1SS400G T2R	G2070934		1-	B	c3
D 1030	DIODE				1SV331(TPH3.F)	G2071044		1-	B	b2
D 1031	DIODE				1SV331(TPH3.F)	G2071044		1-	B	b3
D 1035	DIODE				DA221 TL	G2070178		1-	B	a3
F 1001	CHIP FUSE	3.15A			FHC16 322ADTP	Q0000118		1-	A	B1
HS1001	HEATSINK				1.35t-5-6	RA073610A		1-	B	a2
J 1001	SPRING CONNECTOR					R0152490		1-	B	c1
J 1002	CONNECTOR				HSJ1594-010055	P1090896		1-	B	a2
L 1001	COIL	0.014uH			AS050425-14NJ	L0022827		1-	B	c1
L 1002	COIL	0.014uH			AS050425-14NJ	L0022827		1-	B	c1
L 1003	COIL	0.014uH			AS050425-14NJ	L0022827		1-	B	b1
L 1004	M.RFC	0.39uH		2%	C1608CB-R39G-RF	L1691107		1-	B	b1
L 1005	COIL	0.017uH			AS030616-17NK	L0022678		1-	B	b1

REF.	DESCRIPTION	VALUE	V/W	TOL.	MFR'S DESIG	VXSTD P/N	VERS.	LOT.	SIDE	LAY ADR
L 1006	M.RFC	0.015uH			HK1608 15NJ-T	L1690518		1-	B	b1
L 1007	COIL	0.0054uH			AS050321-5R4NJ	L0022581		1-	B	b2
L 1009	COIL	0.047uH			AS030821-47NK	L0022588		1-	B	b2
L 1010	COIL	0.013uH			AS030516-13NK	L0022762		1-5	B	c2
L 1010	COIL	0.017uH			AS030616-17NK	L0022678	VERSION A	6-	B	c2
L 1010	COIL	0.013uH			AS030516-13NK	L0022762	VERSION D	6-	B	c2
L 1011	COIL	0.013uH			AS030516-13NK	L0022762		1-5	B	c2
L 1011	COIL	0.017uH			AS030616-17NK	L0022678	VERSION A	6-	B	c2
L 1011	COIL	0.013uH			AS030516-13NK	L0022762	VERSION D	6-	B	c2
L 1014	COIL	0.0033uH			AS050221-3R3NK	L0022635		1-5	B	a3
L 1014	COIL	0.0054uH			AS050321-5R4NJ	L0022581	VERSION A	6-	B	a3
L 1014	COIL	0.0033uH			AS050221-3R3NK	L0022635	VERSION D	6-	B	a3
L 1015	M.RFC	0.068uH			HK1608 68NJ-T	L1690526		1-	B	b2
L 1016	M.RFC	0.01uH			HK1608 10NJ-T	L1690516		1-	B	a3
L 1017	COIL	0.013uH			AS030516-13NK	L0022762		1-5	B	b2
L 1017	COIL	0.017uH			AS030616-17NK	L0022678	VERSION A	6-	B	b2
L 1017	COIL	0.013uH			AS030516-13NK	L0022762	VERSION D	6-	B	b2
L 1018	COIL	0.013uH			AS030516-13NK	L0022762		1-5	B	b3
L 1018	COIL	0.017uH			AS030616-17NK	L0022678	VERSION A	6-	B	b3
L 1018	COIL	0.013uH			AS030516-13NK	L0022762	VERSION D	6-	B	b3
L 1019	M.RFC	0.015uH			HK1608 15NJ-T	L1690518		1-	B	a3
L 1021	M.RFC	0.015uH			HK1608 15NJ-T	L1690518		1-	B	a4
L 1023	M.RFC	0.047uH			HK1608 47NJ-T	L1690524		1-	B	a4
L 1024	CHIP COIL	33uH		5%	NLV-25T-330J-PF	L1691442		1-	B	c4
L 1025	M.RFC	0.022uH		2%	C1608CB-22NG-RF	L1691036		1-5	B	b3
L 1025	M.RFC	0.01uH		2%	C1608CB-10NG-RF	L1691032	VERSION A	6-	B	b3
L 1025	M.RFC	0.022uH		2%	C1608CB-22NG-RF	L1691036	VERSION D	6-	B	b3
L 1026	M.RFC	0.027uH			HK1608 27NJ-T	L1690521		1-	B	a3
L 1027	M.RFC	0.82uH			LK1608 R82K-T	L1690417		1-	B	b3
L 1028	M.RFC	0.022uH			HK1608 22NJ-T	L1690520		1-	B	a4
L 1029	M.RFC	0.022uH			HK1608 22NJ-T	L1690520		1-	B	a4
L 1030	M.RFC	0.39uH		2%	C1608CB-R39G-RF	L1691107		1-	B	a4
L 1031	M.RFC	0.39uH		2%	C1608CB-R39G-RF	L1691107		1-	B	a5
L 1032	COIL				E2 0.35-1.6-4.5T-L	L0022577		1-5	B	a5
L 1032	COIL				E2 0.35-1.6-5.5T-L	L0022616	VERSION A	6-	B	a5
L 1032	COIL				E2 0.35-1.6-4.5T-L	L0022577	VERSION D	6-	B	a5
L 1033	COIL				E2 0.35-1.6-4.5T-L	L0022577		1-5	B	a5
L 1033	COIL				E2 0.35-1.6-5.5T-L	L0022616	VERSION A	6-	B	a5
L 1033	COIL				E2 0.35-1.6-4.5T-L	L0022577	VERSION D	6-	B	a5
L 1036	M.RFC	0.22uH			HK1608 R22J-T	L1690940		1-	B	b4
L 1037	M.RFC	0.22uH			HK1608 R22J-T	L1690940		1-	B	a5
L 1038	M.RFC	3.3uH			LK1608 3R3K-T	L1690686		1-	B	a5
L 1039	M.RFC	0.39uH		2%	C1608CB-R39G-RF	L1691107		1-	B	a5
L 1040	M.RFC	0.22uH			HK1608 R22J-T	L1690940		1-	B	a5
L 1042	M.RFC	0.15uH			HK1608 R15J-T	L1690938		1-	B	c3
L 1049	CHIP COIL	0.056uH			LQW18AN56NJ00D	L1691264		1-	B	c2
L 1050	M.RFC	0.027uH		2%	C1608CB-27NG-RF	L1691037		1-5	B	b2
L 1050	M.RFC	0.039uH		2%	C1608CB-39NG-RF	L1691039	VERSION A	6-	B	b2
L 1050	M.RFC	0.027uH		2%	C1608CB-27NG-RF	L1691037	VERSION D	6-	B	b2
L 1051	M.RFC	4.7uH			LK1608 4R7K-T	L1690688	EU	7-		
MC1001	MIC. ELEMENT				PF0-1055P	M3290045		1-	A	C2
Q 1001	IC				TC74VHC4066AFT	G1094640		1-	A	B3
Q 1002	TRANSISTOR				2SC4617 TL R	G3346178R		1-	A	C2
Q 1003	IC				TAR5S50U(TE85L.F)	G1094097		1-	A	A1
Q 1005	IC				NJM2070M-TE1	G1094509		1-	A	B1
Q 1006	FET				MTM231230L	G3070357		1-	A	B1
Q 1007	TRANSISTOR				2SC4617 TL R	G3346178R		1-	A	B1
Q 1008	FET				MTM231230L	G3070357		1-	A	A1
Q 1009	TRANSISTOR				DTC144EE TL	G3070075		1-	A	A2
Q 1010	FET				RQA0011DNS	G3070392		1-	A	B2
Q 1011	FET				MTM231230L	G3070357		1-	A	A1
Q 1012	IC				M62364FP 600D	G1093033		1-	A	A3
Q 1013	TRANSISTOR				MSG330010L	G3070348		1-	B	b2
Q 1014	TRANSISTOR				DTC144EE TL	G3070075		1-	A	B3
Q 1015	FET				RQA0004PXDQS	G3070391		1-	B	a3
Q 1016	TRANSISTOR				2SC4617 TL R	G3346178R		1-	A	A4
Q 1018	TRANSISTOR				2SC5227-4-TB	G3352278D		1-	B	a3

MAIN Unit

Parts List

REF.	DESCRIPTION	VALUE	V/W	TOL.	MFR'S DESIG	VXSTD P/N	VERS.	LOT.	SIDE	LAY ADR
Q 1020	IC				TAR5S35U(TE85L.F)	G1094096		1-	A	A2
Q 1022	TRANSISTOR				2SC5005-T1	G3350058		1-	B	a4
Q 1023	TRANSISTOR				DTC114TE TL	G3070225		1-	B	c4
Q 1024	FET				3SK293(TE85L,F)	G4802938		1-	B	b3
Q 1025	TRANSISTOR				DTC114TE TL	G3070225		1-	B	a4
Q 1026	IC				UPD78F1142GB	✖		1-	A	A5
Q 1027	TRANSISTOR				2SC5005-T1	G3350058		1-	B	a4
Q 1028	TRANSISTOR				DTA144EE TL	G3070074		1-	A	B4
Q 1029	TRANSISTOR				DTC114TE TL	G3070225		1-	B	a4
Q 1030	FET				2SK508-T1B-A K52	G3805088B		1-	B	a4
Q 1031	TRANSISTOR				DTC114TE TL	G3070225		1-	B	a4
Q 1032	TRANSISTOR				2SC4227-T1 R34	G3342278D		1-	B	a5
Q 1033	TRANSISTOR				2SC5226-4/5-TL	G3352268Z		1-	B	b4
Q 1034	TRANSISTOR				2SC4617 TL R	G3346178R		1-	B	b5
Q 1037	TRANSISTOR				2SC4081 T106	G3340818		1-	A	A1
Q 1038	IC				NJM2591V-TE1	G1094024		1-	B	b3
Q 1042	IC				MB15E03SLPFV1-G-EF-6E1	G1094623		1-	B	b5
Q 1043	TRANSISTOR				DTC144EE TL	G3070075		1-	B	b4
Q 1044	TRANSISTOR				DTC144EE TL	G3070075		1-	B	b4
Q 1045	TRANSISTOR				DTC144EE TL	G3070075		1-	A	B4
Q 1046	IC				NJM12902V-TE1	G1093592		1-	A	B4
Q 1047	IC				NJM12904R-TE1	G1093337		1-	A	B4
Q 1048	IC				NJM12903R-TE1	G1093336		1-	A	C4
Q 1049	IC				NJM12902V-TE1	G1093592		1-	A	C3
Q 1050	IC				NJM12902V-TE1	G1093592		1-	A	B3
Q 1052	IC				NJM12904R-TE1	G1093337		1-	A	B2
Q 1056	FET				2SK3541 T2L	G3835417		1-	A	C3
R 1001	CHIP RES.	100	1/16W	5%	RMC1/16 101JATP	J24185101		1-	A	C1
R 1002	CHIP RES.	0	1/10W	5%	RMC1/10T 000J	J24205000		1-	A	C1
R 1003	CHIP RES.	4.7k	1/16W	5%	RMC1/16S 472JTH	J24189033		1-	B	b1
R 1004	CHIP RES.	0	1/16W	5%	RMC1/16S JPTH	J24189070		1-	A	C2
R 1005	CHIP RES.	0	1/16W	5%	RMC1/16S JPTH	J24189070		1-	A	C2
R 1006	CHIP RES.	2.2k	1/16W	5%	RMC1/16S 222JTH	J24189029		1-	A	C2
R 1007	CHIP RES.	47k	1/16W	5%	RMC1/16S 473JTH	J24189045		1-	A	C3
R 1008	CHIP RES.	0	1/16W	5%	RMC1/16 000JATP	J24185000		1-6	A	C2
R 1008	CHIP RES.	0	1/16W	5%	RMC1/16 000JATP	J24185000	VTX/EXP	7-	A	C2
R 1009	CHIP RES.	0	1/16W	5%	RMC1/16 000JATP	J24185000		1-	A	B2
R 1010	CHIP RES.	47k	1/16W	5%	RMC1/16S 473JTH	J24189045		1-	A	C2
R 1011	CHIP RES.	68	1/16W	5%	RMC1/16S 680JTH	J24189011		1-	B	b1
R 1012	CHIP RES.	47k	1/16W	5%	RMC1/16S 473JTH	J24189045		1-	A	C4
R 1013	CHIP RES.	470	1/16W	5%	RMC1/16S 471JTH	J24189021		1-	A	C2
R 1014	CHIP RES.	2.2k	1/16W	5%	RMC1/16S 222JTH	J24189029		1-	A	C2
R 1015	CHIP RES.	68	1/16W	5%	RMC1/16S 680JTH	J24189011		1-	B	b1
R 1016	CHIP RES.	0.33	1/8W	10%	RMC1/8 R33KTP	J24219001		1-	A	B2
R 1017	CHIP RES.	0.33	1/8W	10%	RMC1/8 R33KTP	J24219001		1-	A	B2
R 1018	CHIP RES.	0.33	1/8W	10%	RMC1/8 R33KTP	J24219001		1-	A	B2
R 1019	CHIP RES.	47k	1/16W	5%	RMC1/16S 473JTH	J24189045		1-	A	C2
R 1021	CHIP RES.	0	1/16W	5%	RMC1/16 000JATP	J24185000		1-	A	B2
R 1022	CHIP RES.	0	1/16W	5%	RMC1/16 000JATP	J24185000		1-	A	B2
R 1023	CHIP RES.	47k	1/16W	5%	RMC1/16S 473JTH	J24189045		1-	A	B2
R 1024	CHIP RES.	10	1/16W	5%	RMC1/16 100JATP	J24185100		1-	A	B1
R 1025	CHIP RES.	33k	1/16W	5%	RMC1/16S 333JTH	J24189043		1-	A	C3
R 1028	CHIP RES.	120k	1/16W	0.5%	MCR01MZPD1203	J24189387		1-	A	B2
R 1029	CHIP RES.	120k	1/16W	0.5%	MCR01MZPD1203	J24189387		1-	A	B2
R 1030	CHIP RES.	330k	1/16W	5%	RMC1/16S 334JTH	J24189055		1-	A	C3
R 1031	CHIP RES.	10k	1/16W	5%	RMC1/16S 103JTH	J24189037		1-	A	C3
R 1033	CHIP RES.	270k	1/16W	0.5%	MCR01MZPD2703	J24189329		1-	A	B2
R 1035	CHIP RES.	47k	1/16W	5%	RMC1/16S 473JTH	J24189045		1-	A	B1
R 1036	CHIP RES.	22k	1/16W	5%	RMC1/16S 223JTH	J24189041		1-	A	B1
R 1037	CHIP RES.	270k	1/16W	0.5%	MCR01MZPD2703	J24189329		1-	A	B2
R 1038	CHIP RES.	22k	1/16W	5%	RMC1/16S 223JTH	J24189041		1-	A	A1
R 1040	CHIP RES.	22k	1/16W	5%	RMC1/16S 223JTH	J24189041		1-	A	A1
R 1041	CHIP RES.	100k	1/16W	5%	RMC1/16S 104JTH	J24189049		1-	B	c2
R 1042	CHIP RES.	100	1/16W	5%	RMC1/16S 101JTH	J24189013		1-	A	B2
R 1043	CHIP RES.	5.6k	1/16W	5%	RMC1/16S 562JTH	J24189034		1-	A	B3
R 1044	CHIP RES.	470	1/16W	5%	RMC1/16S 471JTH	J24189021		1-	A	B2
R 1045	CHIP RES.	10k	1/16W	5%	RMC1/16S 103JTH	J24189037		1-	A	B2

✖: Please contact VERTEX STANDARD.

REF.	DESCRIPTION	VALUE	V/W	TOL.	MFR'S DESIG	VXSTD P/N	VERS.	LOT.	SIDE	LAY ADR
R 1046	CHIP RES.	100k	1/16W	5%	RMC1/16S 104JTH	J24189049		1-	B	c2
R 1047	CHIP RES.	4.7k	1/16W	5%	RMC1/16S 472JTH	J24189033		1-	A	B3
R 1048	CHIP RES.	56k	1/16W	5%	RMC1/16S 563JTH	J24189046		1-	A	A1
R 1049	CHIP RES.	27k	1/16W	0.5%	MCR01MZPD2702	J24189379		1-	A	B3
R 1050	CHIP RES.	33k	1/16W	0.5%	MCR01MZPD3302	J24189380		1-	A	B3
R 1051	CHIP RES.	0	1/16W	5%	RMC1/16S JPTH	J24189070		1-6	B	b2
R 1051	CHIP RES.	15	1/16W	5%	RMC1/16S 150JTH	J24189003	EU	7-	B	b2
R 1051	CHIP RES.	0	1/16W	5%	RMC1/16S JPTH	J24189070	VTX/EXP	7-	B	b2
R 1052	CHIP RES.	33k	1/16W	5%	RMC1/16S 333JTH	J24189043		1-	A	A2
R 1053	CHIP RES.	0	1/16W	5%	RMC1/16S JPTH	J24189070		1-	A	A3
R 1054	CHIP RES.	10k	1/16W	5%	RMC1/16S 103JTH	J24189037		1-	A	B3
R 1055	CHIP RES.	22k	1/16W	5%	RMC1/16S 223JTH	J24189041		1-	B	b2
R 1056	CHIP RES.	1M	1/16W	5%	RMC1/16S 105JTH	J24189061		1-	A	B2
R 1057	CHIP RES.	100k	1/16W	5%	RMC1/16S 104JTH	J24189049		1-	A	A2
R 1058	CHIP RES.	220k	1/16W	5%	RMC1/16S 224JTH	J24189053		1-	A	B4
R 1059	CHIP RES.	2.7k	1/16W	5%	RMC1/16S 272JTH	J24189030		1-	A	A4
R 1060	CHIP RES.	15k	1/16W	5%	RMC1/16S 153JTH	J24189039		1-	A	B4
R 1061	CHIP RES.	1.8k	1/16W	5%	RMC1/16S 182JTH	J24189028		1-	A	A4
R 1063	CHIP RES.	10k	1/16W	5%	RMC1/16S 103JTH	J24189037		1-	A	B5
R 1064	CHIP RES.	820	1/16W	5%	RMC1/16S 821JTH	J24189024		1-5	B	b2
R 1064	CHIP RES.	330	1/16W	5%	RMC1/16S 331JTH	J24189019	VERSION A	6	B	b2
R 1064	CHIP RES.	820	1/16W	5%	RMC1/16S 821JTH	J24189024	VERSION D	6	B	b2
R 1064	CHIP RES.	820	1/16W	5%	RMC1/16S 821JTH	J24189024		7-8	B	b2
R 1064	CHIP RES.	820	1/16W	0.5%	MCR01MZPD8200	J24189361		9-12	B	b2
R 1064	CHIP RES.	820	1/16W	5%	RMC1/16S 821JTH	J24189024		13-	B	b2
R 1065	CHIP RES.	220	1/16W	5%	RMC1/16S 221JTH	J24189017		1-	B	b2
R 1066	CHIP RES.	470	1/16W	5%	RMC1/16S 471JTH	J24189021		1-	B	a3
R 1067	CHIP RES.	47	1/16W	5%	RMC1/16S 470JTH	J24189009		1-	B	b2
R 1068	CHIP RES.	3.3k	1/16W	5%	RMC1/16S 332JTH	J24189031		1-	A	B2
R 1069	CHIP RES.	2.2k	1/16W	5%	RMC1/16S 222JTH	J24189029		1-	B	a3
R 1072	CHIP RES.	820k	1/16W	5%	RMC1/16S 824JTH	J24189060		1-	A	B4
R 1073	CHIP RES.	47	1/16W	5%	RMC1/16S 470JTH	J24189009		1-	B	a3
R 1074	CHIP RES.	1k	1/16W	5%	RMC1/16S 102JTH	J24189025		1-	B	a3
R 1075	CHIP RES.	220	1/16W	5%	RMC1/16S 221JTH	J24189017		1-	B	b2
R 1077	CHIP RES.	68k	1/16W	5%	RMC1/16S 683JTH	J24189047		1-	A	A4
R 1081	CHIP RES.	0	1/16W	5%	RMC1/16S JPTH	J24189070		1-	A	B4
R 1085	CHIP RES.	68k	1/16W	5%	RMC1/16S 683JTH	J24189047		1-	A	A4
R 1085	CHIP RES.	33k	1/16W	5%	RMC1/16S 333JTH	J24189043		21-	A	A4
R 1086	CHIP RES.	220k	1/16W	5%	RMC1/16S 224JTH	J24189053		1-	A	A4
R 1086	CHIP RES.	470k	1/16W	5%	RMC1/16S 474JTH	J24189057		21-	A	A4
R 1088	CHIP RES.	0	1/16W	5%	RMC1/16S JPTH	J24189070		1-	A	B4
R 1091	CHIP RES.	560k	1/16W	5%	RMC1/16S 564JTH	J24189058		1-	A	B3
R 1093	CHIP RES.	390k	1/16W	5%	RMC1/16S 394JTH	J24189056		1-	A	B3
R 1095	CHIP RES.	22	1/16W	5%	RMC1/16S 220JTH	J24189005		1-	B	a3
R 1096	CHIP RES.	22	1/16W	5%	RMC1/16S 220JTH	J24189005		1-	B	a3
R 1097	CHIP RES.	100	1/16W	5%	RMC1/16S 101JTH	J24189013		1-6	B	a3
R 1097	CHIP RES.	330	1/16W	5%	RMC1/16S 331JTH	J24189019	VERSION A	7-	B	a3
R 1097	CHIP RES.	100	1/16W	5%	RMC1/16S 101JTH	J24189013	VERSION D	7-	B	a3
R 1098	CHIP RES.	22	1/16W	5%	RMC1/16S 220JTH	J24189005		1-	B	a3
R 1099	CHIP RES.	330k	1/16W	0.5%	MCR01MZPD3303	J24189330		1-	A	B1
R 1101	CHIP RES.	470k	1/16W	5%	RMC1/16S 474JTH	J24189057		1-	A	B3
R 1103	CHIP RES.	330k	1/16W	0.5%	MCR01MZPD3303	J24189330		1-	A	B1
R 1104	CHIP RES.	10k	1/16W	5%	RMC1/16S 103JTH	J24189037		1-	B	a3
R 1105	CHIP RES.	220k	1/16W	0.5%	MCR01MZPD2203	J24189389		1-	A	B1
R 1106	CHIP RES.	6.8k	1/16W	5%	RMC1/16S 682JTH	J24189035		1-	B	a3
R 1107	CHIP RES.	330	1/16W	5%	RMC1/16S 331JTH	J24189019		1-	B	a3
R 1108	CHIP RES.	100k	1/16W	0.5%	MCR01MZPD1003	J24189386		1-	A	B2
R 1109	CHIP RES.	100k	1/16W	5%	RMC1/16S 104JTH	J24189049		1-	A	C4
R 1109	CHIP RES.	56k	1/16W	5%	RMC1/16S 563JTH	J24189046		21-	A	C4
R 1110	CHIP RES.	330	1/16W	5%	RMC1/16S 331JTH	J24189019		1-	B	a3
R 1111	CHIP RES.	18	1/16W	5%	RMC1/16S 180JTH	J24189004		1-	B	a3
R 1113	CHIP RES.	0	1/16W	5%	RMC1/16S JPTH	J24189070		1-	A	B3
R 1114	CHIP RES.	220k	1/16W	5%	RMC1/16S 224JTH	J24189053		1-	A	B3
R 1114	CHIP RES.	27k	1/16W	5%	RMC1/16S 273JTH	J24189042		21-	A	B3
R 1115	CHIP RES.	330	1/16W	5%	RMC1/16S 331JTH	J24189019		1-	B	a4
R 1120	CHIP RES.	330	1/16W	5%	RMC1/16S 331JTH	J24189019		1-	B	a4
R 1122	CHIP RES.	390k	1/16W	5%	RMC1/16S 394JTH	J24189056		1-	A	B3

MAIN Unit

Parts List

REF.	DESCRIPTION	VALUE	V/W	TOL.	MFR'S DESIG	VXSTD P/N	VERS.	LOT.	SIDE	LAY ADR
R 1124	CHIP RES.	27k	1/16W	5%	RMC1/16S 273JTH	J24189042		1-	B	a4
R 1125	CHIP RES.	0	1/16W	5%	RMC1/16S JPTH	J24189070		1-	B	b3
R 1126	CHIP RES.	18k	1/16W	5%	RMC1/16S 183JTH	J24189040		1-	A	C3
R 1128	CHIP RES.	100k	1/16W	5%	RMC1/16S 104JTH	J24189049		1-	A	A4
R 1129	CHIP RES.	12k	1/16W	5%	RMC1/16S 123JTH	J24189038		1-	A	B4
R 1130	CHIP RES.	0	1/16W	5%	RMC1/16S JPTH	J24189070		1-	B	a3
R 1131	CHIP RES.	100k	1/16W	5%	RMC1/16S 104JTH	J24189049		1-	A	A4
R 1132	CHIP RES.	120k	1/16W	5%	RMC1/16S 124JTH	J24189050		1-	A	C3
R 1133	CHIP RES.	22k	1/16W	5%	RMC1/16S 223JTH	J24189041		1-	A	C3
R 1135	CHIP RES.	18	1/16W	5%	RMC1/16S 180JTH	J24189004		1-	B	a4
R 1136	CHIP RES.	47k	1/16W	5%	RMC1/16S 473JTH	J24189045		1-	B	b3
R 1137	CHIP RES.	18	1/16W	5%	RMC1/16S 180JTH	J24189004		1-	B	a4
R 1138	CHIP RES.	100k	1/16W	5%	RMC1/16S 104JTH	J24189049		1-	B	b3
R 1140	CHIP RES.	100k	1/16W	5%	RMC1/16S 104JTH	J24189049		1-	B	b3
R 1141	CHIP RES.	68k	1/16W	5%	RMC1/16S 683JTH	J24189047		1-	B	b3
R 1142	CHIP RES.	18	1/16W	5%	RMC1/16S 180JTH	J24189004		1-	B	a4
R 1143	CHIP RES.	15k	1/16W	5%	RMC1/16S 153JTH	J24189039		1-	A	C3
R 1144	CHIP RES.	1.8M	1/16W	5%	RMC1/16S 185JTH	J24189064		1-	A	C3
R 1145	CHIP RES.	47	1/16W	5%	RMC1/16S 470JTH	J24189009		1-	B	b3
R 1147	CHIP RES.	100k	1/16W	5%	RMC1/16S 104JTH	J24189049		1-	A	A5
R 1148	CHIP RES.	47k	1/16W	5%	RMC1/16S 473JTH	J24189045		1-	A	A5
R 1149	CHIP RES.	100k	1/16W	5%	RMC1/16S 104JTH	J24189049		1-	A	A4
R 1150	CHIP RES.	22	1/16W	5%	RMC1/16S 220JTH	J24189005		1-	B	b3
R 1152	CHIP RES.	15k	1/16W	5%	RMC1/16S 153JTH	J24189039		1-	A	C3
R 1154	CHIP RES.	680	1/16W	5%	RMC1/16S 681JTH	J24189023		1-	B	b3
R 1155	CHIP RES.	47	1/16W	5%	RMC1/16S 470JTH	J24189009		1-	B	b3
R 1156	CHIP RES.	0	1/16W	5%	RMC1/16S JPTH	J24189070		1-	B	a4
R 1157	CHIP RES.	68k	1/16W	5%	RMC1/16S 683JTH	J24189047		1-	A	C3
R 1158	CHIP RES.	220	1/16W	5%	RMC1/16S 221JTH	J24189017		1-	B	a4
R 1159	CHIP RES.	33k	1/16W	5%	RMC1/16S 333JTH	J24189043		1-	B	a4
R 1161	CHIP RES.	100	1/16W	5%	RMC1/16S 101JTH	J24189013		1-	A	B4
R 1163	CHIP RES.	100k	1/16W	5%	RMC1/16S 104JTH	J24189049		1-	A	B3
R 1164	CHIP RES.	220k	1/16W	5%	RMC1/16S 224JTH	J24189053		1-	B	a4
R 1165	CHIP RES.	150k	1/16W	5%	RMC1/16S 154JTH	J24189051		1-	B	a4
R 1166	CHIP RES.	1k	1/16W	5%	RMC1/16S 102JTH	J24189025		1-	B	a4
R 1167	CHIP RES.	100k	1/16W	5%	RMC1/16S 104JTH	J24189049		1-	A	C3
R 1168	CHIP RES.	470	1/16W	5%	RMC1/16S 471JTH	J24189021		1-	A	B4
R 1169	CHIP RES.	220	1/16W	0.5%	RR0510P-221-D	J24189103		1-	B	a4
R 1170	CHIP RES.	390	1/16W	0.5%	RR0510P-391-D	J24189109		1-	B	a4
R 1171	CHIP RES.	390	1/16W	5%	RMC1/16S 391JTH	J24189020		1-	B	b4
R 1174	CHIP RES.	100	1/16W	0.5%	RR0510P-101-D	J24189095		1-	B	a5
R 1175	CHIP RES.	10k	1/16W	5%	RMC1/16S 103JTH	J24189037		1-6	A	A5
R 1175	CHIP RES.	1k	1/16W	5%	RMC1/16S 102JTH	J24189025		7-	A	A5
R 1175	CHIP RES.	10k	1/16W	5%	RMC1/16S 103JTH	J24189037		21-	A	A5
R 1176	CHIP RES.	47	1/16W	0.5%	RR0510R-470-D	J24189087		1-	B	a5
R 1177	CHIP RES.	6.8k	1/16W	0.5%	RR0510P-682-D	J24189139		1-	B	a5
R 1178	CHIP RES.	56k	1/16W	5%	RMC1/16S 563JTH	J24189046		1-	A	B3
R 1179	CHIP RES.	56k	1/16W	5%	RMC1/16S 563JTH	J24189046		1-5	A	B3
R 1179	CHIP RES.	56k	1/16W	5%	RMC1/16S 563JTH	J24189046	EU VER. A	7-	A	B3
R 1179	CHIP RES.	56k	1/16W	5%	RMC1/16S 563JTH	J24189046	EXP VER. A	8-	A	B3
R 1179	CHIP RES.	56k	1/16W	5%	RMC1/16S 563JTH	J24189046	VERSION D	6-	A	B3
R 1179	CHIP RES.	56k	1/16W	5%	RMC1/16S 563JTH	J24189046	VTX VER. A	8-	A	B3
R 1181	CHIP RES.	5.6k	1/16W	0.5%	RR0510P-562-D	J24189137		1-5	B	a5
R 1181	CHIP RES.	8.2k	1/16W	0.5%	RR0510P-822-D	J24189141	VERSION A	6-	B	a5
R 1181	CHIP RES.	5.6k	1/16W	0.5%	RR0510P-562-D	J24189137	VERSION D	6-	B	a5
R 1182	CHIP RES.	47k	1/16W	5%	RMC1/16S 473JTH	J24189045		1-	B	b4
R 1183	CHIP RES.	0	1/16W	5%	RMC1/16S JPTH	J24189070		1-	B	b4
R 1185	CHIP RES.	470	1/16W	5%	RMC1/16S 471JTH	J24189021		1-	B	b3
R 1186	CHIP RES.	3.3k	1/16W	5%	RMC1/16S 332JTH	J24189031		1-	A	B3
R 1188	CHIP RES.	2.2k	1/16W	5%	RMC1/16S 222JTH	J24189029		1-	B	a4
R 1190	CHIP RES.	22k	1/16W	5%	RMC1/16S 223JTH	J24189041		1-	A	C4
R 1191	CHIP RES.	470	1/16W	5%	RMC1/16S 471JTH	J24189021		1-	B	b5
R 1194	CHIP RES.	22k	1/16W	5%	RMC1/16S 223JTH	J24189041		1-	A	C4
R 1195	CHIP RES.	680k	1/16W	5%	RMC1/16S 684JTH	J24189059		1-9	A	B4
R 1195	CHIP RES.	680k	1/16W	0.5%	MCR01MZPD6803	J24189390		9-11	A	B4
R 1195	CHIP RES.	680k	1/16W	0.5%	MCR01MZPD6803	J24189390		12-14	A	B4
R 1195	CHIP RES.	680k	1/16W	5%	RMC1/16S 684JTH	J24189059		15-	A	B4

Parts List

REF.	DESCRIPTION	VALUE	V/W	TOL.	MFR'S DESIG	VXSTD P/N	VERS.	LOT.	SIDE	LAY ADR
R 1196	CHIP RES.	330	1/16W	5%	RMC1/16S 331JTH	J24189019		1-	A	A1
R 1198	CHIP RES.	1k	1/16W	5%	RMC1/16S 102JTH	J24189025		1-	A	B1
R 1199	CHIP RES.	470	1/16W	5%	RMC1/16S 471JTH	J24189021		1-	B	b5
R 1201	CHIP RES.	1.8k	1/16W	5%	RMC1/16S 182JTH	J24189028		1-	B	b5
R 1202	CHIP RES.	470	1/16W	5%	RMC1/16S 471JTH	J24189021		1-	A	A1
R 1204	CHIP RES.	10k	1/16W	5%	RMC1/16S 103JTH	J24189037		1-	A	B4
R 1205	CHIP RES.	0	1/16W	5%	RMC1/16S JPTH	J24189070		1-	B	b5
R 1206	CHIP RES.	22	1/16W	5%	RMC1/16S 220JTH	J24189005		1-	B	b3
R 1207	CHIP RES.	33k	1/16W	5%	RMC1/16S 333JTH	J24189043		1-	A	C4
R 1208	CHIP RES.	33k	1/16W	5%	RMC1/16S 333JTH	J24189043		1-	A	C4
R 1210	CHIP RES.	4.7k	1/16W	5%	RMC1/16S 472JTH	J24189033		1-	A	C4
R 1211	CHIP RES.	3.3k	1/16W	5%	RMC1/16S 332JTH	J24189031		1-	B	b3
R 1213	CHIP RES.	22k	1/16W	5%	RMC1/16S 223JTH	J24189041		1-	A	C4
R 1214	CHIP RES.	470k	1/16W	5%	RMC1/16S 474JTH	J24189057		1-	B	c3
R 1219	CHIP RES.	2.2k	1/16W	5%	RMC1/16S 222JTH	J24189029		1-	B	b3
R 1220	CHIP RES.	1.5k	1/16W	5%	RMC1/16S 152JTH	J24189027		1-	B	c3
R 1223	CHIP RES.	3.3k	1/16W	5%	RMC1/16S 332JTH	J24189031		1-	B	b3
R 1224	CHIP RES.	22k	1/16W	5%	RMC1/16S 223JTH	J24189041		1-	B	c3
R 1226	CHIP RES.	22	1/16W	5%	RMC1/16S 220JTH	J24189005		1-	B	b5
R 1228	CHIP RES.	56k	1/16W	5%	RMC1/16S 563JTH	J24189046		1-	A	C4
R 1229	CHIP RES.	47k	1/16W	5%	RMC1/16S 473JTH	J24189045		1-	A	C4
R 1230	CHIP RES.	6.8k	1/16W	5%	RMC1/16S 682JTH	J24189035		1-	B	b3
R 1231	CHIP RES.	100k	1/16W	0.5%	MCR01MZPD1003	J24189386		1-	A	B3
R 1233	CHIP RES.	560	1/16W	0.5%	MCR01MZPD5600	J24189359		1-5	A	B3
R 1233	CHIP RES.	560	1/16W	0.5%	MCR01MZPD5600	J24189359	EU	7-	A	B3
R 1233	CHIP RES.	560	1/16W	0.5%	MCR01MZPD5600	J24189359	EXP VER. A	8-	A	B3
R 1233	CHIP RES.	560	1/16W	0.5%	MCR01MZPD5600	J24189359	VERSION D	6-	A	B3
R 1233	CHIP RES.	560	1/16W	0.5%	MCR01MZPD5600	J24189359	VTX VER. A	8-	A	B3
R 1234	CHIP RES.	100k	1/16W	0.5%	MCR01MZPD1003	J24189386		1-	A	B3
R 1235	CHIP RES.	1M	1/16W	5%	RMC1/16S 105JTH	J24189061		1-6	B	c4
R 1235	CHIP RES.	220k	1/16W	5%	RMC1/16S 224JTH	J24189053		7-	B	c4
R 1236	CHIP RES.	22	1/16W	5%	RMC1/16S 220JTH	J24189005		1-	B	b5
R 1237	CHIP RES.	1k	1/16W	5%	RMC1/16S 102JTH	J24189025		1-	B	c5
R 1238	CHIP RES.	82k	1/16W	5%	RMC1/16S 823JTH	J24189048		1-	A	B4
R 1239	CHIP RES.	100k	1/16W	5%	RMC1/16S 104JTH	J24189049		1-	A	C4
R 1240	CHIP RES.	0	1/16W	5%	RMC1/16S JPTH	J24189070		1-	B	b4
R 1241	CHIP RES.	100	1/16W	5%	RMC1/16S 101JTH	J24189013		1-	B	b5
R 1242	CHIP RES.	1k	1/16W	5%	RMC1/16S 102JTH	J24189025		1-	B	c5
R 1243	CHIP RES.	470k	1/16W	0.5%	MCR01MZPD4703	J24189332		1-5	A	B3
R 1243	CHIP RES.	470k	1/16W	0.5%	MCR01MZPD4703	J24189332	EU VER. A	7-	A	B3
R 1243	CHIP RES.	470k	1/16W	0.5%	MCR01MZPD4703	J24189332	EXP VER. A	8-	A	B3
R 1243	CHIP RES.	470k	1/16W	0.5%	MCR01MZPD4703	J24189332	VERSION D	6-	A	B3
R 1243	CHIP RES.	470k	1/16W	0.5%	MCR01MZPD4703	J24189332	VTX VER. A	8-	A	B3
R 1244	CHIP RES.	4.7k	1/16W	5%	RMC1/16S 472JTH	J24189033		1-	B	c4
R 1245	CHIP RES.	180k	1/16W	5%	RMC1/16S 184JTH	J24189052		1-	A	B4
R 1246	CHIP RES.	5.6k	1/16W	5%	RMC1/16S 562JTH	J24189034		1-	B	b4
R 1247	CHIP RES.	22k	1/16W	0.5%	MCR01MZPD2202	J24189378		1-	A	B3
R 1248	CHIP RES.	100k	1/16W	5%	RMC1/16S 104JTH	J24189049		1-	A	B3
R 1249	CHIP RES.	0	1/16W	5%	RMC1/16S JPTH	J24189070		1-	A	B3
R 1251	CHIP RES.	10k	1/16W	0.5%	MCR01MZPD1002	J24189374		1-5	A	B3
R 1251	CHIP RES.	10k	1/16W	0.5%	MCR01MZPD1002	J24189374	VERSION D	6	A	B3
R 1251	CHIP RES.	10k	1/16W	0.5%	MCR01MZPD1002	J24189374		7-	A	B3
R 1252	CHIP RES.	100k	1/16W	5%	RMC1/16S 104JTH	J24189049		1-	A	B3
R 1253	CHIP RES.	18k	1/16W	5%	RMC1/16S 183JTH	J24189040		1-	A	B3
R 1255	CHIP RES.	100k	1/16W	5%	RMC1/16S 104JTH	J24189049		1-	A	B3
R 1256	CHIP RES.	27k	1/16W	5%	RMC1/16S 273JTH	J24189042		1-	A	B3
R 1257	CHIP RES.	33k	1/16W	5%	RMC1/16S 333JTH	J24189043		1-	A	B3
R 1258	CHIP RES.	82k	1/16W	5%	RMC1/16S 823JTH	J24189048		1-	A	B4
R 1259	CHIP RES.	10	1/16W	5%	RMC1/16S 100JTH	J24189001		1-	B	b4
R 1260	CHIP RES.	18k	1/16W	5%	RMC1/16S 183JTH	J24189040		1-	A	B3
R 1261	CHIP RES.	33k	1/16W	5%	RMC1/16S 333JTH	J24189043		1-	A	B3
R 1262	CHIP RES.	68k	1/16W	5%	RMC1/16S 683JTH	J24189047		1-	A	B3
R 1263	CHIP RES.	100k	1/16W	5%	RMC1/16S 104JTH	J24189049		1-	A	B4
R 1273	CHIP RES.	22k	1/16W	5%	RMC1/16S 223JTH	J24189041		1-	A	C3
R 1274	CHIP RES.	100k	1/16W	5%	RMC1/16S 104JTH	J24189049		1-	B	b2
R 1275	CHIP RES.	100k	1/16W	5%	RMC1/16S 104JTH	J24189049		1-	B	b3
R 1276	CHIP RES.	10k	1/16W	5%	RMC1/16S 103JTH	J24189037		1-	A	B5

Parts List

REF.	DESCRIPTION	VALUE	V/W	TOL.	MFR'S DESIG	VXSTD P/N	VERS.	LOT.	SIDE	LAY ADR
R 1277	CHIP RES.	10k	1/16W	5%	RMC1/16S 103JTH	J24189037		1-	A	B5
R 1278	CHIP RES.	10k	1/16W	5%	RMC1/16S 103JTH	J24189037		1-	A	B5
R 1279	CHIP RES.	10k	1/16W	5%	RMC1/16S 103JTH	J24189037		1-	A	B5
R 1280	CHIP RES.	10k	1/16W	5%	RMC1/16S 103JTH	J24189037		1-	A	B5
R 1281	CHIP RES.	10k	1/16W	5%	RMC1/16S 103JTH	J24189037		1-	A	B5
R 1282	CHIP RES.	10k	1/16W	5%	RMC1/16S 103JTH	J24189037		1-	A	B5
R 1283	CHIP RES.	22k	1/16W	5%	RMC1/16S 223JTH	J24189041		1-	A	B5
R 1284	CHIP RES.	18	1/8W	5%	RMC1/8T 180J	J24215180		1-	B	a2
R 1285	CHIP RES.	0	1/16W	5%	RMC1/16S JPTH	J24189070		1-6	B	a2
R 1285	CHIP RES.	0	1/16W	5%	RMC1/16S JPTH	J24189070	VERSION D	7-	B	a2
R 1287	CHIP RES.	100k	1/16W	5%	RMC1/16S 104JTH	J24189049		1-	B	c5
R 1294	CHIP RES.	3.3k	1/16W	5%	RMC1/16S 332JTH	J24189031		1-	B	a3
R 1295	CHIP RES.	22k	1/16W	5%	RMC1/16S 223JTH	J24189041		1-	A	B3
R 1296	CHIP RES.	100k	1/16W	5%	RMC1/16S 104JTH	J24189049		1-	A	C4
R 1297	CHIP RES.	0	1/16W	5%	RMC1/16S JPTH	J24189070		1-	B	b2
R 1298	CHIP RES.	0	1/16W	5%	RMC1/16S JPTH	J24189070		1-5	B	b2
R 1298	CHIP RES.	0	1/16W	5%	RMC1/16S JPTH	J24189070	VERSION D	6-	B	b2
R 1299	CHIP RES.	0	1/16W	5%	RMC1/16S JPTH	J24189070		1-	B	b2
R 1300	CHIP RES.	0	1/16W	5%	RMC1/16S JPTH	J24189070		1-	B	b3
R 1301	CHIP RES.	100k	1/16W	5%	RMC1/16S 104JTH	J24189049		1-	A	A4
R 1302	CHIP RES.	2.2k	1/16W	5%	RMC1/16S 222JTH	J24189029		1-	B	a5
R 1303	CHIP RES.	0	1/16W	5%	RMC1/16S JPTH	J24189070		1-	A	C3
R 1304	CHIP RES.	10k	1/16W	5%	RMC1/16S 103JTH	J24189037		1-	A	A3
R 1306	CHIP RES.	18	1/8W	5%	RMC1/8T 180J	J24215180		1-	B	a2
R 1307	CHIP RES.	10k	1/16W	5%	RMC1/16S 103JTH	J24189037		1-	B	c5
R 1308	CHIP RES.	0	1/16W	5%	RMC1/16S JPTH	J24189070		6-	A	C1
RB1001	BLOCK RES.				CN1J4TTD223J	J42900050		1-	A	B5
RB1002	BLOCK RES.				CN1J4TTD223J	J42900050		1-	A	B5
S 1001	TACT SWITCH				SKHLLD	N5090066		1-	B	c1
S 1002	TACT SWITCH				SKRTLAE010	N5090130		1-	B	c2
S 1003	TACT SWITCH				SKRTLAE010	N5090130		1-	B	c3
S 1004	ROTARY SWITCH				EC10SP16-85A0	Q9000764		1-	B	b1
TH1001	THERMISTOR				TH05 4B473FR	G9090150		1-	A	B4
VR1001	POT.				RK0971111 20KA/SW	J60800256		1-	B	a1
X 1001	XTAL U3B	3.6864MHz			3.686400MHz (11p)	H0103307		1-	B	c4
X 1002	TCXO	16.8MHz			HKE3149A 16.8MHZ	H9501060		1-	B	b4
XF1001	XTAL FILTER				TF4-67EA1 67.65MHZ	H1102399		1-6	B	b3
XF1001	XTAL FILTER				HF-734A 67.65MHZ-L2YM	H1102456	EU	7-	B	b3
XF1001	XTAL FILTER				TF4-67EA1 67.65MHZ	H1102399	VTX/EXP	7-	B	b3
	HOLDER RUBBER				(MIC)	RA0110200		1-		
	LEAF SPRING					RA1085200	EU	7-		
	SHIELD CASE COVER					RA1124300	EU	7-		



Copyright 2010
VERTEX STANDARD CO., LTD.
All rights reserved

No portion of this manual
may be reproduced without
the permission of
VERTEX STANDARD CO., LTD.