

144/430 MHz 50 W Dual-Band Transceiver

FTM-100DR/DE

EH048M90D

©2019 YAESU MUSEN CO., LTD.

Introduction

This manual provides the technical information necessary for servicing the FTM-100DR/DE 144/430 MHz 50 W Dual Band Transceiver.

Servicing this equipment requires expertise in handling surface-mount chip components. Attempts by non-qualified persons to service this equipment may result in permanent damage not covered by the warranty, and may be illegal in some countries.

While we believe the information in this manual to be correct, YAESU assumes no liability for damage that may occur as a result of typographical or other errors that may be present. Your cooperation in pointing out any inconsistencies in the technical information would be appreciated.

Contents

- Specifications
- Exploded View
- Block Diagram
- Alignment
- Board Unit (Schematics, Layouts & Parts)
 - MAIN Unit
 - PANEL Unit
 - PANEL SUB Unit
 - DSP Unit

Important Note

This transceiver was assembled using Pb (lead) free solder, based on the RoHS specification.

Only lead-free solder (Alloy Composition: Sn-3.0Ag-0.5Cu) should be used for repairs performed on this apparatus. The solder stated above utilizes the alloy composition required for compliance with the lead-free specification, and any solder with the above alloy composition may be used.

General

Frequency Range:	TX 144 - 146 MHz or 144 - 148 MHz 430 - 440 MHz or 430 - 450 MHz RX 108 - 137 MHz (Air Band) 137 - 174 MHz (144 MHz HAM) 174 - 400 MHz (GEN1) 400 - 480 MHz (430 MHz HAM) 480 - 999.99 MHz (GEN2) (Cellular Blocked (USA only))
Channel Steps:	5, 6.25, 8.33, 10, 12.5, 15, 20, 25, 50, 100 kHz (8.33 kHz: only for Air Band)
Frequency Stability:	±2.5 ppm (-4 °F to +140 °F [-20 °C to +60 °C])
Emission Type:	F1D, F2D, F3E, F7W
Supply Voltage:	Nominal 13.8 V DC, negative ground
Current Consumption:	0.5 A (receive) 11 A (50 W TX, 144 MHz) 12 A (50 W TX, 430 MHz)
Operating Temperature:	-4 °F to +140 °F (-20 °C to +60 °C)
Case Size (W x H x D):	Radio unit: 5.5" (W) × 1.8" (H) × 6.5" (D) (140 × 45 × 164 mm) w/o fan Front panel: 5.5" (W) × 1.8" (H) × 1.2" (D) (140 × 45 × 29 mm)
Weight (approx.):	2.43 lbs (1.1 kg) with radio unit, controller, control cable

Transmitter

RF Power Output:	50 / 20 / 5 W
Modulation Type:	F1D, F2D, F3E : Variable Reactance modulation F7W: 4 FSK (C4FM)
Spurious Emission:	At least 60 dB below

Receiver

Circuit Type:	Double-Conversion Super heterodyne
Intermediate Frequencies:	1 st: 47.25 MHz, 2 nd: 450 kHz
Sensitivity:	108 - 137 MHz (AM) 0.8 μ V typ for 10 dB SN 137 - 140 MHz (FM) 0.2 μ V for 12 dB SINAD 140 - 150MHz (FM) 0.2 μ V for 12 dB SINAD 150 - 174 MHz (FM) 0.25 μ V for 12 dB SINAD 174 - 222 MHz (FM) 0.3 μ V typ for 12 dB SINAD 222 - 300 MHz (FM) 0.25 μ V typ for 12 dB SINAD 300 - 336 MHz (AM) 0.8 μ V typ for 10 dB SINAD 336 - 420 MHz (FM) 0.25 μ V for 12 dB SINAD 420 - 470 MHz (FM) 0.2 μ V typ for 12 dB SINAD 470 - 520 MHz (FM) 0.2 μ V for 12 dB SINAD 800 - 900 MHz (FM) 0.4 μ V typ for 12 dB SINAD 900 - 999.99 MHz (FM) 0.8 μ V typ for 12 dB SINAD Cellular blocked (USA only)
	Digital mode
	140 - 150 MHz (Digital) 0.19 μ V typ for BER 1%
	420 - 470 MHz (Digital) 0.19 μ V typ for BER 1%
Selectivity:	NFM, AM 12 kHz/30 kHz (-6 dB/-60 dB)
AF Output:	3 W (8 Ω , THD10%, 13.8 V) internal speaker 8 W (4 Ω , THD10%, 13.8 V) Optional MLS-200-M10
AF output impedance:	4 - 16 Ω
Strength of secondary radio waves:	4 nW and below

Performance specifications are nominal, unless otherwise indicated, and are subject to change without notice. Measured in accordance with TIA/EIA-603.

Exploded View & Miscellaneous Parts

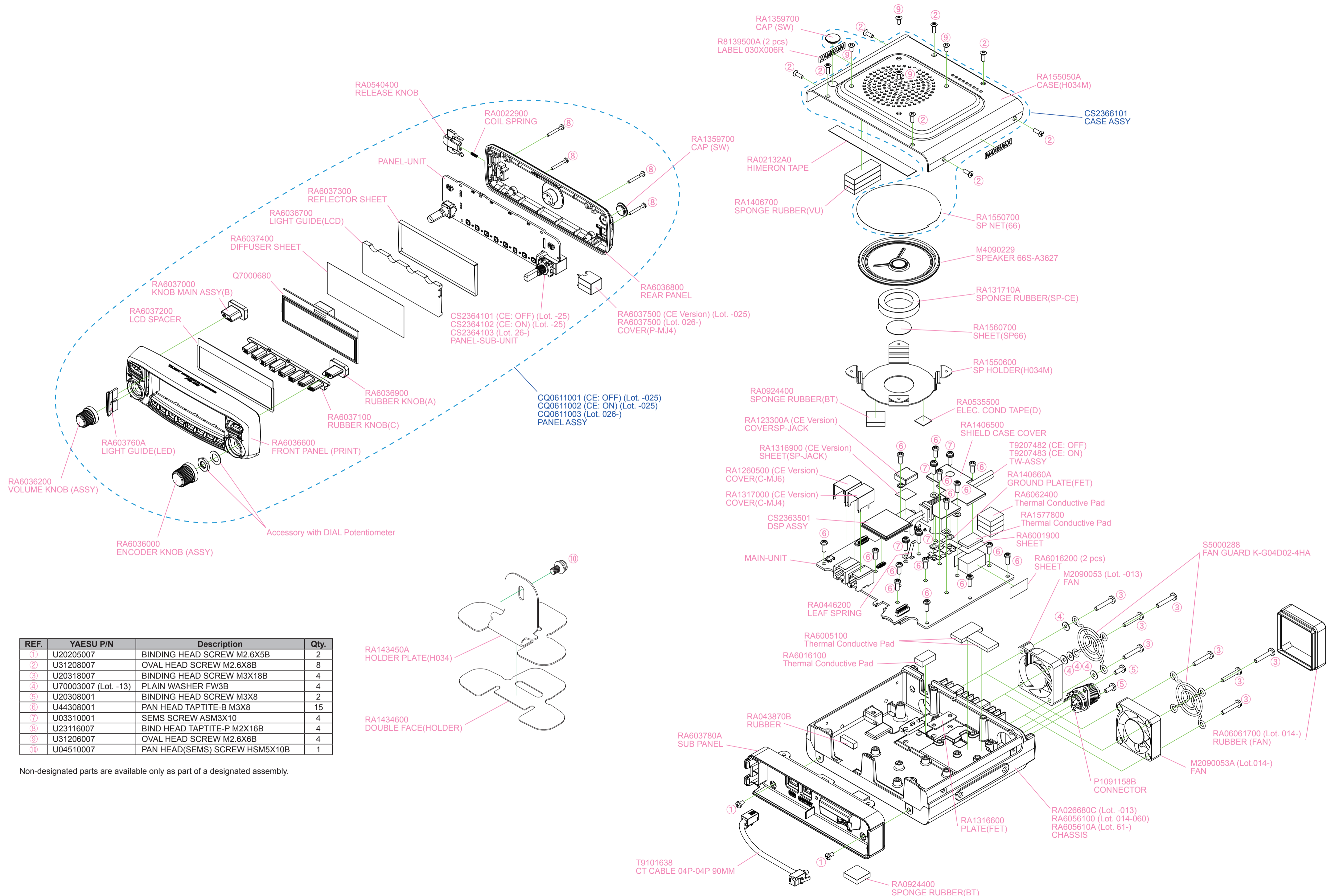

REF.	YAESU P/N	Description	Qty.
①	U20205007	BINDING HEAD SCREW M2.6X5B	2
②	U31208007	OVAL HEAD SCREW M2.6X8B	8
③	U20318007	BINDING HEAD SCREW M3X18B	4
④	U70003007 (Lot. -13)	PLAIN WASHER FW3B	4
⑤	U20308001	BINDING HEAD SCREW M3X8	2
⑥	U44308001	PAN HEAD TAPTITE-B M3X8	15
⑦	U03310001	SEMS SCREW ASM3X10	4
⑧	U23116007	BIND HEAD TAPTITE-P M2X16B	4
⑨	U31206007	OVAL HEAD SCREW M2.6X6B	4
⑩	U04510007	PAN HEAD(SEMS) SCREW HSM5X10B	1

Non-designated parts are available only as part of a designated assembly.

EXPLODED VIEW-1

Introduction and Precautions

The FTM-100DR/FTM-100DE has been carefully aligned at the factory for performance across the specified amateur bands. Realignment should therefore not be necessary except in the event of a component failure. All component replacement and service should be performed only by an authorized YAESU representative, or the warranty policy may be voided.

The following procedures cover the sometimes critical and tedious adjustments that are not normally required once the transceiver has left the factory. However, if damage occurs and some parts are replaced, realignment may be required. If a sudden problem occurs during normal operation, it is likely due to component failure; realignment should not be done until after the faulty component has been replaced.

We recommend that servicing be performed only by authorized YAESU service technicians, who are experienced with the circuitry and fully equipped for repair and alignment. Therefore, if a fault is suspected, contact the dealer from whom the transceiver was purchased for instructions regarding repair. Authorized YAESU service technicians realign all circuits and make complete performance checks to ensure compliance with factory specifications after replacing any faulty components.

Those who do undertake any of the following alignments are cautioned to proceed at their own risk. Problems caused by unauthorized attempts at realignment are not covered by the warranty policy. Also, YAESU must reserve the right to change circuits and alignment procedures in the interest of improved performance, without notifying owners.

Under no circumstances should any alignment be attempted unless the normal function and operation of the transceiver are clearly understood, the cause of the malfunction has been clearly pinpointed and any faulty components replaced, and the need for realignment determined to be absolutely necessary.

Required Test Equipment

- RF Signal Generator with calibrated output level at 1 GHz
- Deviation Meter (linear detector)
- In-line Wattmeter with 5% accuracy at 1 GHz
- 50-ohm, 100-W RF Dummy Load
- 8-ohm AF Dummy Load
- Regulated DC Power Supply adjustable from 11.5 to 16 V DC, 15 A
- Frequency Counter: 0.2-ppm accuracy at 1 GHz
- AF Signal Generator
- AC Voltmeter
- DC Voltmeter: high impedance
- VHF/UHF Sampling Coupler
- SINAD Meter

Important Notice

Do not adjust the alignment menus that are not mentioned in this manual.

Alignment

Alignment Preparation & Precautions

A 100-W RF dummy load and in-line wattmeter must be connected to the main antenna jack in all procedures that call for transmission; alignment is not possible with an antenna. After completing one step, read the next step to see if the same test equipment is required. If not, remove the test equipment (except dummy load and wattmeter, if connected) before proceeding. Correct alignment requires the transceiver and test equipment be maintained at a constant ambient temperature between 68 ~ 86 °F (20 ~ 30 °C). When the transceiver is brought into the shop from hot or cold air, it should be allowed some time to come to room temperature before alignment. Whenever possible, alignments should be made with oscillator shields and circuit boards firmly affixed in place. Also, the test equipment must be thoroughly warmed up before beginning.

Note: Signal levels in dB referred to in the alignment procedure are based on 0 dB μ =0.5 μ V (closed circuit).

Test Setup

Set up the test equipment as shown below for transceiver alignment. Maintain the supply voltage at 13.8V DC for all steps.

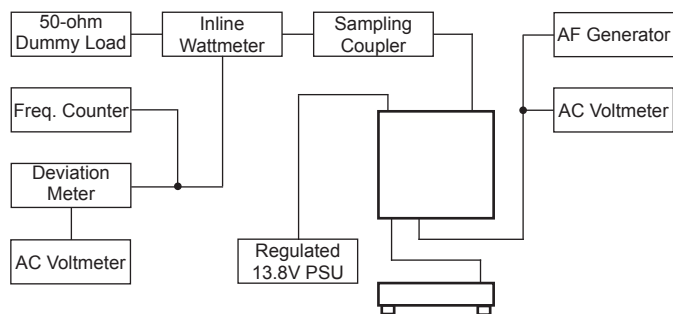

Internal System Alignment Routine

This uses a programmed routine in the transceiver which simplifies many previously complex discrete component settings and adjustments with digitally-controlled settings via Microphone buttons.

To enter the Alignment mode:

1. Press and hold in the [**A/B(DW)**] and [**GM**] keys while turning the transceiver on.
2. Press the [**POWER(LOCK)**] key. "LOCK" will appear in the display.
3. Press the keys of the Microphone in the following sequence.

[0] \Rightarrow [4] \Rightarrow [8] \Rightarrow [0] \Rightarrow [4] \Rightarrow [8]

4. Press the [**POWER(LOCK)**] key. "UNLOCK" will appear in the display.
5. The transceiver is now in the "Alignment mode".

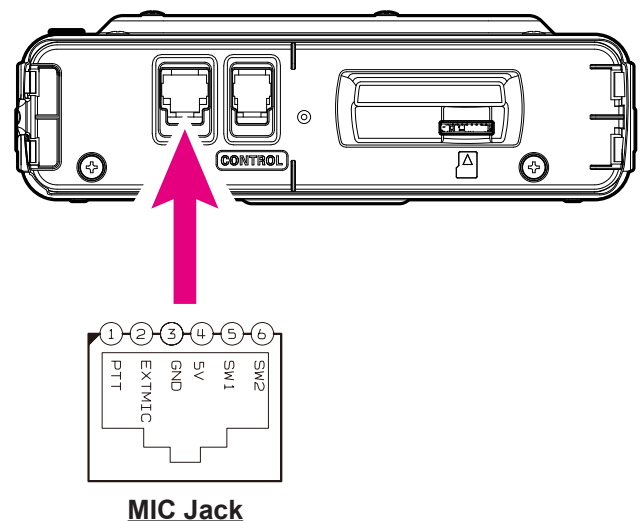

VCO VCV Adjustment

Connect the DC voltmeter to **TP1503**. Referring to the table below, turn the transceiver to frequency listed. Confirm that the correct voltage is present, or adjust the listed setting for the required voltage.

Tune to:	TX/RX	for
440.05 MHz	RX	2.75 ± 0.25 V
440.05 MHz	TX	2.15 ± 0.25 V
146.05 MHz	RX	1.15 ± 0.30 V
146.05 MHz	TX	1.75 ± 0.30 V
130.00 MHz	RX	0.05 - 0.60 V
174.00 MHz	RX	0.05 - 0.70 V
299.99 MHz	RX	4.5 - 6.1 V
549.95 MHz	RX	3.5 - 5.0 V
550.00 MHz	RX	0.20 - 0.60 V

DC Voltmeter

1. Set the power supply voltage to 13.8 V.
2. Press the **[P1]** key of the Microphone to set the alignment menu Item to "A BAT".
3. Press the **[P3]** key of the Microphone, to save the new setting.

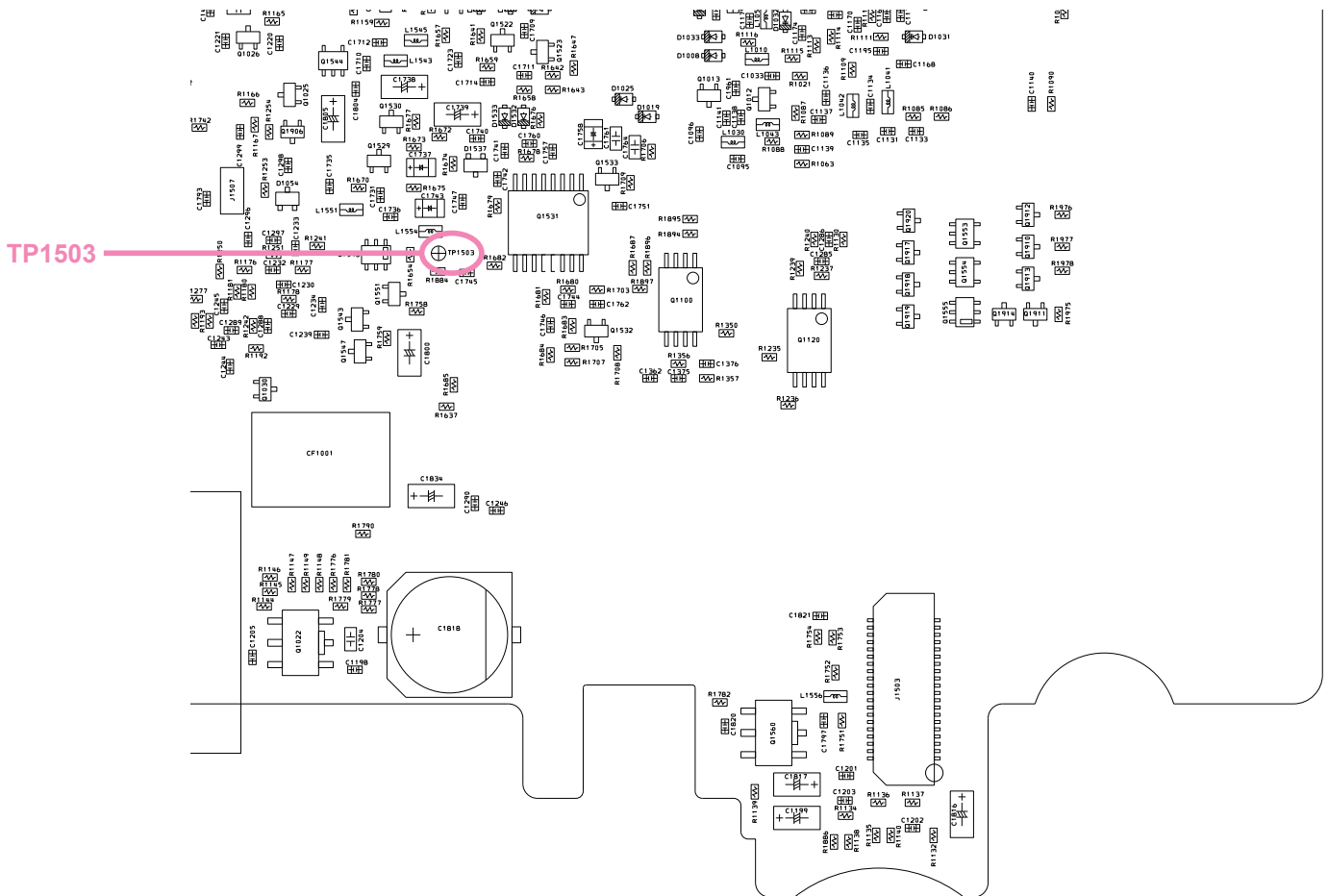

TX Power Adjustment

1. Press the **[P1]** key of the Microphone to set the alignment menu Item to "**2 PWR**".
2. Set the transceiver frequency to 440.050 MHz.
3. Press the **[TXPO]** key to select "**LOW**".
4. Press the PTT switch to activate the transmitter, adjust the **DIAL** knob so that RF Power Meter reading is 5.3 W (± 0.5 W).
5. Press the **[P2]** key of the Microphone to set the alignment menu Item to "**2 DRV**".
6. Adjust the **DIAL** knob (Band B) to set the DRV to "**9AH**".
7. Press the **[P2]** key of the Microphone to set the alignment menu Item to "**2 PWR**".
8. Press the **[TXPO]** key to select "**MID**".
9. Press the PTT switch to activate the transmitter, adjust the **DIAL** knob so that RF Power Meter reading is 20 W (± 0.5 W).
10. Press the **[P2]** key of the Microphone to set the alignment menu Item to "**2 DRV**".
11. Adjust the **DIAL** knob to set the DRV to "**B0H**".
12. Press the **[P2]** key of the Microphone to set the alignment menu Item to "**2 PWR**".
13. Press the **[TXPO]** key to select "**HIGH**".
14. Press the PTT switch to activate the transmitter, adjust the **DIAL** knob so that RF Power Meter reading is 50 W (± 0.5 W).
15. Press the **[P2]** key of the Microphone to set the alignment menu Item to "**2 DRV**".
16. Adjust the **DIAL** knob to set the DRV to "**D0H**".
17. Press the **[P2]** key of the Microphone to set the alignment menu Item to "**2 PWR**".
18. Set the transceiver frequency to 146.050 MHz.
19. Press the **[TXPO]** key to select "**LOW**".
20. Press the PTT switch to activate the transmitter, adjust the **DIAL** knob so that RF Power Meter reading is 5 W (± 0.5 W).
21. Press the **[P2]** key of the Microphone to set the alignment menu Item to "**2 DRV**".
22. Adjust the **DIAL** knob to set the DRV to "**CFH**".
23. Press the **[P2]** key of the Microphone to set the alignment menu Item to "**2 PWR**".
24. Press the **[TXPO]** key to select "**MID**".
25. Press the PTT switch to activate the transmitter, adjust the **DIAL** knob so that RF Power Meter reading is 20 W (± 0.5 W).
26. Press the **[P2]** key of the Microphone to set the alignment menu Item to "**2 DRV**".
27. Adjust the **DIAL** knob to set the DRV to "**DAH**".
28. Press the **[P2]** key of the Microphone to set the alignment menu Item to "**2 PWR**".
29. Press the **[TXPO]** key to select "**HIGH**".
30. Press the PTT switch to activate the transmitter, adjust the **DIAL** knob so that RF Power Meter reading is 48 W (± 0.5 W).
31. Press the **[P2]** key of the Microphone to set the alignment menu Item to "**2 DRV**".
32. Adjust the **DIAL** knob to set the DRV to "**EFH**".
33. Press the **[P2]** key of the Microphone to set the alignment menu Item to "**2 PWR**".

PLL Reference Frequency Adjustment

1. Press the **[P1]** key of the Microphone to set the alignment menu Item to "0 REF".
2. Set the transceiver frequency to 435.050 MHz.
3. Press the **[TXPO]** key to select "LOW".
4. Press the **PTT** switch to activate the transmitter, adjust the **DIAL** knob, if necessary, so the counter frequency is within 100 Hz of 435.050MHz.

RF Front-end Tuning

1. Connect the DC voltmeter to **TP1001** on the MAIN unit, then inject a 439.050 MHz signal at a level of +10 dB μ V (with 1kHz modulation \pm 3.5 kHz (USA Version: \pm 3 kHz) deviation) from the RF signal generator.
2. Set the transceiver frequency to 439.050 MHz.
3. Press the **[P1]** key of the Microphone to set the alignment menu Item to "1 TUN".
4. Adjust the **DIAL** knob for maximum deflection on the DC Voltmeter and then turn the dial in the opposite direction until the meter deflection drops slightly lower than maximum.
5. Set the transceiver and RF signal generator frequency to 145.050 MHz.
6. Adjust the **DIAL** knob for maximum deflection on the DC Voltmeter and then turn the dial in the opposite direction until the meter deflection drops slightly lower than maximum.

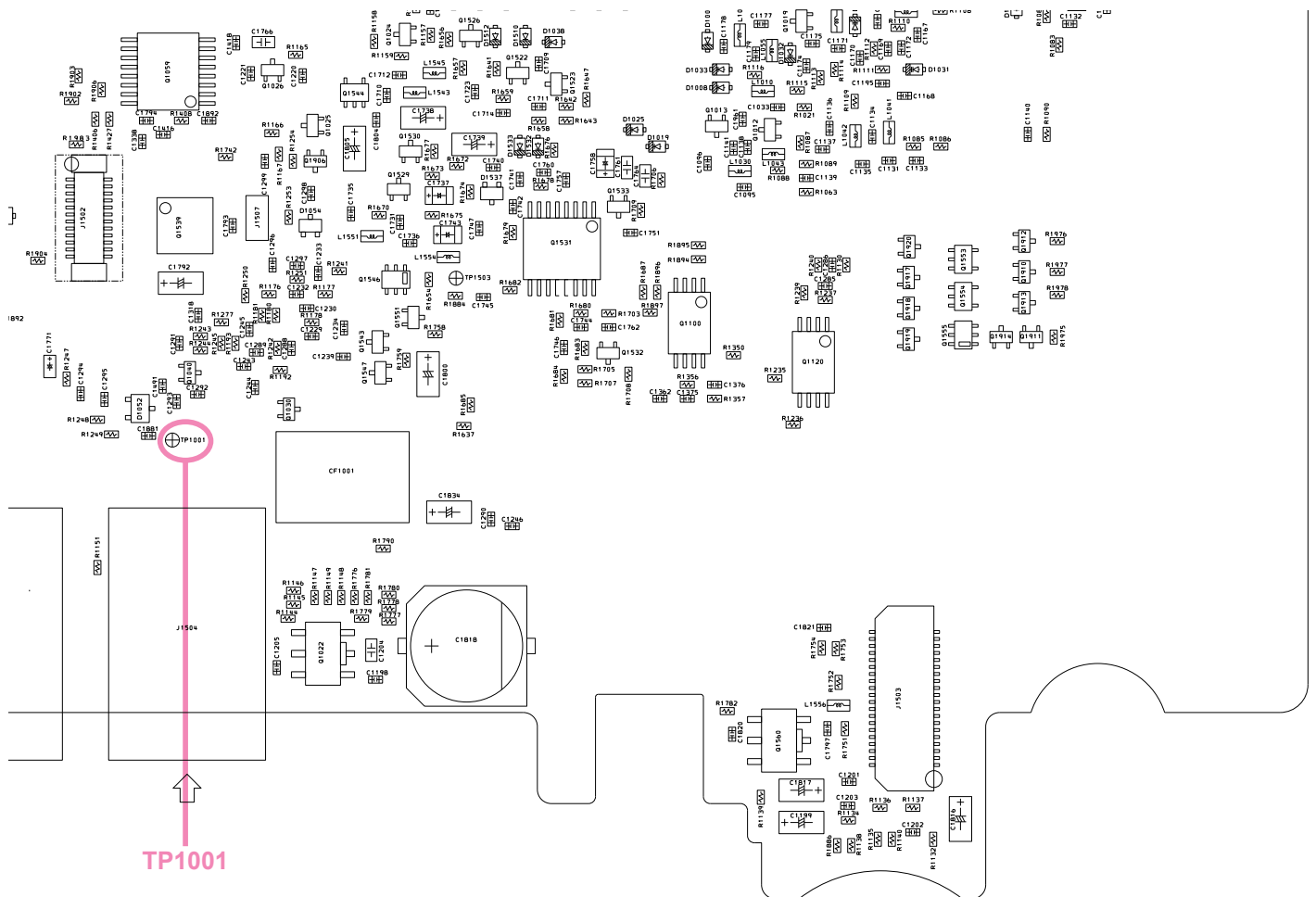

Squelch Threshold Level

1. Set the RF signal generator to 440.050 MHz. Set the generator for ± 3.5 kHz (USA Version: ± 3 kHz) deviation of a 1 kHz modulation tone, and set the RF output level from the signal generator to -13.5 dB μ V.
2. Set the transceiver frequency to 440.050 MHz.
3. Press the [**D(X)**] key to select "FM".
4. Press the [**P1**] key of the Microphone to set the alignment menu Item to "**9 SQL**".
5. Press the [**P4**] key to save the new setting.
6. Increase the output level of the signal generator up to -4 dB μ V.
7. Press the [**P3**] key to save the new setting.
8. Set the transceiver and RF signal generator frequency to 146.050 MHz.
9. Increase the output level of the signal generator up to -13.5 dB μ V.
10. Press the [**P4**] key to save the new setting.
11. Increase the output level of the signal generator up to -4 dB μ V.
12. Press the [**P3**] key to save the new setting.

S-Meter Calibration

1. Set the RF signal generator to 440.050 MHz. Set the generator for ± 3.5 kHz (USA Version: ± 3 kHz) deviation of a 1 kHz modulation tone, and set the RF output level from the signal generator to -5 dB μ V.
2. Set the transceiver frequency to 440.050 MHz.
3. Press the [**D(X)**] key to select "FM".
4. Press the [**P1**] key of the Microphone to set the alignment menu Item to "**8 SM**".
5. Press the [**P4**] key to save the new setting.
6. Increase the output level of the signal generator up to $+23$ dB μ V.
7. Press the [**P3**] key to save the new setting.
8. Set the transceiver and RF signal generator frequency to 146.050 MHz.
9. Increase the output level of the signal generator up to -5 dB μ V.
10. Press the [**P4**] key to save the new setting.
11. Increase the output level of the signal generator up to $+23$ dB μ V.
12. Press the [**P3**] key to save the new setting.

TX Deviation

1. Inject a 1 kHz, 80 mV signal from the Audio Generator.
2. Set the transceiver frequency to 440.050 MHz.
3. Press the [**TXPO**] key to select "**LOW**".
4. Press the [**P1**] key of the Microphone to set the alignment menu Item to "**3 DEV**".
5. Press the **PTT** switch to activate the transmitter, adjust the **DIAL** knob so that the Deviation Meter reading is 4.5 kHz (± 0.2 kHz) (USA Version: 4.2 kHz (± 0.2 kHz)).
6. Set the transceiver frequency to 146.050 MHz.
7. Press the [**TXPO**] key to select "**LOW**".
8. Press the **PTT** switch to activate the transmitter, adjust the **DIAL** knob so that the Deviation Meter reading is 4.5 kHz (± 0.2 kHz) (USA Version: 4.2 kHz (± 0.2 kHz)).

Digital TX Deviation

1. Inject a 1 kHz, 80 mV signal from the Audio Generator.
2. Set the transceiver frequency to 440.050 MHz.
3. Press the [**TXPO**] key to select "**LOW**".
4. Press the [**P1**] key of the Microphone to set the alignment menu Item to "**4 MOD**".
5. Press the [**P2**] key of the Microphone to set the alignment menu Item to "**4 MIX**".
6. Press the **PTT** switch to activate the transmitter, adjust the **DIAL** knob so that the Deviation Meter reading is 4.5 kHz (± 0.2 kHz).
7. Set the transceiver frequency to 146.050 MHz.
8. Press the [**TXPO**] key to select "**LOW**".
9. Press the **PTT** switch to activate the transmitter, adjust the **DIAL** knob so that the Deviation Meter reading is 4.5 kHz (± 0.2 kHz).

DCS TX Deviation

1. Set the transceiver frequency to 440.050 MHz.
2. Press the [TXPO] key to select "LOW".
3. Press and hold the [TXPO] key for 1 second to select "DCS".
4. Press the [P1] key of the Microphone to set the alignment menu Item to "5 DCS".
5. Press the **PTT** switch to activate the transmitter, adjust the **DIAL** knob so that the Deviation Meter reading is 0.60 kHz ~ 0.80 kHz.
6. Set the transceiver frequency to 146.050 MHz.
7. Press the [TXPO] key to select "LOW".
8. Press and hold the [TXPO] key for 1 second to select "DCS".
9. Press the **PTT** switch to activate the transmitter, adjust the **DIAL** knob so that the Deviation Meter reading is 0.60 kHz ~ 0.80 kHz.

CTCSS TX Deviation

1. Set the transceiver frequency to 440.050 MHz.
2. Press the [TXPO] key to select "LOW".
3. Press and hold the [TXPO] key for 1 second to select "TSQ".
4. Press the [P1] key of the Microphone to set the alignment menu Item to "6 CTC".
5. Press the **PTT** switch to activate the transmitter, adjust the **DIAL** knob so that the Deviation Meter reading is 0.65 kHz ~ 0.75 kHz.
6. Set the transceiver frequency to 146.050 MHz.
7. Press the [TXPO] key to select "LOW".
8. Press and hold the [TXPO] key for 1 second to select "TSQ".
9. Press the **PTT** switch to activate the transmitter, adjust the **DIAL** knob so that the Deviation Meter reading is 0.65 kHz ~ 0.75 kHz.

Center Meter Calibration

1. Set the RF signal generator to 440.050 MHz. Set the generator for ± 3.5 kHz (USA Version: ± 3 kHz) deviation of a 1 kHz modulation tone, and set the RF output level from the signal generator to +10 dB μ V.
2. Set the transceiver frequency to 440.050 MHz.
3. Press the [D(X)] key to select "FM".
4. Press the [P1] key of the Microphone to set the alignment menu Item to "7 CTR".
5. Press the [P3] key to save the new setting.

To close the alignment mode, just turn the power off by pressing and holding the [POWER(LOCK)] switch for two seconds. The next time the transceiver is turned on, normal operation will resume.

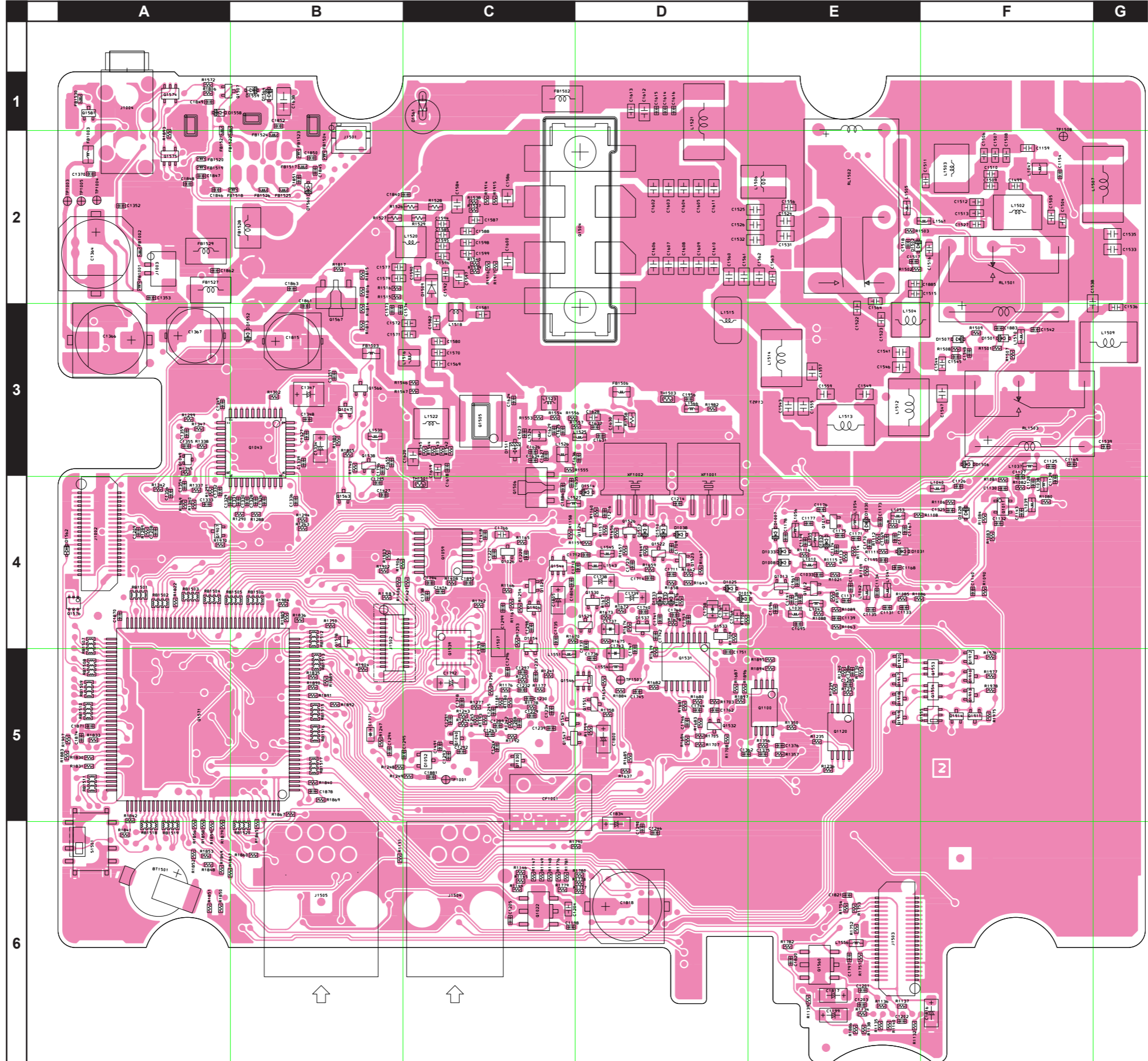

MAIN-2

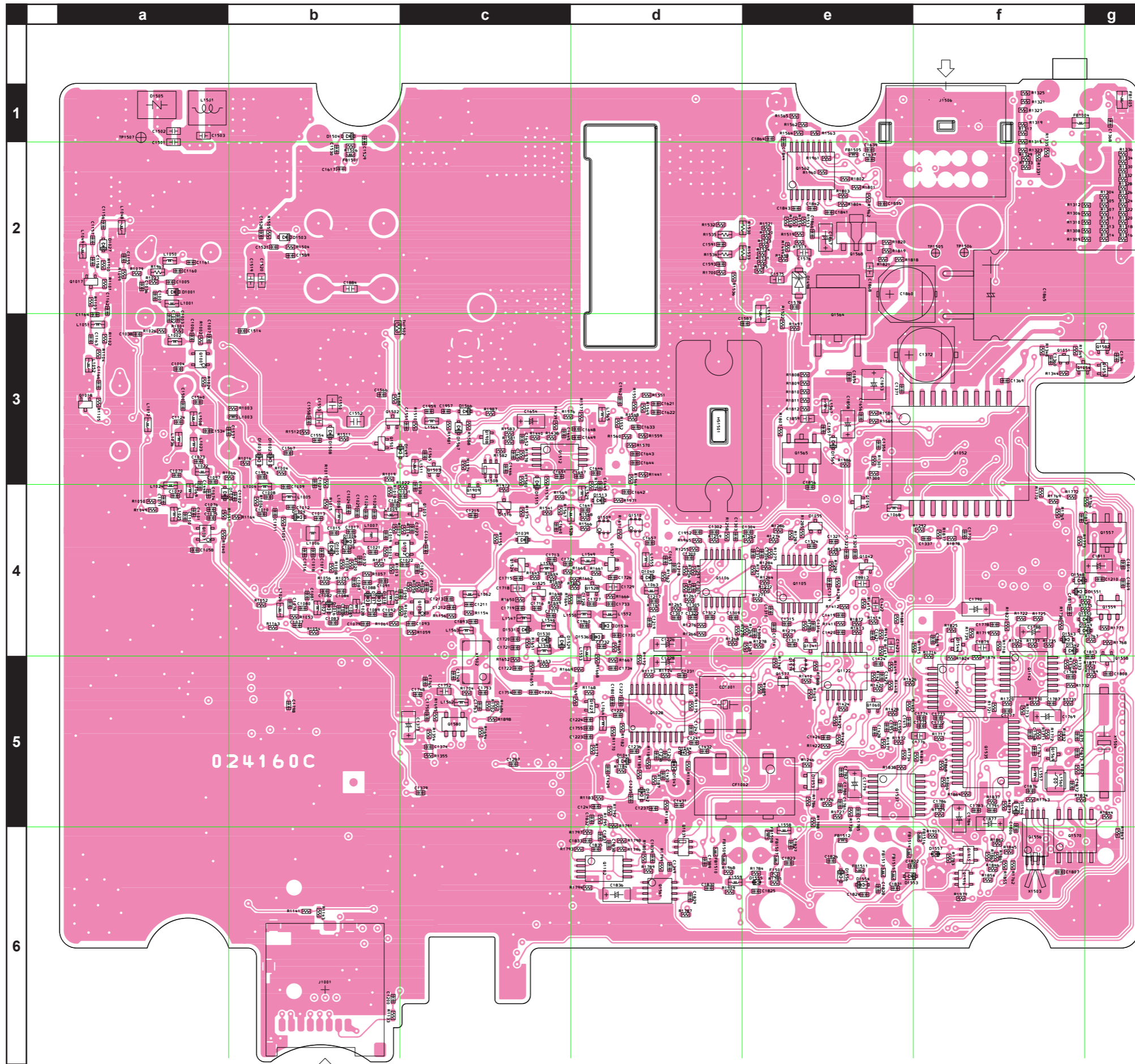

MAIN-3

Side B

FTM-100DR/DE Technical Supplement

MAIN Unit

Parts List

REF	DESCRIPTION	VALUE	V/W	TOL.	MFR'S DESIG	YAESU P/N	VERS.	LOT	SIDE	LAY ADR
	PCB with Components					CS2361703* CS2361704* CS2361708* CS2361705* CS2361709* CS2361706* CS2361707*	USA: A2U EU: B2 EU: B2 EXP: B3 EXP: B3 EU: C2 AUS: H2	1-18 19- 1-18 19- 1-18 1-18		
BT1501	LITHIUM BATT.				ML614R-TT31	Q9000895		1-	A	A6
C 1001	CHIP CAP.	12pF	50V	CH	GRM1552C1H120GA01D	K22179723		1-	B	a2
C 1002	CHIP CAP.	0.001uF	50V	B	GRM155B11H102KA01D	K22178809		1-	B	a3
C 1004	CHIP CAP.	0.001uF	50V	B	GRM155B11H102KA01D	K22178809		1-	B	a3
C 1007	CHIP CAP.	0.001uF	50V	B	GRM155B11H102KA01D	K22178809		1-	B	a3
C 1008	CHIP CAP.	0.001uF	50V	B	GRM155B11H102KA01D	K22178809		1-	B	b4
C 1009	CHIP CAP.	68pF	50V	CH	GRM1552C1H680JA01D	K22178232		1-	B	b4
C 1010	CHIP CAP.	0.001uF	50V	B	GRM155B11H102KA01D	K22178809		1-	B	b4
C 1011	CHIP CAP.	27pF	50V	CH	GRM1552C1H270GA01D	K22179726		1-	B	b4
C 1012	CHIP CAP.	0.75pF	50V	CK	GRM1554C1HR75BA01D	K22178286		1-	B	b4
C 1013	CHIP CAP.	0.5pF	50V	CK	GRM1554C1HR50BA01D	K22178285		1-	B	b4
C 1014	CHIP CAP.	27pF	50V	CH	GRM1552C1H270GA01D	K22179726		1-	B	b4
C 1015	CHIP CAP.	1pF	50V	CK	GRM1554C1H1R0BA01D	K22178287		1-	B	b4
C 1016	CHIP CAP.	0.75pF	50V	CK	GRM1554C1HR75BA01D	K22178286		1-	B	b4
C 1017	CHIP CAP.	0.5pF	50V	CK	GRM1554C1HR50BA01D	K22178285		1-	B	b4
C 1018	CHIP CAP.	0.75pF	50V	CK	GRM1554C1HR75BA01D	K22178286		1-	B	b4
C 1019	CHIP CAP.	0.5pF	50V	CK	GRM1554C1HR50BA01D	K22178285		1-	B	b4
C 1020	CHIP CAP.	27pF	50V	CH	GRM1552C1H270GA01D	K22179726		1-	B	b4
C 1021	CHIP CAP.	18pF	50V	CH	GRM1552C1H180JA01D	K22178218		1-	B	b4
C 1022	CHIP CAP.	0.001uF	50V	B	GRM155B11H102KA01D	K22178809		1-	B	c4
C 1023	CHIP CAP.	0.01uF	25V	B	GRM155B11E103KA01D	K22148834		1-	B	c4
C 1024	CHIP CAP.	0.001uF	50V	B	GRM155B11H102KA01D	K22178809		1-	B	b4
C 1025	CHIP CAP.	7pF	50V	CH	GRM1552C1H7R0BA01D	K22178294		1-	B	b4
C 1026	CHIP CAP.	2pF	50V	CK	GRM1554C1H2R0BA01D	K22178289		1-	B	b4
C 1027	CHIP CAP.	0.001uF	50V	B	GRM155B11H102KA01D	K22178809		1-	B	b4
C 1028	CHIP CAP.	6pF	50V	CH	GRM1552C1H6R0BA01D	K22178293		1-	B	b4
C 1029	CHIP CAP.	22pF	50V	CH	GRM1552C1H220GA01D	K22179707		1-	B	b4
C 1030	CHIP CAP.	0.001uF	50V	B	GRM155B11H102KA01D	K22178809		1-	B	c4
C 1031	CHIP CAP.	0.5pF	50V	CK	GRM1554C1HR50BA01D	K22178285		1-	B	c4
C 1032	CHIP CAP.	0.001uF	50V	B	GRM155B11H102KA01D	K22178809		1-	B	b4
C 1033	CHIP CAP.	0.001uF	50V	B	GRM155B11H102KA01D	K22178809		1-	A	E4
C 1034	CHIP CAP.	6pF	50V	CH	GRM1552C1H6R0BA01D	K22178293		1-	B	c4
C 1035	CHIP CAP.	2pF	50V	CK	GRM1554C1H2R0BA01D	K22178289		1-	B	c4
C 1036	CHIP CAP.	0.001uF	50V	B	GRM155B11H102KA01D	K22178809		1-	B	a2
C 1038	CHIP CAP.	0.001uF	50V	B	GRM155B11H102KA01D	K22178809		1-	B	a3
C 1058	CHIP CAP.	0.001uF	50V	B	GRM155B11H102KA01D	K22178809		1-	B	a4
C 1070	CHIP CAP.	12pF	50V	CH	GRM1552C1H120JA01D	K22178214		1-	B	a3
C 1071	CHIP CAP.	0.001uF	50V	B	GRM155B11H102KA01D	K22178809		1-	B	a4
C 1072	CHIP CAP.	6pF	50V	CH	GRM1552C1H6R0BA01D	K22178293		1-	B	a4
C 1073	CHIP CAP.	8pF	50V	CH	GRM1552C1H8R0BA01D	K22178295		1-	B	a3
C 1074	CHIP CAP.	8pF	50V	CH	GRM1552C1H8R0BA01D	K22178295		1-	B	a4
C 1075	CHIP CAP.	0.001uF	50V	B	GRM155B11H102KA01D	K22178809		1-	B	a4
C 1076	CHIP CAP.	0.1uF	10V	B	GRM155B11A104KA01D	K22108802		1-	B	a4
C 1077	CHIP CAP.	0.001uF	50V	B	GRM155B11H102KA01D	K22178809		1-	B	b4
C 1079	CHIP CAP.	0.001uF	50V	B	GRM155B11H102KA01D	K22178809		1-	B	b4
C 1080	CHIP CAP.	8pF	50V	CH	GRM1552C1H8R0BA01D	K22178295		1-	B	b4
C 1081	CHIP CAP.	1.5pF	50V	CK	GRM1554C1H1R5BA01D	K22178288		1-	B	b4
C 1082	CHIP CAP.	47pF	50V	CH	GRM1552C1H470GA01D	K22179709		1-	B	b4
C 1083	CHIP CAP.	0.75pF	50V	CK	GRM1554C1HR75BA01D	K22178286		1-	B	b4
C 1084	CHIP CAP.	18pF	50V	CH	GRM1552C1H180GA01D	K22179701		1-	B	b4
C 1085	CHIP CAP.	2pF	50V	CK	GRM1554C1H2R0BA01D	K22178289		1-	B	b4
C 1086	CHIP CAP.	0.5pF	50V	CK	GRM1554C1HR50BA01D	K22178285		1-	B	b4
C 1087	CHIP CAP.	47pF	50V	CH	GRM1552C1H470GA01D	K22179709		1-	B	b4
C 1088	CHIP CAP.	8pF	50V	CH	GRM1552C1H8R0BA01D	K22178295		1-	B	b4
C 1089	CHIP CAP.	0.5pF	50V	CK	GRM1554C1HR50BA01D	K22178285		1-	B	b4
C 1090	CHIP CAP.	1.5pF	50V	CK	GRM1554C1H1R5BA01D	K22178288		1-	B	b4
C 1091	CHIP CAP.	47pF	50V	CH	GRM1552C1H470GA01D	K22179709		1-	B	b4
C 1092	CHIP CAP.	15pF	50V	CH	GRM1552C1H150GA01D	K22178300		1-	B	b4
C 1093	CHIP CAP.	0.001uF	50V	B	GRM155B11H102KA01D	K22178809		1-	B	c4
C 1094	CHIP CAP.	0.01uF	25V	B	GRM155B11E103KA01D	K22148834		1-	B	c4
C 1095	CHIP CAP.	0.001uF	50V	B	GRM155B11H102KA01D	K22178809		1-	A	E4
C 1096	CHIP CAP.	7pF	50V	CH	GRM1552C1H7R0BA01D	K22178294		1-	A	E4
C 1097	CHIP CAP.	7pF	50V	CH	GRM1552C1H7R0BA01D	K22178294		1-	B	a3
C 1100	CHIP CAP.	2pF	50V	CK	GRM1554C1H2R0BA01D	K22178289		1-	B	a4
C 1101	CHIP CAP.	9pF	50V	CH	GRM1552C1H9R0BA01D	K22178296		1-	B	a4
C 1102	CHIP CAP.	0.001uF	50V	B	GRM155B11H102KA01D	K22178809		1-	B	b4

* Please contact YAESU when replacing the MAIN-UNIT.

MAIN Unit

Parts List

REF	DESCRIPTION	VALUE	V/W	TOL.	MFR'S DESIG	YAESU P/N	VERS.	LOT	SIDE	LAY ADR
C 1124	CHIP CAP.	12pF	50V	CH	GRM1552C1H120GA01D	K22179723		1-	B	a3
C 1125	CHIP CAP.	9pF	50V	CH	GRM1552C1H9R0BA01D	K22178296		1-	A	F3
C 1126	CHIP CAP.	0.001uF	50V	B	GRM155B11H102KA01D	K22178809		1-	A	F4
C 1128	CHIP CAP.	22pF	50V	CH	GRM1552C1H220GA01D	K22179707		1-	A	F4
C 1129	CHIP CAP.	6pF	50V	CH	GRM1552C1H6R0BA01D	K22178293		1-	A	F4
C 1130	CHIP CAP.	0.001uF	50V	B	GRM155B11H102KA01D	K22178809		1-	A	F4
C 1131	CHIP CAP.	47pF	50V	CH	GRM1552C1H470GA01D	K22179709		1-	A	E4
C 1132	CHIP CAP.	0.001uF	50V	B	GRM155B11H102KA01D	K22178809		1-	A	F4
C 1133	CHIP CAP.	0.001uF	50V	B	GRM155B11H102KA01D	K22178809		1-	A	E4
C 1135	CHIP CAP.	3pF	50V	CJ	GRM1553C1H3R0BA01D	K22178290		1-	A	E4
C 1136	CHIP CAP.	3pF	50V	CJ	GRM1553C1H3R0BA01D	K22178290		1-	A	E4
C 1137	CHIP CAP.	27pF	50V	CH	GRM1552C1H270GA01D	K22179726		1-	A	E4
C 1138	CHIP CAP.	0.5pF	50V	CK	GRM1554C1HR50BA01D	K22178285		1-	A	E4
C 1139	CHIP CAP.	0.001uF	50V	B	GRM155B11H102KA01D	K22178809		1-	A	E4
C 1140	CHIP CAP.	0.001uF	50V	B	GRM155B11H102KA01D	K22178809		1-	A	F4
C 1141	CHIP CAP.	8pF	50V	CH	GRM1552C1H8R0BA01D	K22178295		1-	A	E4
C 1143	CHIP CAP.	0.5pF	50V	CK	GRM1554C1HR50BA01D	K22178285		1-	A	F4
C 1154	CHIP CAP.	2pF	50V	CK	GRM1554C1H2R0BA01D	K22178289		1-	A	F2
C 1155	CHIP CAP.	0.001uF	50V	B	GRM155B11H102KA01D	K22178809		1-	B	a2
C 1156	CHIP CAP.	220pF	50V	CH	GRM1552C1H221JA01D	K22179713		1-	B	a2
C 1157	CHIP CAP.	2pF	50V	CK	GRM1554C1H2R0BA01D	K22178289		1-	B	a2
C 1158	CHIP CAP.	6pF	50V	CH	GRM1552C1H6R0BA01D	K22178293		1-	B	a2
C 1159	CHIP CAP.	2pF	200V	CK	GRM1884C2D2R0CV01D	K22234204		1-	A	F2
C 1159	CHIP CAP.	2pF	250V	C0G	QQM1875C2E2R0CB12D	K22244208		2-	A	F2
C 1161	CHIP CAP.	2pF	50V	CK	GRM1554C1H2R0BA01D	K22178289		1-	B	a2
C 1162	CHIP CAP.	0.001uF	50V	B	GRM155B11H102KA01D	K22178809		1-	B	a2
C 1163	CHIP CAP.	3pF	50V	CJ	GRM1553C1H3R0BA01D	K22178290		1-	B	a3
C 1164	CHIP CAP.	1.5pF	50V	CK	GRM1554C1H1R5BA01D	K22178288		1-	B	a3
C 1165	CHIP CAP.	0.001uF	50V	B	GRM155B11H102KA01D	K22178809		1-	A	F3
C 1166	CHIP CAP.	8pF	50V	CH	GRM1552C1H8R0BA01D	K22178295		1-	B	a3
C 1167	CHIP CAP.	0.001uF	50V	B	GRM155B11H102KA01D	K22178809		1-	A	E4
C 1168	CHIP CAP.	0.001uF	50V	B	GRM155B11H102KA01D	K22178809		1-	A	E4
C 1169	CHIP CAP.	27pF	50V	CH	GRM1552C1H270GA01D	K22179726		1-	A	E4
C 1170	CHIP CAP.	1pF	50V	CK	GRM1554C1H1R0BA01D	K22178287		1-	A	E4
C 1171	CHIP CAP.	10pF	50V	CH	GRM1552C1H100BA01D	K22178297		1-	A	E4
C 1173	CHIP CAP.	27pF	50V	CH	GRM1552C1H270GA01D	K22179726		1-	A	E4
C 1174	CHIP CAP.	15pF	50V	CH	GRM1552C1H150GA01D	K22178300		1-	A	E4
C 1175	CHIP CAP.	0.75pF	50V	CK	GRM1554C1HR75BA01D	K22178286		1-	A	E4
C 1176	CHIP CAP.	10pF	50V	CH	GRM1552C1H100BA01D	K22178297		1-	A	E4
C 1177	CHIP CAP.	2pF	50V	CK	GRM1554C1H2R0BA01D	K22178289		1-	A	E4
C 1178	CHIP CAP.	2pF	50V	CK	GRM1554C1H2R0BA01D	K22178289		1-	A	E4
C 1179	CHIP CAP.	0.001uF	50V	B	GRM155B11H102KA01D	K22178809		1-	A	E4
C 1195	CHIP CAP.	0.001uF	50V	B	GRM155B11H102KA01D	K22178809		1-	A	E4
C 1198	CHIP CAP.	0.1uF	10V	B	GRM155B11A104KA01D	K22108802		1-	A	C6
C 1199	CHIP TA.CAP.	10uF	10V		TAJA106M010Y	K78100072		1-	A	E6
C 1199	CHIP TA.CAP.	10uF	10V		TAJA106M010RNJ	K78100120		26-	A	E6
C 1204	CHIP CAP.	0.1uF	16V	B	GRM188B11C104KA01D	K22124805		1-	A	C6
C 1205	CHIP CAP.	0.1uF	10V	B	GRM155B11A104KA01D	K22108802		1-	A	C6
C 1208	CHIP CAP.	0.1uF	10V	B	GRM155B11A104KA01D	K22108802		1-	A	A4
C 1209	CHIP CAP.	0.1uF	10V	B	GRM155B11A104KA01D	K22108802		1-	A	A4
C 1210	CHIP CAP.	0.1uF	10V	B	GRM155B11A104KA01D	K22108802		1-	B	g4
C 1211	CHIP CAP.	7pF	50V	CH	GRM1552C1H7R0BA01D	K22178294		1-	B	c4
C 1212	CHIP CAP.	0.001uF	50V	B	GRM155B11H102KA01D	K22178809		1-	B	c4
C 1213	CHIP CAP.	0.1uF	10V	B	GRM155B11A104KA01D	K22108802		1-	B	c4
C 1214	CHIP CAP.	7pF	50V	CH	GRM1552C1H7R0BA01D	K22178294		1-	A	D4
C 1215	CHIP CAP.	0.1uF	10V	B	GRM155B11A104KA01D	K22108802		1-	B	c4
C 1216	CHIP CAP.	0.01uF	25V	B	GRM155B11E103KA01D	K22148834		1-	A	D4
C 1217	CHIP CAP.	22pF	50V	CH	GRM1552C1H220GA01D	K22179707		1-	B	d4
C 1218	CHIP CAP.	0.01uF	25V	B	GRM155B11E103KA01D	K22148834		1-	B	d4
C 1219	CHIP CAP.	0.001uF	50V	B	GRM155B11H102KA01D	K22178809		1-	B	d4
C 1220	CHIP CAP.	0.001uF	50V	B	GRM155B11H102KA01D	K22178809		1-	A	C4
C 1221	CHIP CAP.	0.47uF	6.3V	B	GRM155B30J474KE18D	K22088802		1-	A	C4
C 1222	CHIP CAP.	2pF	50V	CK	GRM1554C1H2R0BA01D	K22178289		1-	B	c5
C 1223	CHIP CAP.	0.01uF	25V	B	GRM155B11E103KA01D	K22148834		1-	B	d5
C 1224	CHIP CAP.	22pF	50V	CH	GRM1552C1H220GA01D	K22179707		1-	B	d5
C 1225	CHIP CAP.	100pF	50V	CH	GRM1552C1H101JA01D	K22178236		1-	B	d5
C 1226	CHIP TA.CAP.	22uF	6.3V		TMCMA0J226MTRF	K78080047		1-	B	d5
C 1227	CHIP CAP.	0.01uF	25V	B	GRM155B11E103KA01D	K22148834		1-	B	d4
C 1228	CHIP TA.CAP.	10uF	10V		TAJA106M010Y	K78100072		1-	B	d5
C 1228	CHIP TA.CAP.	10uF	10V		TAJA106M010RNJ	K78100120		26-	B	d5
C 1229	CHIP CAP.	220pF	50V	CH	GRM1552C1H221JA01D	K22179713		1-	A	C5
C 1230	CHIP CAP.	220pF	50V	CH	GRM1552C1H221JA01D	K22179713		1-	A	C5
C 1231	CHIP CAP.	0.01uF	25V	B	GRM155B11E103KA01D	K22148834		1-	B	d5

MAIN Unit

Parts List

REF	DESCRIPTION	VALUE	V/W	TOL.	MFR'S DESIG	YAESU P/N	VERS.	LOT	SIDE	LAY ADR
C 1232	CHIP CAP.	0.0047uF	50V	B	GRM155B11H472KA01D	K22178838		1-	A	C5
C 1233	CHIP CAP.	0.1uF	10V	B	GRM155B11A104KA01D	K22108802		1-	A	C5
C 1234	CHIP CAP.	1uF	6.3V	B	GRM155B30J105KE18D	K22088803		1-	A	C5
C 1235	CHIP CAP.	0.01uF	25V	B	GRM155B11E103KA01D	K22148834		1-	B	d5
C 1236	CHIP CAP.	0.01uF	25V	B	GRM155B11E103KA01D	K22148834		1-	B	d5
C 1237	CHIP CAP.	1uF	6.3V	B	GRM155B30J105KE18D	K22088803		1-	B	d5
C 1238	CHIP CAP.	0.01uF	25V	B	GRM155B11E103KA01D	K22148834		1-	B	d5
C 1239	CHIP CAP.	0.1uF	10V	B	GRM155B11A104KA01D	K22108802		1-	A	C5
C 1240	CHIP CAP.	0.01uF	25V	B	GRM155B11E103KA01D	K22148834		1-	B	d5
C 1241	CHIP CAP.	0.1uF	10V	B	GRM155B11A104KA01D	K22108802		1-	B	d5
C 1242	CHIP CAP.	100pF	50V	CH	GRM1552C1H101JA01D	K22178236		1-	B	d5
C 1243	CHIP CAP.	22pF	50V	CH	GRM1552C1H220GA01D	K22179707		1-	A	C5
C 1244	CHIP CAP.	0.001uF	50V	B	GRM155B11H102KA01D	K22178809		1-	A	C5
C 1245	CHIP CAP.	0.001uF	50V	B	GRM155B11H102KA01D	K22178809		1-	A	C5
C 1246	CHIP CAP.	0.1uF	10V	B	GRM155B11A104KA01D	K22108802		1-	A	D6
C 1247	CHIP CAP.	0.001uF	50V	B	GRM155B11H102KA01D	K22178809		1-	B	d5
C 1285	CHIP CAP.	0.001uF	50V	B	GRM155B11H102KA01D	K22178809		1-	A	E5
C 1286	CHIP CAP.	0.001uF	50V	B	GRM155B11H102KA01D	K22178809		1-	A	E5
C 1287	CHIP CAP.	0.001uF	50V	B	GRM155B11H102KA01D	K22178809		1-	B	c5
C 1288	CHIP CAP.	0.0056uF	25V	B	GRM155B11E562KA01D	K22148802		1-	A	C5
C 1289	CHIP CAP.	0.001uF	50V	B	GRM155B11H102KA01D	K22178809		1-	A	C5
C 1290	CHIP CAP.	1uF	6.3V	B	GRM155B30J105KE18D	K22088803		1-	A	D6
C 1291	CHIP CAP.	0.1uF	10V	B	GRM155B11A104KA01D	K22108802		1-	A	C5
C 1292	CHIP CAP.	0.1uF	10V	B	GRM155B11A104KA01D	K22108802		1-	A	C5
C 1293	CHIP CAP.	0.0022uF	50V	B	GRM155B11H222KA01D	K22178813		1-	A	C5
C 1294	CHIP CAP.	0.1uF	10V	B	GRM155B11A104KA01D	K22108802		1-	A	B5
C 1295	CHIP CAP.	0.01uF	25V	B	GRM155B11E103KA01D	K22148834		1-	A	C5
C 1296	CHIP CAP.	0.047uF	10V	B	GRM155B11A473KA01D	K22108801		1-	A	C5
C 1297	CHIP CAP.	0.1uF	10V	B	GRM155B11A104KA01D	K22108802		1-	A	C5
C 1298	CHIP CAP.	0.1uF	10V	B	GRM155B11A104KA01D	K22108802		1-	A	C4
C 1299	CHIP CAP.	0.0047uF	50V	B	GRM155B11H472KA01D	K22178838		1-	A	C4
C 1300	CHIP CAP.	150pF	50V	CH	GRM1552C1H151JA01D	K22178240		1-	B	d4
C 1301	CHIP CAP.	1uF	6.3V	B	GRM155B30J105KE18D	K22088803		1-	B	d4
C 1302	CHIP CAP.	0.0047uF	50V	B	GRM155B11H472KA01D	K22178838		1-	B	d4
C 1303	CHIP CAP.	0.0047uF	50V	B	GRM155B11H472KA01D	K22178838		1-	B	d4
C 1304	CHIP CAP.	0.0047uF	50V	B	GRM155B11H472KA01D	K22178838		1-	B	e4
C 1305	CHIP CAP.	4.7uF	4V	BJ	AMK105BJ475MV-F	K22068801		1-	B	d4
C 1306	CHIP CAP.	1uF	6.3V	B	GRM155B30J105KE18D	K22088803		1-	B	e4
C 1307	CHIP CAP.	1uF	6.3V	B	GRM155B30J105KE18D	K22088803		1-	B	d4
C 1308	CHIP CAP.	0.0039uF	50V	B	GRM155B11H392KA01D	K22178816		1-	B	e4
C 1309	CHIP CAP.	56pF	50V	CH	GRM1552C1H560JA01D	K22178230		1-	B	d4
C 1310	CHIP CAP.	0.001uF	50V	B	GRM155B11H102KA01D	K22178809		1-	B	e4
C 1311	CHIP CAP.	0.1uF	10V	B	GRM155B11A104KA01D	K22108802		1-	B	e4
C 1312	CHIP CAP.	0.0027uF	50V	B	GRM155B11H272KA01D	K22178814		1-	B	d4
C 1314	CHIP CAP.	0.022uF	16V	B	GRM155B11C223KA01D	K22128806		1-	B	e4
C 1315	CHIP CAP.	220pF	50V	CH	GRM1552C1H221JA01D	K22179713		1-	B	e4
C 1316	CHIP CAP.	0.015uF	16V	B	GRM155B11C153KA01D	K22128807		1-	B	e4
C 1317	CHIP CAP.	560pF	50V	B	GRM155B11H561KA01D	K22178806		1-	B	e4
C 1318	CHIP CAP.	0.047uF	10V	B	GRM155B11A473KA01D	K22108801		1-	A	C5
C 1319	CHIP CAP.	0.022uF	16V	B	GRM155B11C223KA01D	K22128806		1-	B	e4
C 1320	CHIP CAP.	560pF	50V	B	GRM155B11H561KA01D	K22178806		1-	B	e4
C 1321	CHIP CAP.	0.015uF	16V	B	GRM155B11C153KA01D	K22128807		1-	B	e4
C 1322	CHIP CAP.	0.01uF	16V	B	GRM155B11C103JA01D	K22128814		1-	B	d4
C 1323	CHIP CAP.	220pF	50V	CH	GRM1552C1H221JA01D	K22179713		1-	B	e4
C 1324	CHIP CAP.	0.047uF	10V	B	GRM155B11A473KA01D	K22108801		1-	B	e4
C 1325	CHIP CAP.	2pF	50V	CK	GRM1554C1H2R0BA01D	K22178289		1-	A	F4
C 1326	CHIP CAP.	1uF	10V	B	GRM155B31A105KE15D	K22108809		1-	A	B4
C 1327	CHIP CAP.	1uF	10V	B	GRM155B31A105KE15D	K22108809		1-	A	B3
C 1328	CHIP CAP.	0.047uF	10V	B	GRM155B11A473KA01D	K22108801		1-	A	B4
C 1329	CHIP CAP.	0.022uF	16V	B	GRM155B11C223KA01D	K22128806		1-	A	A4
C 1330	CHIP CAP.	0.0047uF	50V	B	GRM155B11H472KA01D	K22178838		1-	A	B4
C 1331	CHIP CAP.	0.022uF	16V	B	GRM155B11C223KA01D	K22128806		1-	A	B4
C 1332	CHIP CAP.	1uF	6.3V	B	GRM155B30J105KE18D	K22088803		1-	A	A4
C 1333	CHIP CAP.	0.1uF	10V	B	GRM155B11A104KA01D	K22108802		1-	A	A4
C 1334	CHIP TA.CAP.	47uF	6.3V		TMCMA0J476MTRF	K78080085		1-	A	B3
C 1336	CHIP CAP.	0.047uF	10V	B	GRM155B11A473KA01D	K22108801		1-	A	B4
C 1337	CHIP CAP.	0.047uF	10V	B	GRM155B11A473KA01D	K22108801		1-	B	f4
C 1338	CHIP CAP.	0.1uF	10V	B	GRM155B11A104KA01D	K22108802		1-	A	C4
C 1339	CHIP CAP.	0.01uF	25V	B	GRM155B11E103KA01D	K22148834		1-	A	B3
C 1345	CHIP CAP.	1uF	6.3V	B	GRM155B30J105KE18D	K22088803		1-	A	A3
C 1347	CHIP TA.CAP.	22uF	16V		TMCMB1C226MTRF	K78120028		1-	A	B3
C 1347	CHIP CAP.	22uF	25V	X5R	GRM21BR61E226ME44L	K22140830		3-	A	B3
C 1348	CHIP CAP.	0.01uF	25V	B	GRM155B11E103KA01D	K22148834		1-	A	B3

MAIN Unit

Parts List

REF	DESCRIPTION	VALUE	V/W	TOL.	MFR'S DESIG	YAESU P/N	VERS.	LOT	SIDE	LAY ADR
C 1349	CHIP CAP.	0.001uF	50V	B	GRM155B11H102KA01D	K22178809		1-	B	d6
C 1350	CHIP CAP.	1uF	6.3V	B	GRM155B30J105KE18D	K22088803		1-	B	e3
C 1351	CHIP CAP.	1uF	6.3V	B	GRM155B30J105KE18D	K22088803		1-	A	B3
C 1352	CHIP CAP.	0.001uF	50V	B	GRM155B11H102KA01D	K22178809		1-	A	A2
C 1353	CHIP CAP.	0.001uF	50V	B	GRM155B11H102KA01D	K22178809		1-	A	A2
C 1354	CHIP CAP.	1uF	6.3V	B	GRM155B30J105KE18D	K22088803		1-	A	A4
C 1355	CHIP CAP.	0.1uF	10V	B	GRM155B11A104KA01D	K22108802		1-	A	A3
C 1356	CHIP CAP.	0.022uF	16V	B	GRM155B11C223KA01D	K22128806		1-	A	A4
C 1359	CHIP CAP.	0.1uF	10V	B	GRM155B11A104KA01D	K22108802		1-	A	A3
C 1360	CHIP CAP.	0.047uF	10V	B	GRM155B11A473KA01D	K22108801		1-	B	f3
C 1362	CHIP CAP.	0.1uF	10V	B	GRM155B11A104KA01D	K22108802		1-	A	D5
C 1364	AL.ELECTRO.CAP.	470uF	10V		RVZ-10V471M	K48100010		1-	A	A2
C 1366	AL.ELECTRO.CAP.	470uF	10V		RVZ-10V471M	K48100010		1-	A	A3
C 1367	AL.ELECTRO.CAP.	220uF	16V		EMVA160ADA221MF80G	K48120021		1-	A	A3
C 1368	CHIP CAP.	0.001uF	50V	B	GRM155B11H102KA01D	K22178809		1	B	g1
C 1368	CHIP CAP.	0.01uF	25V	B	GRM155B11E103KA01D	K22148834	W/ CE	2-	B	g1
C 1368	CHIP CAP.	0.001uF	50V	B	GRM155B11H102KA01D	K22178809	W/O CE	2-	B	g1
C 1369	CHIP CAP.	0.001uF	50V	B	GRM155B11H102KA01D	K22178809		1-	B	f3
C 1370	CHIP CAP.	0.001uF	50V	B	GRM155B11H102KA01D	K22178809		1	A	A2
C 1370	CHIP CAP.	0.01uF	25V	B	GRM155B11E103KA01D	K22148834	W/ CE	2-	A	A2
C 1370	CHIP CAP.	0.001uF	50V	B	GRM155B11H102KA01D	K22178809	W/O CE	2-	A	A2
C 1371	CHIP CAP.	100pF	50V	CH	GRM1552C1H101JA01D	K22178236		1-	B	e3
C 1372	AL.ELECTRO.CAP.	100uF	10V		RVZ-10V101MF55U-R2	K48100008		1-	B	f3
C 1373	CHIP TA.CAP.	10uF	10V		TAJA106M010Y	K78100072		1-	B	c5
C 1373	CHIP TA.CAP.	10uF	10V		TAJA106M010RNJ	K78100120		26-	B	c5
C 1374	CHIP CAP.	1uF	6.3V	B	GRM155B30J105KE18D	K22088803		1-	B	c5
C 1375	CHIP CAP.	47pF	50V	CH	GRM1552C1H470JA01D	K22178228		1-	A	E5
C 1376	CHIP CAP.	0.001uF	50V	B	GRM155B11H102KA01D	K22178809		1-	A	E5
C 1379	CHIP CAP.	1uF	6.3V	B	GRM155B30J105KE18D	K22088803		1-	B	c5
C 1389	CHIP CAP.	0.001uF	50V	B	GRM155B11H102KA01D	K22178809		1-	B	d6
C 1415	CHIP CAP.	0.01uF	25V	B	GRM155B11E103KA01D	K22148834		1-	B	e4
C 1416	CHIP CAP.	0.1uF	10V	B	GRM155B11A104KA01D	K22108802		1-	A	C5
C 1418	CHIP CAP.	0.1uF	10V	B	GRM155B11A104KA01D	K22108802		1-	A	C4
C 1419	CHIP CAP.	820pF	50V	B	GRM155B11H821KA01D	K22178808		1-	B	e4
C 1420	CHIP CAP.	47pF	50V	CH	GRM1552C1H470GA01D	K22179709		1-	B	e4
C 1421	CHIP CAP.	36pF	50V	CH	GRM1552C1H360JA01D	K22178225		1-	B	e4
C 1422	CHIP CAP.	0.001uF	50V	CH	GRM1882C1H102JA01D	K22174275		1-	B	e4
C 1423	CHIP CAP.	560pF	50V	CH	GRM1882C1H561JA01D	K22174273		1-	B	e4
C 1424	CHIP CAP.	0.1uF	10V	B	GRM155B11A104KA01D	K22108802		1-	B	e5
C 1425	CHIP CAP.	15pF	50V	CH	GRM1552C1H150GA01D	K22178300		1-	B	e5
C 1426	CHIP CAP.	1uF	6.3V	B	GRM155B30J105KE18D	K22088803		1-	B	e5
C 1427	CHIP CAP.	0.001uF	50V	B	GRM155B11H102KA01D	K22178809		1-	A	B4
C 1428	CHIP CAP.	0.01uF	25V	B	GRM155B11E103KA01D	K22148834		1-	B	e5
C 1429	CHIP CAP.	0.01uF	25V	B	GRM155B11E103KA01D	K22148834		1-	B	d5
C 1430	CHIP CAP.	0.01uF	25V	B	GRM155B11E103KA01D	K22148834		1-	B	d5
C 1431	CHIP CAP.	0.01uF	25V	B	GRM155B11E103KA01D	K22148834		1-	B	d5
C 1432	CHIP CAP.	0.01uF	25V	B	GRM155B11E103KA01D	K22148834		1-	B	d5
C 1445	CHIP CAP.	0.001uF	50V	B	GRM155B11H102KA01D	K22178809		1-	B	c3
C 1446	CHIP CAP.	0.001uF	50V	B	GRM155B11H102KA01D	K22178809		1-	B	c3
C 1448	CHIP CAP.	22pF	50V	CH	GRM1552C1H220GA01D	K22179707		1-	B	a4
C 1491	CHIP CAP.	0.1uF	10V	B	GRM155B11A104KA01D	K22108802		1-	A	C5
C 1499	CHIP CAP.	1pF	250V	C0G	GQM1875C2E1R0CB12D	K22244206		9-	A	F2
C 1500	CHIP CAP.	0.001uF	50V	B	GRM155B11H102KA01D	K22178809		1-	B	a3
C 1501	CHIP CAP.	4pF	200V	CH	GRM1882C2D4R0CV01D	K22234206		1	B	a2
C 1501	CHIP CAP.	4pF	250V	C0G	GQM1875C2E4R0CB12D	K22244212		2-	B	a2
C 1502	CHIP CAP.	4pF	200V	CH	GRM1882C2D4R0CV01D	K22234206		1	B	a1
C 1502	CHIP CAP.	4pF	250V	C0G	GQM1875C2E4R0CB12D	K22244212		2-	B	a1
C 1504	CHIP CAP.	1.5pF	200V	CK	GRM1884C2D1R5CV01D	K22234213		1	A	F2
C 1504	CHIP CAP.	1.5pF	250V	C0G	GQM1875C2E1R5CB12D	K22244226		2-	A	F2
C 1505	CHIP CAP.	3pF	200V	CJ	GRM1883C2D3R0CV01D	K22234205		1	A	F2
C 1505	CHIP CAP.	3pF	250V	C0G	GQM1875C2E3R0CB12D	K22244210		2-	A	F2
C 1506	CHIP CAP.	0.5pF	200V	CK	GRM1884C2DR50CY21D	K22234201		1	A	F2
C 1506	CHIP CAP.	0.5pF	250V	C0G	GQM1875C2ER50CB12D	K22244202		2-	A	F2
C 1507	CHIP CAP.	2pF	200V	CK	GRM1884C2D2R0CV01D	K22234204		1	A	F2
C 1507	CHIP CAP.	2pF	250V	C0G	GQM1875C2E2R0CB12D	K22244208		2-	A	F2
C 1508	CHIP CAP.	2pF	200V	CK	GRM1884C2D2R0CV01D	K22234204		1	A	F2
C 1508	CHIP CAP.	2pF	250V	C0G	GQM1875C2E2R0CB12D	K22244208		2-	A	F2
C 1509	CHIP CAP.	4pF	200V	CH	GRM1882C2D4R0CV01D	K22234206		1	A	F2
C 1509	CHIP CAP.	4pF	250V	C0G	GQM1875C2E4R0CB12D	K22244212		2-	A	F2
C 1510	CHIP CAP.	4pF	200V	CH	GRM1882C2D4R0CV01D	K22234206		1	A	F2
C 1510	CHIP CAP.	4pF	250V	C0G	GQM1875C2E4R0CB12D	K22244212		2-	A	F2
C 1511	CHIP CAP.	1pF	200V	CK	GRM1884C2D1R0CV01D	K22234203		1	A	F2
C 1511	CHIP CAP.	1pF	250V	C0G	GQM1875C2E1R0CB12D	K22244206		2-	A	F2

MAIN Unit

Parts List

REF	DESCRIPTION	VALUE	V/W	TOL.	MFR'S DESIG	YAESU P/N	VERS.	LOT	SIDE	LAY ADR
C 1512	CHIP CAP.	3pF	200V	CJ	GRM1883C2D3R0CV01D	K22234205		1	A	F2
C 1512	CHIP CAP.	3pF	250V	C0G	GQM1875C2E3R0CB12D	K22244210		2-13	A	F2
C 1512	CHIP CAP.	2pF	250V	C0G	GQM1875C2E2R0CB12D	K22244208		14-	A	F2
C 1514	CHIP CAP.	0.001uF	50V	B	GRM155B11H102KA01D	K22178809		1-	B	b3
C 1515	CHIP CAP.	2pF	200V	CK	GRM1884C2D2R0CV01D	K22234204		1	A	E2
C 1515	CHIP CAP.	2pF	250V	C0G	GQM1875C2E2R0CB12D	K22244208		2-	A	E2
C 1516	CHIP CAP.	0.5pF	200V	CK	GRM1884C2DR50CY21D	K22234201		1	A	F2
C 1516	CHIP CAP.	0.5pF	250V	C0G	GQM1875C2ER50CB12D	K22244202		2-	A	F2
C 1517	CHIP CAP.	8pF	50V	CH	GRM1552C1H8R0BA01D	K22178295		1-	A	E2
C 1518	CHIP CAP.	0.001uF	50V	B	GRM155B11H102KA01D	K22178809		1-	A	E2
C 1519	CHIP CAP.	3pF	200V	CJ	GRM1883C2D3R0CV01D	K22234205		1	B	b2
C 1519	CHIP CAP.	3pF	250V	C0G	GQM1875C2E3R0CB12D	K22244210		2-	B	b2
C 1520	CHIP CAP.	2pF	200V	CK	GRM1884C2D2R0CV01D	K22234204		1	B	b2
C 1520	CHIP CAP.	2pF	250V	C0G	GQM1875C2E2R0CB12D	K22244208		2-	B	b2
C 1521	CHIP CAP.	0.001uF	50V	B	GRM155B11H102KA01D	K22178809		1-	B	b2
C 1523	CHIP CAP.	2pF	200V	CK	GRM1884C2D2R0CV01D	K22234204		1	A	E3
C 1523	CHIP CAP.	2pF	250V	C0G	GQM1875C2E2R0CB12D	K22244208		2-	A	E3
C 1524	CHIP CAP.	100pF	200V	CH	GRM21B2C2D101JV01L	K22230228		1	A	E2
C 1524	CHIP CAP.	100pF	250V	C0G	GQM2195C2E101GB12D	K22240285		2-	A	E2
C 1525	CHIP CAP.	4pF	250V	C0G	GQM2195C2E4R0BB12D	K22240227		1-	A	E2
C 1526	CHIP CAP.	3pF	250V	C0G	GQM2195C2E3R0BB12D	K22240226		1-	A	E2
C 1527	CHIP CAP.	0.5pF	200V	CK	GRM1884C2DR50CY21D	K22234201		1	A	F2
C 1527	CHIP CAP.	0.5pF	250V	C0G	GQM1875C2ER50CB12D	K22244202		2-	A	F2
C 1528	CHIP CAP.	8pF	50V	CH	GRM1552C1H8R0BA01D	K22178295		1-	B	b2
C 1529	CHIP CAP.	0.001uF	50V	B	GRM155B11H102KA01D	K22178809		1-	B	b1
C 1530	CHIP CAP.	0.001uF	50V	B	GRM155B11H102KA01D	K22178809		1-	B	b2
C 1531	CHIP CAP.	100pF	200V	CH	GRM21B2C2D101JV01L	K22230228		1	A	E2
C 1531	CHIP CAP.	100pF	250V	C0G	GQM2195C2E101GB12D	K22240285		2-	A	E2
C 1532	CHIP CAP.	4pF	250V	C0G	GQM2195C2E4R0BB12D	K22240227		1-	A	E2
C 1533	CHIP CAP.	10pF	200V	CH	GRM2192C2D100JV01D	K22230216		1	A	G2
C 1533	CHIP CAP.	10pF	250V	C0G	GQM2195C2E100JB12D	K22240253		2-	A	G2
C 1534	CHIP CAP.	22pF	50V	CH	GRM1552C1H220JA01D	K22178220		1-	B	a3
C 1535	CHIP CAP.	10pF	200V	CH	GRM2192C2D100JV01D	K22230216		1	A	G2
C 1535	CHIP CAP.	10pF	250V	C0G	GQM2195C2E100JB12D	K22240253		2-	A	G2
C 1537	CHIP CAP.	0.001uF	50V	B	GRM155B11H102KA01D	K22178809		1-	B	a3
C 1539	CHIP CAP.	0.001uF	50V	B	GRM155B11H102KA01D	K22178809		1-	A	G3
C 1540	CHIP CAP.	18pF	50V	CH	GRM1552C1H180GA01D	K22179701		1-	B	a3
C 1541	CHIP CAP.	12pF	200V	CH	GRM2192C2D120JV01D	K22230217		1	A	E3
C 1541	CHIP CAP.	12pF	250V	C0G	GQM2195C2E120JB12D	K22240233		2-	A	E3
C 1542	CHIP CAP.	0.001uF	50V	B	GRM155B11H102KA01D	K22178809		1-	A	F3
C 1543	CHIP CAP.	0.001uF	100V	CH	GRM2192C2A102JA01D	K22200203		1-	A	E3
C 1544	CHIP CAP.	0.5pF	200V	CK	GRM1884C2DR50CY21D	K22234201		1	A	F3
C 1544	CHIP CAP.	0.5pF	250V	C0G	GQM1875C2ER50CB12D	K22244202		2-	A	F3
C 1545	CHIP CAP.	8pF	50V	CH	GRM1552C1H8R0BA01D	K22178295		1-	A	F3
C 1546	CHIP CAP.	10pF	200V	CH	GRM2192C2D100JV01D	K22230216		1	A	E3
C 1546	CHIP CAP.	10pF	250V	C0G	GQM2195C2E100JB12D	K22240253		2-	A	E3
C 1547	CHIP CAP.	9pF	200V	CH	GRM2192C2D9R0DV01D	K22230215		1	A	F3
C 1547	CHIP CAP.	9pF	250V	C0G	GQM2195C2E9R0DB12D	K22240252		2-	A	F3
C 1548	CHIP CAP.	0.001uF	50V	B	GRM155B11H102KA01D	K22178809		1-	A	F3
C 1549	CHIP CAP.	12pF	200V	CH	GRM2192C2D120JV01D	K22230217		1	A	E3
C 1549	CHIP CAP.	12pF	250V	C0G	GQM2195C2E120JB12D	K22240233		2-	A	E3
C 1550	CHIP CAP.	12pF	200V	CH	GRM2192C2D120JV01D	K22230217		1	B	b3
C 1550	CHIP CAP.	12pF	250V	C0G	GQM2195C2E120JB12D	K22240233		2-	B	b3
C 1551	CHIP CAP.	0.001uF	50V	B	GRM155B11H102KA01D	K22178809		1-	B	c3
C 1552	CHIP CAP.	3pF	200V	CJ	GRM2193C2D3R0CY21D	K22230210		1	B	b3
C 1552	CHIP CAP.	3pF	250V	C0G	GQM2195C2E3R0CB12D	K22240246		2-	B	b3
C 1553	CHIP CAP.	0.5pF	200V	CK	GRM1884C2DR50CY21D	K22234201		1	B	b3
C 1553	CHIP CAP.	0.5pF	250V	C0G	GQM1875C2ER50CB12D	K22244202		2-	B	b3
C 1554	CHIP CAP.	0.001uF	50V	B	GRM155B11H102KA01D	K22178809		1-	A	E3
C 1555	CHIP CAP.	0.001uF	100V	CH	GRM2192C2A102JA01D	K22200203		1-	A	b3
C 1557	CHIP CAP.	12pF	200V	CH	GRM2192C2D120JV01D	K22230217		1	A	E3
C 1557	CHIP CAP.	12pF	250V	C0G	GQM2195C2E120JB12D	K22240233		2-	A	E3
C 1558	CHIP CAP.	8pF	50V	CH	GRM1552C1H8R0BA01D	K22178295		1-	B	b3
C 1559	CHIP CAP.	12pF	200V	CH	GRM2192C2D120JV01D	K22230217		1	A	E3
C 1559	CHIP CAP.	12pF	250V	C0G	GQM2195C2E120JB12D	K22240233		2-	A	E3
C 1560	CHIP CAP.	33pF	250V	C0G	GQM2195C2E330GB12D	K22240231		1-	A	D2
C 1561	CHIP CAP.	33pF	250V	C0G	GQM2195C2E330GB12D	K22240231		1-	A	E2
C 1562	CHIP CAP.	27pF	250V	C0G	GQM2195C2E270GB12D	K22240230		1-	A	D2
C 1563	CHIP CAP.	3pF	200V	CJ	GRM1883C2D3R0CV01D	K22234205		1	A	E2
C 1563	CHIP CAP.	3pF	250V	C0G	GQM1875C2E3R0CB12D	K22244210		2-	A	E2
C 1564	CHIP CAP.	10pF	200V	CH	GRM1882C2D100JV01D	K22234212		1	A	E2
C 1564	CHIP CAP.	10pF	250V	C0G	GQM1875C2E100JB12D	K22244224		2-	A	E2
C 1565	CHIP CAP.	0.001uF	50V	B	GRM155B11H102KA01D	K22178809		1-	B	c3

MAIN Unit

Parts List

REF	DESCRIPTION	VALUE	V/W	TOL.	MFR'S DESIG	YAESU P/N	VERS.	LOT	SIDE	LAY ADR
C 1566	CHIP CAP.	0.001uF	50V	B	GRM155B11H102KA01D	K22178809		1-	B	b3
C 1567	CHIP CAP.	0.001uF	50V	B	GRM155B11H102KA01D	K22178809		1-	B	b3
C 1569	CHIP CAP.	33pF	50V	CH	GRM1882C1H330JA01D	K22174223		1-	A	C3
C 1570	CHIP CAP.	39pF	50V	CH	GRM1882C1H390JA01D	K22174225		1-	A	C3
C 1571	CHIP CAP.	22pF	50V	CH	GRM1882C1H220JA01D	K22174219		1-	A	C3
C 1572	CHIP CAP.	22pF	50V	CH	GRM1882C1H220JA01D	K22174219		1-	A	C3
C 1573	CHIP CAP.	7pF	50V	CH	GRM1552C1H7R0BA01D	K22178294		1-	A	B3
C 1574	CHIP CAP.	6pF	50V	CH	GRM1552C1H6R0BA01D	K22178293		1-	A	B3
C 1575	CHIP CAP.	33pF	50V	CH	GRM1882C1H330JA01D	K22174223		1-	B	e2
C 1576	CHIP CAP.	82pF	50V	CH	GRM1882C1H820JA01D	K22174233		1-	B	e2
C 1577	CHIP CAP.	27pF	50V	CH	GRM1882C1H270JA01D	K22174221		1-	A	B2
C 1578	CHIP CAP.	0.001uF	50V	B	GRM155B11H102KA01D	K22178809		1-	B	e2
C 1579	CHIP CAP.	27pF	50V	CH	GRM1882C1H270JA01D	K22174221		1-	A	B2
C 1580	CHIP CAP.	33pF	50V	CH	GRM1882C1H330JA01D	K22174223		1-	A	C3
C 1581	CHIP CAP.	100pF	50V	CH	GRM1882C1H101JA01D	K22174235		1-	A	C3
C 1582	CHIP CAP.	39pF	50V	CH	GRM1882C1H390JA01D	K22174225		1-	A	C3
C 1583	CHIP CAP.	0.001uF	50V	B	GRM155B11H102KA01D	K22178809		1-	B	e3
C 1584	CHIP CAP.	15pF	250V	C0G	GQM2195C2E150JB12D	K22240234		1-	A	C2
C 1585	CHIP CAP.	100pF	50V	CH	GRM1882C1H101JA01D	K22174235		1-	A	C2
C 1586	CHIP CAP.	27pF	250V	C0G	GQM2195C2E270JB12D	K22240237		1-	A	C2
C 1587	CHIP CAP.	100pF	50V	CH	GRM1882C1H101JA01D	K22174235		1-	A	C2
C 1588	CHIP CAP.	100pF	50V	CH	GRM1882C1H101JA01D	K22174235		1-	A	C2
C 1589	CHIP CAP.	0.001uF	50V	B	GRM155B11H102KA01D	K22178809		1-	B	b2
C 1590	CHIP CAP.	470pF	50V	CH	GRM1882C1H471JA01D	K22174249		1-	A	C2
C 1591	CHIP CAP.	0.001uF	50V	B	GRM155B11H102KA01D	K22178809		1-	B	d2
C 1593	CHIP CAP.	0.1uF	10V	B	GRM155B11A104KA01D	K22108802		1-	B	d2
C 1594	CHIP CAP.	0.001uF	50V	CH	GRM1882C1H102JA01D	K22174275		1-	A	C2
C 1595	CHIP CAP.	100pF	50V	CH	GRM1882C1H101JA01D	K22174235		1-	A	C2
C 1596	CHIP CAP.	0.001uF	50V	CH	GRM1882C1H102JA01D	K22174275		1-	A	C2
C 1597	CHIP CAP.	15pF	250V	C0G	GQM2195C2E150JB12D	K22240234		1-	A	C2
C 1598	CHIP CAP.	100pF	50V	CH	GRM1882C1H101JA01D	K22174235		1-	A	C2
C 1599	CHIP CAP.	100pF	50V	CH	GRM1882C1H101JA01D	K22174235		1-	A	C2
C 1600	CHIP CAP.	27pF	250V	C0G	GQM2195C2E270JB12D	K22240237		1-	A	C2
C 1602	CHIP CAP.	27pF	250V	C0G	GQM2195C2E270JB12D	K22240237		1-	A	D2
C 1603	CHIP CAP.	22pF	250V	C0G	GQM2195C2E220JB12D	K22240236		1-	A	D2
C 1604	CHIP CAP.	2pF	250V	C0G	GQM2195C2E2R0BB12D	K22240225		1-13	A	D2
C 1606	CHIP CAP.	27pF	250V	C0G	GQM2195C2E270JB12D	K22240237		1-	A	D2
C 1607	CHIP CAP.	22pF	250V	C0G	GQM2195C2E220JB12D	K22240236		1-	A	D2
C 1608	CHIP CAP.	2pF	250V	C0G	GQM2195C2E2R0BB12D	K22240225		1-	A	D2
C 1612	CHIP CAP.	1uF	25V	B	GRM21BB31E105KA98L	K22140826		1-	A	D1
C 1613	CHIP CAP.	0.047uF	25V	B	GRM188B11E473KA01D	K22144811		1-	A	D1
C 1614	CHIP CAP.	150pF	50V	CH	GRM1552C1H151JA01D	K22178240		1-	A	D1
C 1615	CHIP CAP.	150pF	50V	CH	GRM1552C1H151JA01D	K22178240		1-	A	D1
C 1616	CHIP CAP.	0.001uF	50V	B	GRM155B11H102KA01D	K22178809		1-	A	D1
C 1617	CHIP CAP.	0.001uF	50V	B	GRM155B11H102KA01D	K22178809		1-	B	b2
C 1618	CHIP CAP.	0.001uF	50V	B	GRM155B11H102KA01D	K22178809		1-	A	C3
C 1619	CHIP CAP.	0.047uF	25V	B	GRM188B11E473KA01D	K22144811		1-	A	C3
C 1620	CHIP CAP.	1uF	25V	B	GRM21BB31E105KA98L	K22140826		1-	A	C3
C 1621	CHIP CAP.	0.001uF	50V	B	GRM155B11H102KA01D	K22178809		1-	B	d3
C 1622	CHIP CAP.	0.1uF	10V	B	GRM155B11A104KA01D	K22108802		1-	B	d3
C 1623	CHIP CAP.	47pF	50V	CH	GRM1552C1H470GA01D	K22179709		1-	A	C3
C 1624	CHIP CAP.	39pF	50V	CH	GRM1552C1H390GA01D	K22179703		1-	A	C3
C 1625	CHIP CAP.	82pF	50V	CH	GRM1552C1H820GA01D	K22179725		1-	A	C3
C 1626	CHIP CAP.	5pF	50V	CH	GRM1552C1H5R0BA01D	K22178292		1-	A	C3
C 1627	CHIP CAP.	12pF	50V	CH	GRM1552C1H120GA01D	K22179723		1-	A	C3
C 1628	CHIP CAP.	0.047uF	25V	B	GRM188B11E473KA01D	K22144811		1-	A	D3
C 1629	CHIP CAP.	33pF	50V	CH	GRM1552C1H330GA01D	K22179708		1-	A	C3
C 1630	CHIP CAP.	1uF	25V	B	GRM21BB31E105KA98L	K22140826		1-	A	D3
C 1631	CHIP CAP.	0.001uF	50V	B	GRM155B11H102KA01D	K22178809		1-	A	D3
C 1632	CHIP CAP.	0.01uF	25V	B	GRM155B11E103KA01D	K22148834		1-	A	D3
C 1633	CHIP CAP.	0.001uF	50V	B	GRM155B11H102KA01D	K22178809		1-	B	d3
C 1634	CHIP CAP.	7pF	50V	CH	GRM1552C1H7R0BA01D	K22178294		1-	A	C3
C 1635	CHIP CAP.	15pF	50V	CH	GRM1552C1H150GA01D	K22178300		1-	A	C4
C 1636	CHIP CAP.	22pF	50V	CH	GRM1552C1H220GA01D	K22179707		1-	A	D3
C 1637	CHIP CAP.	0.01uF	25V	B	GRM155B11E103KA01D	K22148834		1-	B	e2
C 1638	CHIP CAP.	10uF	25V	B	GRM31CB31E106KA75L	K22141815		1-	A	B1
C 1639	CHIP CAP.	0.001uF	50V	B	GRM155B11H102KA01D	K22178809		1-	B	e2
C 1640	CHIP CAP.	0.001uF	50V	B	GRM155B11H102KA01D	K22178809		1-	B	c4
C 1641	CHIP CAP.	7pF	50V	CH	GRM1552C1H7R0BA01D	K22178294		1-	B	d4
C 1642	CHIP CAP.	100pF	50V	CH	GRM1552C1H101JA01D	K22178236		1-	B	d4
C 1643	CHIP CAP.	0.001uF	50V	B	GRM155B11H102KA01D	K22178809		1-	B	d3
C 1644	CHIP CAP.	0.01uF	25V	B	GRM155B11E103KA01D	K22148834		1-	B	d3
C 1646	CHIP CAP.	0.001uF	50V	B	GRM155B11H102KA01D	K22178809		1-	B	d3

MAIN Unit

Parts List

REF	DESCRIPTION	VALUE	V/W	TOL.	MFR'S DESIG	YAESU P/N	VERS.	LOT	SIDE	LAY ADR
C 1647	CHIP CAP.	0.001uF	50V	B	GRM155B11H102KA01D	K22178809		1-	B	d3
C 1648	CHIP CAP.	1uF	6.3V	B	GRM155B30J105KE18D	K22088803		1-	B	d3
C 1649	CHIP CAP.	0.001uF	50V	B	GRM155B11H102KA01D	K22178809		1-	B	d3
C 1650	CHIP CAP.	0.1uF	10V	B	GRM155B11A104KA01D	K22108802		1-	B	c3
C 1651	CHIP CAP.	0.01uF	25V	B	GRM155B11E103KA01D	K22148834		1-	B	c3
C 1652	CHIP CAP.	0.001uF	50V	B	GRM155B11H102KA01D	K22178809		1-	B	c3
C 1653	CHIP CAP.	0.001uF	50V	B	GRM155B11H102KA01D	K22178809		1-	B	d4
C 1654	CHIP TA.CAP.	10uF	10V		TAJA106M010Y	K78100072		1-	B	c3
C 1654	CHIP TA.CAP.	10uF	10V		TAJA106M010RNJ	K78100120		26-	B	c3
C 1655	CHIP CAP.	0.001uF	50V	B	GRM155B11H102KA01D	K22178809		1-	A	B3
C 1656	CHIP CAP.	0.001uF	50V	B	GRM155B11H102KA01D	K22178809		1-	B	e3
C 1657	CHIP CAP.	0.001uF	50V	B	GRM155B11H102KA01D	K22178809		1-	B	d4
C 1709	CHIP CAP.	0.001uF	50V	B	GRM155B11H102KA01D	K22178809		1-	A	D4
C 1710	CHIP CAP.	0.001uF	50V	B	GRM155B11H102KA01D	K22178809		1-	A	D4
C 1711	CHIP CAP.	3pF	50V	CJ	GRM1553C1H3R0BA01D	K22178290		1-	A	D4
C 1712	CHIP CAP.	0.001uF	50V	B	GRM155B11H102KA01D	K22178809		1-	A	D4
C 1713	CHIP CAP.	0.001uF	50V	B	GRM155B11H102KA01D	K22178809		1-	B	c4
C 1715	CHIP CAP.	1pF	50V	CK	GRM1554C1H1R0BA01D	K22178287		1-	B	c4
C 1716	CHIP CAP.	12pF	50V	CH	GRM1552C1H120GA01D	K22179723		1-	B	c4
C 1717	CHIP CAP.	18pF	50V	CH	GRM1552C1H180GA01D	K22179701		1-	B	c4
C 1718	CHIP CAP.	0.001uF	50V	B	GRM188B11H102KA01D	K22174821		1-	B	c4
C 1719	CHIP CAP.	12pF	50V	CH	GRM1552C1H120GA01D	K22179723		1-	B	c4
C 1720	CHIP CAP.	0.001uF	50V	B	GRM155B11H102KA01D	K22178809		1-	B	c4
C 1721	CHIP CAP.	0.001uF	50V	B	GRM155B11H102KA01D	K22178809		1-	B	c4
C 1722	CHIP CAP.	0.001uF	50V	B	GRM155B11H102KA01D	K22178809		1-	B	c5
C 1723	CHIP CAP.	2pF	50V	CK	GRM1554C1H2R0BA01D	K22178289		1-	A	D4
C 1724	CHIP CAP.	0.001uF	50V	B	GRM155B11H102KA01D	K22178809		1-	B	c4
C 1726	CHIP CAP.	2pF	50V	CK	GRM1554C1H2R0BA01D	K22178289		1-	B	d4
C 1727	CHIP CAP.	18pF	50V	CH	GRM1552C1H180GA01D	K22179701		1-	B	d4
C 1728	CHIP CAP.	20pF	50V	CH	GRM1552C1H200GA01	K22179702		1-	B	d4
C 1729	CHIP CAP.	0.001uF	50V	B	GRM188B11H102KA01D	K22174821		1-	B	d4
C 1730	CHIP CAP.	0.001uF	50V	B	GRM155B11H102KA01D	K22178809		1-	B	d4
C 1732	CHIP CAP.	0.001uF	50V	B	GRM155B11H102KA01D	K22178809		1-	B	d4
C 1733	CHIP CAP.	20pF	50V	CH	GRM1552C1H200GA01	K22179702		1-	B	d4
C 1734	CHIP CAP.	0.001uF	50V	B	GRM155B11H102KA01D	K22178809		1-	B	d5
C 1735	CHIP CAP.	0.001uF	50V	B	GRM155B11H102KA01D	K22178809		1-	A	C4
C 1737	CHIP TA.CAP.	0.1uF	20V		TMCP1D104MTRF	K78130049		1-	A	D4
C 1738	CHIP TA.CAP.	3.3uF	16V		TMCMA1C335MTRF	K78120021		1-	A	D4
C 1739	CHIP TA.CAP.	6.8uF	16V		TMCMA1C685MTRF	K78120056		1-	A	D4
C 1740	CHIP CAP.	0.22uF	10V	B	GRM155B31A224KE18D	K22108808		1-	A	D4
C 1741	CHIP CAP.	100pF	50V	CH	GRM1552C1H101JA01D	K22178236		1-	A	D4
C 1742	CHIP CAP.	0.1uF	10V	B	GRM155B11A104KA01D	K22108802		1-	A	D4
C 1743	CHIP TA.CAP.	0.1uF	20V		TMCP1D104MTRF	K78130049		1-	A	D5
C 1744	CHIP CAP.	22pF	50V	CH	GRM1552C1H220JA01D	K22178220		1-	A	D5
C 1745	CHIP CAP.	22pF	50V	CH	GRM1552C1H220JA01D	K22178220		1-	A	D5
C 1746	CHIP CAP.	22pF	50V	CH	GRM1552C1H220JA01D	K22178220		1-	A	D5
C 1747	CHIP CAP.	22pF	50V	CH	GRM1552C1H220JA01D	K22178220		1-	A	D4
C 1748	CHIP CAP.	0.001uF	50V	B	GRM155B11H102KA01D	K22178809		1-	B	c5
C 1749	CHIP CAP.	0.01uF	25V	B	GRM155B11E103KA01D	K22148834		1-	B	c5
C 1750	CHIP CAP.	0.1uF	10V	B	GRM155B11A104KA01D	K22108802		1-	B	c5
C 1751	CHIP CAP.	0.001uF	50V	B	GRM155B11H102KA01D	K22178809		1-	A	D5
C 1752	CHIP CAP.	2.2uF	10V	B	GRM188B31A225KE18D	K22104805		1-	B	c5
C 1753	CHIP CAP.	47pF	50V	CH	GRM1552C1H470JA01D	K22178228		1-	B	c5
C 1754	CHIP CAP.	3pF	50V	CJ	GRM1553C1H3R0BA01D	K22178290		1-	B	c5
C 1755	CHIP CAP.	4pF	50V	CH	GRM1552C1H4R0BA01D	K22178291		1-	B	d5
C 1757	CHIP CAP.	0.001uF	50V	B	GRM155B11H102KA01D	K22178809		1-	A	D4
C 1758	CHIP TA.CAP.	10uF	10V		TMCP1A106MTRF	K78100074		1-	A	D4
C 1760	CHIP CAP.	0.01uF	25V	B	GRM155B11E103KA01D	K22148834		1-	A	D4
C 1761	CHIP CAP.	1uF	10V	F	GRM188F11A105ZA01D	K22105001		1-	A	D4
C 1762	CHIP CAP.	0.047uF	10V	B	GRM155B11A473KA01D	K22108801		1-	A	D5
C 1763	CHIP CAP.	0.01uF	25V	B	GRM155B11E103KA01D	K22148834		1-	B	c5
C 1764	CHIP CAP.	1uF	10V	F	GRM188F11A105ZA01D	K22105001		1-	A	D4
C 1765	CHIP CAP.	0.01uF	25V	B	GRM155B11E103KA01D	K22148834		1-	B	c5
C 1766	CHIP CAP.	4.7uF	6.3V	B	C1608X5R0J475KT	K22084805		1-	A	C4
C 1767	CHIP CAP.	1uF	6.3V	B	GRM155B30J105KE18D	K22088803		1-	B	f5
C 1768	CHIP CAP.	22pF	50V	CH	GRM1552C1H220GA01D	K22179707		1-	B	f5
C 1769	CHIP TA.CAP.	47uF	4V		TMCMA0G476MTRF	K78060048		1-	B	f5
C 1770	CHIP CAP.	1uF	6.3V	B	GRM155B30J105KE18D	K22088803		1-	B	f4
C 1771	CHIP TA.CAP.	22uF	10V		TCSM1A226M8R	K78100124		1-	A	B5
C 1772	CHIP CAP.	0.0056uF	25V	B	GRM155B11E562KA01D	K22148802		1-	B	f5
C 1773	CHIP CAP.	0.0068uF	25V	B	GRM155B11E682KA01D	K22148803		1-	B	f5
C 1774	CHIP CAP.	0.0056uF	25V	B	GRM155B11E562KA01D	K22148802		1-	B	f5
C 1775	CHIP CAP.	0.0068uF	25V	B	GRM155B11E682KA01D	K22148803		1-	B	f5

MAIN Unit

Parts List

REF	DESCRIPTION	VALUE	V/W	TOL.	MFR'S DESIG	YAESU P/N	VERS.	LOT	SIDE	LAY ADR
C 1776	CHIP CAP.	470pF	50V	CH	GRM1882C1H471JA01D	K22174249		1-	B	f5
C 1777	CHIP CAP.	10pF	50V	CH	GRM1552C1H100BA01D	K22178297		1-	B	f5
C 1778	CHIP CAP.	0.001uF	50V	B	GRM155B11H102KA01D	K22178809		1-	B	f4
C 1779	CHIP TA.CAP.	10uF	10V		TAJA106M010Y	K78100072		1-	B	e5
C 1779	CHIP TA.CAP.	10uF	10V		TAJA106M010RNJ	K78100120		26-	B	e5
C 1780	CHIP CAP.	0.022uF	16V	B	GRM155B11C223KA01D	K22128806		1-	B	e5
C 1781	CHIP CAP.	0.1uF	10V	B	GRM155B11A104KA01D	K22108802		1-	B	e5
C 1782	CHIP CAP.	0.1uF	10V	B	GRM155B11A104KA01D	K22108802		1-	B	e5
C 1783	CHIP CAP.	0.1uF	10V	B	GRM155B11A104KA01D	K22108802		1-	B	f5
C 1784	CHIP TA.CAP.	10uF	10V		TAJA106M010Y	K78100072		1-	B	f5
C 1784	CHIP TA.CAP.	10uF	10V		TAJA106M010RNJ	K78100120		26-	B	f5
C 1785	CHIP CAP.	100pF	50V	CH	GRM1552C1H101JA01D	K22178236		1-	B	e5
C 1786	CHIP CAP.	0.1uF	10V	B	GRM155B11A104KA01D	K22108802		1-	B	f5
C 1787	CHIP CAP.	33pF	50V	CH	GRM1552C1H330GA01D	K22179708		1-	B	f5
C 1788	CHIP TA.CAP.	10uF	10V		TAJA106M010Y	K78100072		1-	B	f4
C 1788	CHIP TA.CAP.	10uF	10V		TAJA106M010RNJ	K78100120		26-	B	f4
C 1789	CHIP CAP.	0.001uF	50V	B	GRM155B11H102KA01D	K22178809		1-	B	f5
C 1790	CHIP TA.CAP.	47uF	4V		TMCMA0G476MTRF	K78060048		1-	B	f4
C 1791	CHIP CAP.	0.0047uF	50V	B	GRM155B11H472KA01D	K22178838		1-	B	f5
C 1792	CHIP TA.CAP.	22uF	6.3V		TMCMA0J226MTRF	K78080047		1-	A	C5
C 1793	CHIP CAP.	0.001uF	50V	B	GRM155B11H102KA01D	K22178809		1-	A	C4
C 1794	CHIP CAP.	0.001uF	50V	B	GRM155B11H102KA01D	K22178809		1-	A	C4
C 1795	CHIP CAP.	0.1uF	10V	B	GRM155B11A104KA01D	K22108802		1-	A	B4
C 1796	CHIP CAP.	0.1uF	10V	B	GRM155B11A104KA01D	K22108802		1-	A	B3
C 1797	CHIP CAP.	5pF	50V	CH	GRM1552C1H5R0BA01D	K22178292		1-	A	E6
C 1798	CHIP CAP.	0.001uF	50V	B	GRM155B11H102KA01D	K22178809		1-	B	b5
C 1800	CHIP TA.CAP.	10uF	10V		TAJA106M010Y	K78100072		1-	A	D5
C 1800	CHIP TA.CAP.	10uF	10V		TAJA106M010RNJ	K78100120		26-	A	D5
C 1801	CHIP CAP.	0.001uF	50V	B	GRM155B11H102KA01D	K22178809		1-	B	d5
C 1804	CHIP CAP.	0.001uF	50V	B	GRM155B11H102KA01D	K22178809		1-	A	C4
C 1805	CHIP TA.CAP.	47uF	6.3V		TMCMA0J476MTRF	K78080085		1-	A	C4
C 1806	CHIP CAP.	0.01uF	25V	B	GRM155B11E103KA01D	K22148834		1-	B	f6
C 1807	CHIP CAP.	7pF	50V	CH	GRM1552C1H7R0BA01D	K22178294		1-	B	f6
C 1808	CHIP CAP.	0.001uF	50V	B	GRM155B11H102KA01D	K22178809		1-	B	g5
C 1809	CHIP CAP.	0.001uF	50V	B	GRM155B11H102KA01D	K22178809		1-	B	g4
C 1810	CHIP CAP.	0.001uF	50V	B	GRM155B11H102KA01D	K22178809		1-	B	f4
C 1811	CHIP TA.CAP.	22uF	6.3V		TMCMA0J226MTRF	K78080047		1-	B	g4
C 1812	CHIP CAP.	0.1uF	10V	B	GRM155B11A104KA01D	K22108802		1-	B	f4
C 1813	CHIP CAP.	0.1uF	10V	B	GRM155B11A104KA01D	K22108802		1-	B	g5
C 1814	CHIP CAP.	0.001uF	50V	B	GRM155B11H102KA01D	K22178809		1-	B	g4
C 1815	AL.ELECTRO.CAP.	100uF	16V		EEE1CA101WP	K48120012		1-	A	B3
C 1816	CHIP TA.CAP.	100uF	4V		TMCMA0G107MTRF	K78060051		1-	A	F6
C 1817	CHIP TA.CAP.	100uF	4V		TMCMA0G107MTRF	K78060051		1-	A	E6
C 1818	AL.ELECTRO.CAP.	220uF	16V		RV-16V221MG10-R	K48120015		1-	A	D6
C 1820	CHIP CAP.	0.1uF	10V	B	GRM155B11A104KA01D	K22108802		1-	A	E6
C 1821	CHIP CAP.	0.01uF	25V	B	GRM155B11E103KA01D	K22148834		1-	A	E6
C 1822	CHIP CAP.	0.001uF	50V	B	GRM155B11H102KA01D	K22178809		1-	B	e6
C 1823	CHIP CAP.	0.001uF	50V	B	GRM155B11H102KA01D	K22178809		1-	B	e6
C 1824	CHIP CAP.	0.001uF	50V	B	GRM155B11H102KA01D	K22178809		1-	B	e6
C 1825	CHIP CAP.	0.001uF	50V	B	GRM155B11H102KA01D	K22178809		1-	B	e6
C 1826	CHIP CAP.	0.001uF	50V	B	GRM155B11H102KA01D	K22178809		1-	B	e6
C 1827	CHIP CAP.	100pF	50V	CH	GRM1552C1H101JA01D	K22178236		1-	B	e6
C 1828	CHIP CAP.	0.001uF	50V	B	GRM155B11H102KA01D	K22178809		1-	B	e6
C 1829	CHIP CAP.	0.1uF	10V	B	GRM155B11A104KA01D	K22108802		1-	B	d6
C 1830	CHIP CAP.	0.1uF	10V	B	GRM155B11A104KA01D	K22108802		1-	B	d6
C 1831	CHIP CAP.	0.001uF	50V	B	GRM155B11H102KA01D	K22178809		1-	B	e6
C 1832	CHIP CAP.	0.001uF	50V	B	GRM155B11H102KA01D	K22178809		1-	B	d5
C 1833	CHIP CAP.	470pF	50V	B	GRM155B11H471KA01D	K22178805		1-	B	d6
C 1834	CHIP TA.CAP.	10uF	10V		TAJA106M010Y	K78100072		1-	A	D6
C 1834	CHIP TA.CAP.	10uF	10V		TAJA106M010RNJ	K78100120		26-	A	D6
C 1835	CHIP CAP.	0.022uF	16V	B	GRM155B11C223KA01D	K22128806		1-	B	d6
C 1836	CHIP TA.CAP.	10uF	10V		TAJA106M010Y	K78100072		1-	B	d6
C 1836	CHIP TA.CAP.	10uF	10V		TAJA106M010RNJ	K78100120		26-	B	d6
C 1837	CHIP CAP.	0.022uF	16V	B	GRM155B11C223KA01D	K22128806		1-	B	d6
C 1838	CHIP CAP.	0.01uF	25V	B	GRM155B11E103KA01D	K22148834		1-	B	d6
C 1839	CHIP CAP.	15pF	50V	CH	GRM1552C1H150GA01D	K22178300		1-	B	d6
C 1840	CHIP CAP.	0.1uF	10V	B	GRM155B11A104KA01D	K22108802		1-	A	C2
C 1841	CHIP CAP.	0.1uF	10V	B	GRM155B11A104KA01D	K22108802		1-	B	e2
C 1842	CHIP CAP.	0.1uF	10V	B	GRM155B11A104KA01D	K22108802		1-	B	e2
C 1843	CHIP CAP.	0.1uF	10V	B	GRM155B11A104KA01D	K22108802		1-	B	e2
C 1844	CHIP CAP.	0.1uF	10V	B	GRM155B11A104KA01D	K22108802		1-	B	e2
C 1845	CHIP CAP.	47pF	50V	CH	GRM1552C1H470JA01D	K22178228		1-	A	B2
C 1846	CHIP CAP.	47pF	50V	CH	GRM1552C1H470JA01D	K22178228		1-	A	A2

MAIN Unit

Parts List

REF	DESCRIPTION	VALUE	V/W	TOL.	MFR'S DESIG	YAESU P/N	VERS.	LOT	SIDE	LAY ADR
C 1847	CHIP CAP.	47pF	50V	CH	GRM1552C1H470JA01D	K22178228		1-	A	A2
C 1848	CHIP CAP.	47pF	50V	CH	GRM1552C1H470JA01D	K22178228		1-	A	A2
C 1849	CHIP CAP.	47pF	50V	CH	GRM1552C1H470JA01D	K22178228		1-	A	A1
C 1850	CHIP CAP.	47pF	50V	CH	GRM1552C1H470JA01D	K22178228		1-	A	B2
C 1851	CHIP CAP.	47pF	50V	CH	GRM1552C1H470JA01D	K22178228		1-	A	B2
C 1852	CHIP CAP.	47pF	50V	CH	GRM1552C1H470JA01D	K22178228		1-	A	B1
C 1853	CHIP TA.CAP.	22uF	16V		TMCMB1C226MTRF	K78120028		1-	B	e3
C 1853	CHIP CAP.	22uF	25V	X5R	GRM21BR61E226ME44L	K22140830		3-	B	e3
C 1854	CHIP CAP.	0.001uF	50V	B	GRM155B11H102KA01D	K22178809		1-	B	e3
C 1855	CHIP CAP.	47pF	50V	CH	GRM1552C1H470JA01D	K22178228		1-	B	e2
C 1856	CHIP CAP.	0.1uF	10V	B	GRM155B11A104KA01D	K22108802		1-	B	e4
C 1857	CHIP CAP.	0.001uF	50V	B	GRM155B11H102KA01D	K22178809		1-	B	e3
C 1858	CHIP TA.CAP.	47uF	6.3V		TMCMA0J476MTRF	K78080085		1-	B	e3
C 1859	CHIP CAP.	0.1uF	16V	B	GRM188B11C104KA01D	K22124805		1-	B	e3
C 1860	AL.ELECTRO.CAP.	100uF	16V		EEE1CA101WP	K48120012		1-	B	e2
C 1861	CHIP CAP.	0.001uF	50V	B	GRM155B11H102KA01D	K22178809		1-	A	B2
C 1862	CHIP CAP.	0.001uF	50V	B	GRM155B11H102KA01D	K22178809		1-	A	A2
C 1863	CHIP CAP.	0.001uF	50V	B	GRM155B11H102KA01D	K22178809		1-	A	B2
C 1864	CHIP CAP.	0.001uF	50V	B	GRM155B11H102KA01D	K22178809		1-	B	e1
C 1865	AL.ELECTRO.CAP.	2200uF	16V		RJ5-16V222M	K40129101		1-	B	f2
C 1866	CHIP CAP.	0.001uF	50V	B	GRM155B11H102KA01D	K22178809		1-	B	e2
C 1867	CHIP TA.CAP.	47uF	6.3V		TMCMA0J476MTRF	K78080085		1-	B	e2
C 1868	CHIP CAP.	0.1uF	16V	B	GRM188B11C104KA01D	K22124805		1-	B	e2
C 1869	CHIP CAP.	0.1uF	10V	B	GRM155B11A104KA01D	K22108802		1-	B	f4
C 1870	CHIP CAP.	0.001uF	50V	B	GRM155B11H102KA01D	K22178809		1-	A	A4
C 1871	CHIP CAP.	0.1uF	10V	B	GRM155B11A104KA01D	K22108802		1-	A	A5
C 1872	CHIP CAP.	2pF	50V	CK	GRM1554C1H2R0BA01D	K22178289		1-	B	f5
C 1873	CHIP CAP.	0.001uF	50V	B	GRM155B11H102KA01D	K22178809		1-	B	f5
C 1874	CHIP CAP.	18pF	50V	CH	GRM1552C1H180JA01D	K22178218		1-	A	A5
C 1875	CHIP CAP.	20pF	50V	CH	GRM1552C1H200JA01D	K22178219		1-	B	f5
C 1876	CHIP CAP.	0.001uF	50V	B	GRM155B11H102KA01D	K22178809		1-	B	f5
C 1877	CHIP TA.CAP.	10uF	10V		TAJA106M010Y	K78100072		1-	B	f5
C 1877	CHIP TA.CAP.	10uF	10V		TAJA106M010RNJ	K78100120		26-	B	f5
C 1878	CHIP CAP.	0.001uF	50V	B	GRM155B11H102KA01D	K22178809		1-	A	B5
C 1879	CHIP CAP.	4.7uF	6.3V	B	C-1608X5R0J475KT	K22084805		1-	B	f4
C 1880	CHIP CAP.	0.0012uF	50V	CH	GRM1882C1H122JA01D	K22174276		1-	B	e4
C 1881	CHIP CAP.	0.01uF	25V	B	GRM155B11E103KA01D	K22148834		1-	A	C5
C 1883	CHIP CAP.	0.001uF	50V	B	GRM155B11H102KA01D	K22178809		1-	A	F3
C 1884	CHIP CAP.	7pF	200V	CH	GRM1882C2D7R0DV01D	K22234209		1	B	b2
C 1884	CHIP CAP.	7pF	250V	C0G	GQM1875C2E7R0DB12D	K22244218		2-	B	b2
C 1885	CHIP CAP.	0.5pF	200V	CK	GRM1884C2DR50CY21D	K22234201		1	A	E2
C 1885	CHIP CAP.	0.5pF	250V	C0G	GQM1875C2ER50CB12D	K22244202		2-	A	E2
C 1892	CHIP CAP.	0.0022uF	50V	B	GRM155B11H222KA01D	K22178813		1-	A	C4
C 1893	CHIP CAP.	7pF	50V	CH	GRM1552C1H7R0BA01D	K22178294		1-	B	c4
C 1952	CHIP CAP.	0.047uF	10V	B	GRM155B11A473KA01D	K22108801		1-	B	d4
C 1953	CHIP CAP.	0.01uF	25V	B	GRM155B11E103KA01D	K22148834		1-	B	e5
C 1954	CHIP CAP.	0.5pF	50V	CK	GRM1554C1HR50BA01D	K22178285		1-	B	b5
C 1956	CHIP CAP.	0.001uF	50V	B	GRM155B11H102KA01D	K22178809		1-	A	D3
C 1957	CHIP CAP.	0.001uF	50V	B	GRM155B11H102KA01D	K22178809		1-	B	c3
C 1958	CHIP CAP.	0.01uF	25V	B	GRM155B11E103KA01D	K22148834		1-	B	e5
C 1959	CHIP CAP.	0.001uF	50V	B	GRM155B11H102KA01D	K22178809		1-	B	c3
C 1960	CHIP CAP.	39pF	50V	CH	GRM1552C1H390GA01D	K22179703		1-	B	d4
C 1961	CHIP CAP.	1pF	50V	CK	GRM1554C1H1R0BA01D	K22178287		1-	A	E4
C 1962	CHIP CAP.	0.001uF	50V	B	GRM155B11H102KA01D	K22178809		1-	B	d3
CD1001	CERAMIC DISC				JTBM450CX24	H7901530		1-	B	d5
CF1001	CERAMIC FILTER				LTM450FW3.5-002-AD	H3900590		1-	A	D5
CF1002	CERAMIC FILTER				LTWC450E	H3900565		1-	B	e5
D 1001	DIODE				1SS390	G2071226		1-	B	a2
D 1002	DIODE				RN142S TE61	G2070994		1-	B	b3
D 1003	DIODE				1SS390	G2071226		1-	B	b3
D 1004	DIODE				1SV305(TPH3)	G2070942		1-	B	b4
D 1005	DIODE				1SV305(TPH3)	G2070942		1-	B	b4
D 1006	DIODE				1SV305(TPH3)	G2070942		1-	B	b4
D 1007	DIODE				RN142S TE61	G2070994		1-	A	E4
D 1008	DIODE				RN141S TE61	G2071546		1-	A	E4
D 1016	DIODE				1SV323(TPH3.F)	G2071006		1-	B	b4
D 1017	DIODE				1SV323(TPH3.F)	G2071006		1-	B	b4
D 1018	DIODE				1SV323(TPH3.F)	G2071006		1-	B	b4
D 1019	DIODE				RN141S TE61	G2071546		1-	A	D4
D 1020	DIODE				RN141S TE61	G2071546		1-	B	a4
D 1025	DIODE				RN142S TE61	G2070994		1-	A	D4
D 1027	DIODE				RN141S TE61	G2071546		1-	B	a2
D 1028	DIODE				1SS400 TE61	G2070634		1-	A	F4

MAIN Unit

Parts List

REF	DESCRIPTION	VALUE	V/W	TOL.	MFR'S DESIG	YAESU P/N	VERS.	LOT	SIDE	LAY ADR
D 1030	DIODE				BB145B	G2071507		1-	A	E4
D 1031	DIODE				BB145B	G2071507		1-	A	E4
D 1032	DIODE				BB145B	G2071507		1-	A	E4
D 1033	DIODE				RN142S TE61	G2070994		1-	A	E4
D 1038	DIODE				RN141S TE61	G2071546		1-	A	D4
D 1039	DIODE				RN141S TE61	G2071546		1-	B	c4
D 1040	DIODE				1SS400 TE61	G2070634		1-	B	d4
D 1041	DIODE				1SS400 TE61	G2070634		1-	B	d5
D 1042	DIODE				1SS400 TE61	G2070634		1-	B	d5
D 1043	DIODE				1SS400G T2R	G2070934		1-	B	d5
D 1044	DIODE				1SS400G T2R	G2070934		1-	B	d5
D 1052	DIODE				MC2850-T111-1	G2070704		1-	A	C5
D 1053	DIODE				MC2850-T111-1	G2070704		1-	B	e5
D 1054	DIODE				DAN222 TL	G2070174		1-	A	C4
D 1055	DIODE				DA221 TL	G2070178		1-	B	e4
D 1497	DIODE				1SS400 TE61	G2070634		1-	B	b3
D 1498	DIODE				JDP2S12CR	G2071416		1-	B	e2
D 1501	DIODE				1SS400 TE61	G2070634		1-	A	F3
D 1502	DIODE				DB2S31400L	G2071348		1-	A	E2
D 1503	DIODE				DB2S31400L	G2071348		1-	B	b2
D 1504	DIODE				1SS400 TE61	G2070634		1-	B	b1
D 1505	SURGE ABSORBER				RHCA-301Q43U	Q9000827		1-	B	a1
D 1506	DIODE				1SS400 TE61	G2070634		1-	A	F3
D 1507	DIODE				DB2S31400L	G2071348		1-	A	F3
D 1508	DIODE				DB2S31400L	G2071348		1-	B	b3
D 1509	DIODE				RLS135 TE-11	G2070128		1-	A	C2
D 1510	DIODE				RN141S TE61	G2071546		1-	A	D4
D 1511	DIODE				UDZS TE-17 6.8B	G2070888		1-	A	C3
D 1512	DIODE				1SS390	G2071226		1-	A	D4
D 1513	DIODE				1SS390	G2071226		1-	B	d4
D 1514	DIODE				1SS390	G2071226		1-	A	D4
D 1515	DIODE				1SS400 TE61	G2070634		1-	B	c3
D 1516	DIODE				DAN222 TL	G2070174		1-	B	c4
D 1529	DIODE				BBY57-02V	G2071548		1-	B	c4
D 1530	DIODE				BBY57-02V	G2071548		1-	B	c4
D 1531	DIODE				1SS390	G2071226		1-	B	c4
D 1532	DIODE				1SS390	G2071226		1-	A	D4
D 1533	DIODE				1SS390	G2071226		1-	A	D4
D 1534	DIODE				1SS390	G2071226		1-	B	d4
D 1536	DIODE				1SV323(TPH3.F)	G2071006		1-	B	d4
D 1537	DIODE				DA221 TL	G2070178		1-	A	D4
D 1542	DIODE				1SS390	G2071226		1-	B	f4
D 1543	DIODE				1SS390	G2071226		1-	B	f4
D 1544	DIODE				DAN222 TL	G2070174		1-	B	f4
D 1546	DIODE				1SS400 TE61	G2070634		1-	B	f5
D 1548	DIODE				1SS400 TE61	G2070634		1-	B	f4
D 1549	DIODE				1SS400 TE61	G2070634		1-	B	f4
D 1550	DIODE				1SS400 TE61	G2070634		1-	B	f4
D 1551	DIODE				1SS400 TE61	G2070634		1-	B	f4
D 1552	DIODE				1SS400 TE61	G2070634		1-	A	B3
D 1553	DIODE				EDZV T2R 5.1B	G2070998		1-	B	e6
D 1554	DIODE				EDZV T2R 5.1B	G2070998		1-	B	e6
D 1555	DIODE				DF2S5.1FS,L3M(T	G2071494		1-	B	e6
D 1556	DIODE				EDZV T2R 5.1B	G2070998		1-	B	e6
D 1557	DIODE				DF2S5.1FS,L3M(T	G2071494		1-	B	f6
D 1558	DIODE				EDZV T2R 5.1B	G2070998		1-	A	A1
D 1559	DIODE				EDZV T2R 5.1B	G2070998		1-	A	B1
D 1560	DIODE				EDZV T2R 5.1B	G2070998		1-	A	B2
D 1561	SURGE ABSORBER				P6KA18A-HE3	Q9000721A		1-	A	C1
D 1561	SURGE ABSORBER				P6KE18AHE3/54	Q9001010		21-	A	C1
D 1562	DIODE				RB751G-40T2R	G2071066		1-	A	A4
D 1564	DIODE				EDZV T2R 5.1B	G2070998		1-	A	B1
D 1565	DIODE				1SS400 TE61	G2070634		1-	B	e3
D 1566	DIODE				1SS400 TE61	G2070634		1-	B	c3
D 1567	DIODE				1SS400 TE61	G2070634		1-	B	c3
F 1501	CHIP FUSE	1A			FCC10 102ABTP	Q0000120		1-	B	e6
FB1001	FERRITE BEADS				BLM15AG121SN1D	L1690843		1-	A	A2
FB1002	FERRITE BEADS				BLM15AG121SN1D	L1690843		1-	A	A2
FB1003	CHIP COIL				BLM21PG300SN1D	L1690840		1-	A	A2
FB1004	CHIP COIL				BLM21PG300SN1D	L1690840		1-	B	f1
FB1005	CHIP COIL				BLM21PG300SN1D	L1690840		1-	B	g1
FB1501	FERRITE BEADS				BLM15AG121SN1D	L1690843		1-	B	b2
FB1502	FERRITE BEADS				SMB304729	L9190094		1-	A	C1

MAIN Unit

Parts List

REF	DESCRIPTION	VALUE	V/W	TOL.	MFR'S DESIG	YAESU P/N	VERS.	LOT	SIDE	LAY ADR
FB1503	CHIP COIL				BLM21PG300SN1D	L1690840		1-	A	B3
FB1504	FERRITE BEADS				BLM15AG121SN1D	L1690843		1-	A	B2
FB1505	FERRITE BEADS				BLM15AG121SN1D	L1690843		1-	B	e2
FB1506	CHIP COIL				BLM21PG300SN1D	L1690840		1-	A	D3
FB1507	FERRITE BEADS				BLM15AG121SN1D	L1690843		1-	B	e6
FB1508	FERRITE BEADS				BLM15AG121SN1D	L1690843		1-	B	e6
FB1509	FERRITE BEADS				BLM15AG121SN1D	L1690843		1-	B	d6
FB1510	FERRITE BEADS				BLM15AG121SN1D	L1690843		1-	B	d6
FB1511	FERRITE BEADS				BLM15AG121SN1D	L1690843		1-	B	e6
FB1512	FERRITE BEADS				BLM15AG121SN1D	L1690843		1-	B	e6
FB1513	FERRITE BEADS				BLM15AG121SN1D	L1690843		1-	B	e6
FB1514	FERRITE BEADS				BLM15AG121SN1D	L1690843		1-	B	e6
FB1515	FERRITE BEADS				BLM15AG121SN1D	L1690843		1-	B	e6
FB1516	FERRITE BEADS				BLM15AG121SN1D	L1690843		1-	B	f6
FB1517	FERRITE BEADS				BLM15AG121SN1D	L1690843		1-	A	B2
FB1518	FERRITE BEADS				BLM15AG121SN1D	L1690843		1-	A	B2
FB1519	FERRITE BEADS				BLM15AG121SN1D	L1690843		1-	A	A2
FB1520	FERRITE BEADS				BLM15AG121SN1D	L1690843		1-	A	A2
FB1521	FERRITE BEADS				BLM15AG121SN1D	L1690843		1-	A	A1
FB1522	FERRITE BEADS				BLM15AG121SN1D	L1690843		1-	A	A1
FB1523	FERRITE BEADS				BLM15AG121SN1D	L1690843		1-	A	B2
FB1524	FERRITE BEADS				BLM15AG121SN1D	L1690843		1-	A	B2
FB1525	FERRITE BEADS				BLM15AG121SN1D	L1690843		1-	A	B2
FB1526	FERRITE BEADS				BLM15AG121SN1D	L1690843		1-	A	B2
FB1527	FERRITE BEADS				SMB304729	L9190094		1-	A	A2
FB1528	FERRITE BEADS				SMB304729	L9190094		1-	A	B2
FB1529	FERRITE BEADS				SMB304729	L9190094		1-	A	A2
FB1530	FERRITE BEADS				BLM15AG121SN1D	L1690843		1-	A	A1
HS1501	HEATSINK PLATE					RA022760A		1-	B	d3
J 1001	CONNECTOR				502570-0893	P1091471		1-	B	b6
J 1002	CONNECTOR				AXK6S40435J	P0091415		1-	A	A4
J 1002	CONNECTOR				AXK6S40437YG	P0091509		26-	A	A4
J 1003	CONNECTOR				BM02B-SRSS-TBT(LF)(SN)	P0091465		1-	A	A2
J 1004	CONNECTOR				PJ3027K-K	P1091500		1-	A	A1
J 1004	CONNECTOR				TSH-3865	P1091622		14-	A	A1
J 1501	CONNECTOR				B2B-ZR(LF)(SN)	P0090647		1-	A	B2
J 1502	CONNECTOR				AXK6F24547YG	P0091557		1-	A	B4
J 1503	CONNECTOR				AXK6S40637YG	P0091323		1-	A	E6
J 1504	CONNECTOR				MJV0404KX06	P1091430		1-	A	C6
J 1505	CONNECTOR				MJV0606KX06-H	P1091386		1-	A	B6
J 1506	CONNECTOR				TCS7705-5120177	P1091244		1-	B	f1
J 1507	TERMINAL				NC-0.5-3.2-T	S5000327		1-	A	C4
L 1001	CHIP COIL	0.01uH		2%	LQW18AN10NG00D	L1690880		1-	B	a2
L 1002	CHIP COIL	0.043uH		2%	LQW18AN43NG00D	L1691784		1-	B	a3
L 1003	M.RFC	0.01uH		2%	LL1005-FHL10NG	L1691797		1-	B	b3
L 1004	CHIP COIL	0.1uH		2%	LQW18ANR10G00D	L1690892		1-	B	b4
L 1005	CHIP COIL	0.01uH		2%	LQW18AN10NG00D	L1690880		1-	B	b4
L 1006	COIL				E2 0.28-1.0-4T-R	L0022365		1-	B	b4
L 1007	COIL				E2 0.28-1.0-4T-R	L0022365		1-	B	b4
L 1008	M.RFC	0.015uH			LL1608-FSL15NJ	L1690863		1-	B	b4
L 1009	M.RFC	0.015uH			LL1608-FSL15NJ	L1690863		1-	B	b4
L 1010	M.RFC	0.015uH			LL1608-FSL15NJ	L1690863		1-	A	E4
L 1012	M.RFC	0.1uH			LL1608-FSLR10J	L1691748		1-	B	a3
L 1022	CHIP COIL	0.056uH		2%	LQW18AN56NG00D	L1690889		1-	B	a3
L 1023	CHIP COIL	0.1uH		2%	LQW18ANR10G00D	L1690892		1-	B	a3
L 1024	CHIP COIL	0.047uH		2%	LQW18AN47NG00D	L1690888		1-	B	a4
L 1025	CHIP COIL	0.22uH		2%	LQW18ANR22G00D	L1690896		1-	B	a4
L 1026	M.RFC	1uH			LK1608 1R0K-T	L1690687		1-	B	b4
L 1027	CHIP COIL	0.082uH		2%	LQW18AN82NG00D	L1690891		1-	B	b4
L 1028	CHIP COIL	0.082uH		2%	LQW18AN82NG00D	L1690891		1-	B	b4
L 1029	CHIP COIL	0.082uH		2%	LQW18AN82NG00D	L1690891		1-	B	b4
L 1030	M.RFC	0.047uH			LL1608-FSL47NJ	L1690367		1-	A	E4
L 1036	CHIP COIL	0.082uH		2%	LQW18AN82NG00D	L1690891		1-	B	a3
L 1037	CHIP COIL	0.022uH		2%	LQW18AN22NG00D	L1690884		1-	A	F3
L 1038	CHIP COIL	0.022uH		2%	LQW18AN22NG00D	L1690884		1-	A	F4
L 1039	CHIP COIL	0.082uH		2%	LQW18AN82NG00D	L1690891		1-	A	F4
L 1040	M.RFC	0.1uH			LL1608-FSLR10J	L1691748		1-	A	F4
L 1041	CHIP COIL	0.047uH		2%	LQW18AN47NG00D	L1690888		1-	A	E4
L 1042	CHIP COIL	0.047uH		2%	LQW18AN47NG00D	L1690888		1-	A	E4
L 1043	M.RFC	0.068uH			LL1608-FSL68NJ	L1690871		1-	A	E4
L 1047	COIL				E2 0.3-1.1-3T-R	L0022579		1-	A	F2
L 1048	M.RFC	0.0082uH			LL1608-FSL8N2J	L1691573		1-	B	a2
L 1049	M.RFC	0.0082uH			LL1608-FSL8N2J	L1691573		1-	B	a2

MAIN Unit

Parts List

REF	DESCRIPTION	VALUE	V/W	TOL.	MFR'S DESIG	YAESU P/N	VERS.	LOT	SIDE	LAY ADR
L 1050	CHIP COIL	0.012uH		2%	LQW18AN12NG00D	L1690881		1-	B	a2
L 1051	M.RFC	0.0056uH			LL1608-FSL5N6S	L1690858		1-	B	a3
L 1052	M.RFC	0.0056uH			LL1608-FSL5N6S	L1690858		1-	B	a3
L 1053	M.RFC	0.0039uH			LL1608-FSL3N9S	L1691752		1-	A	E4
L 1054	M.RFC	0.0039uH			LL1608-FSL3N9S	L1691752		1-	A	E4
L 1055	M.RFC	0.0056uH			LL1608-FSL5N6S	L1690858		1-	A	E4
L 1056	M.RFC	0.01uH			LL1608-FSL10NJ	L1690861		1-	A	E4
L 1062	CHIP COIL	0.39uH		2%	LQW18ANR39G00D	L1691786		1-	B	c4
L 1063	CHIP COIL	0.39uH		2%	LQW18ANR39G00D	L1691786		1-	B	d4
L 1064	CHIP COIL	0.39uH		2%	LQW18ANR39G00D	L1691786		1-	B	d5
L 1068	M.RFC	1uH			LK1608 1R0K-T	L1690687		1-	B	e4
L 1069	CHIP COIL	0.12uH		2%	LQW18ANR12G00D	L1690893		1-	B	a4
L 1501	COIL	0.01uH			AS100340-10R4NJ	L0023194		1-	B	a1
L 1502	COIL	0.015uH			AS100440-15RONJ	L0023196		1-	A	F2
L 1503	COIL	0.015uH			AS100440-15RONJ	L0023196		1-	A	F2
L 1504	COIL	0.01uH			AS100340-10R4NJ	L0023194		1-	A	E3
L 1505	M.RFC	0.47uH			LK1608 R47K-T	L1690414		1-	A	E2
L 1506	COIL	0.0093uH			AS120252-9R3N	L0022853		1-	A	E2
L 1507	COIL	0.047uH			AS100747-47N	L0022548		1-	A	G2
L 1508	CHIP COIL	0.047uH		2%	LQW18AN47NG00D	L1690888		1-	B	a3
L 1509	COIL	0.033uH			AS100547-33N	L0022546		1-	A	G3
L 1510	M.RFC	0.47uH			LK1608 R47K-T	L1690414		1-	A	F3
L 1511	M.RFC	1uH			LK1608 1R0K-T	L1690687		1-	B	c3
L 1512	COIL	0.033uH			AS100547-33N	L0022546		1-	A	E3
L 1513	COIL	0.033uH			AS100547-33N	L0022546		1-	A	E3
L 1514	COIL	0.033uH			AS100547-33N	L0022546		1-	A	E3
L 1515	COIL A1				1.5T3.0D1.2UEW R	L0022806		1-	A	D3
L 1516	COIL				E2 0.35-1.6-4T-L	L0022456		1-	A	C3
L 1518	COIL	0.0033uH			ASs050221-3R3NJ	L0022825		1-	A	C3
L 1519	CHIP COIL	1uH		5%	LQW21HN1R0J00L	L1691864		1-	B	e3
L 1520	COIL	0.012uH			AS080336-12N	L0022810		1-	A	C2
L 1521	COIL	0.047uH			AS100747-47N	L0022548		1-	A	D1
L 1522	COIL	0.056uH			ASs050635-56R0NJ	L0022813		1-	A	C3
L 1523	COIL				E2 0.28-1.0-4.5T-R	L0022395		1-	A	C3
L 1524	COIL				E2 0.3-0.9-3T-R	L0022389		1-	A	C3
L 1525	CHIP COIL	0.1uH		2%	LQW18ANR10G00D	L1690892		1-	A	D3
L 1526	COIL				E2 0.3-1.1-3T-R	L0022579		1-	A	C3
L 1527	M.RFC	0.01uH			LL1608-FSL10NJ	L1690861		1-	A	C4
L 1528	M.RFC	0.01uH			LL1608-FSL10NJ	L1690861		1-	B	c4
L 1529	M.RFC	0.047uH			LL1608-FSL47NJ	L1690367		1-	B	d4
L 1530	M.RFC	1uH			LK1608 1R0K-T	L1690687		1-	A	B3
L 1543	CHIP COIL	0.39uH		2%	LQW18ANR39G00D	L1691786		1-	A	D4
L 1544	M.RFC	0.022uH			LL1608-FSL22NJ	L1690865		1-	B	c4
L 1545	CHIP COIL	0.39uH		2%	LQW18ANR39G00D	L1691786		1-	A	D4
L 1546	CHIP COIL	0.0087uH		2%	LQW18AN8N7G80D	L1691862		1-	B	c4
L 1547	CHIP COIL	0.0056uH			LQW18AN5N6C00D	L1691450		1-	B	c4
L 1548	M.RFC	1uH			LK1608 1R0K-T	L1690687		1-	B	c4
L 1549	M.RFC	0.15uH			LK1608 R15K-T	L1690409		1-	B	d4
L 1550	CHIP COIL	0.027uH		2%	LQW18AN27NG00D	L1690885		1-	B	d4
L 1551	CHIP COIL	0.39uH		2%	LQW18ANR39G00D	L1691786		1-	A	C5
L 1552	CHIP COIL	0.027uH		2%	LQW18AN27NG00D	L1690885		1-	B	d4
L 1553	M.RFC	4.7uH			LK1608 4R7K-T	L1690688		1-	B	d4
L 1554	CHIP COIL	0.39uH		2%	LQW18ANR39G00D	L1691786		1-	A	D5
L 1555	M.RFC	0.1uH			LL1608-FSLR10J	L1691748		1-	B	d4
L 1556	M.RFC	1uH			LK1608 1R0K-T	L1690687		1-	A	E6
L 1557	M.RFC	1uH			LK1608 1R0K-T	L1690687		1-	B	f5
L 1558	M.RFC	1uH			LK1608 1R0K-T	L1690687		1-	B	e6
L 1559	M.RFC	1uH			LK1608 1R0K-T	L1690687		1-	B	d6
L 1560	M.RFC	6.8uH		2%	KQ1008TTE6R8G	L1691214		1-	B	f5
L 1561	M.RFC	0.47uH			LK1608 R47K-T	L1690414		1-	A	F2
L 1562	M.RFC	1uH			LK1608 1R0K-T	L1690687		1-	B	c5
L 1563	M.RFC	1uH			LK1608 1R0K-T	L1690687		1-	B	c4
L 1564	M.RFC	1uH			LK1608 1R0K-T	L1690687		1-	B	c3
L 1565	M.RFC	1uH			LK1608 1R0K-T	L1690687		1-	B	d3
L 1566	M.RFC	1uH			LK1608 1R0K-T	L1690687		1-	A	D3
L 1567	M.RFC	1uH			LK1608 1R0K-T	L1690687		1-	B	e3
Q 1001	FET				3SK293(TE85L.F)	G4802938A		1-	B	a3
Q 1002	FET				3SK293(TE85L.F)	G4802938A		1-	B	c4
Q 1003	TRANSISTOR				2SC5006-T1-A/YFB	G3350068		1-	B	c4
Q 1007	FET				3SK293(TE85L.F)	G4802938A		1-	B	a4
Q 1008	FET				3SK293(TE85L.F)	G4802938A		1-	B	c4
Q 1011	FET				3SK293(TE85L.F)	G4802938A		1-	A	F4
Q 1012	TRANSISTOR				2SC5006-T1-A/YFB	G3350068		1-	A	E4

MAIN Unit

Parts List

REF	DESCRIPTION	VALUE	V/W	TOL.	MFR'S DESIG	YAESU P/N	VERS.	LOT	SIDE	LAY ADR
Q 1013	TRANSISTOR				DTC144EE TL	G3070075		1-	A	E4
Q 1017	TRANSISTOR				2SC5277-D2-TL	G3352778B		1-	B	a2
Q 1018	TRANSISTOR				2SC5006-T1-A/YFB	G3350068		1-	B	a3
Q 1019	TRANSISTOR				2SC5006-T1-A/YFB	G3350068		1-	A	E4
Q 1022	IC				NJM2370U33-TE1	G1094564		1-	A	C6
Q 1024	TRANSISTOR				2SC5006-T1-A/YFB	G3350068		1-	A	D4
Q 1025	TRANSISTOR				DTC144EE TL	G3070075		1-	A	C4
Q 1026	TRANSISTOR				2SC4617 TL R	G3346178R		1-	A	C4
Q 1027	TRANSISTOR				2SC4915-O(TE85L.F)	G3349158O		1-	B	d5
Q 1028	IC				NJM2552V-TE1	G1094382		1-	B	d5
Q 1030	TRANSISTOR				DTC144EE TL	G3070075		1-	A	C5
Q 1031	TRANSISTOR				UMD5N TR	G3070343		1-	B	d6
Q 1040	TRANSISTOR				2SC4617 TL R	G3346178R		1-	A	C5
Q 1041	TRANSISTOR				DTC144EE TL	G3070075		1-	B	e4
Q 1042	TRANSISTOR				DTC144EE TL	G3070075		1-	B	e4
Q 1043	IC				R2S15207FP	G1094955		1-	A	B3
Q 1045	TRANSISTOR				2SC4617 TL R	G3346178R		1-	B	e4
Q 1047	TRANSISTOR				2SC4617 TL R	G3346178R		1-	A	B3
Q 1049	FET				2SK397300L	G3839738		1	A	A3
Q 1049	FET				RUM002N02T2L	G3070455		2-	A	A3
Q 1051	FET				2SK397300L	G3839738		1	B	f3
Q 1051	FET				RUM002N02T2L	G3070455		2-	B	f3
Q 1052	IC				TDA1519CTH	G1093778		1-	B	f3
Q 1053	TRANSISTOR				2SC4617 TL R	G3346178R		1-	B	g3
Q 1054	TRANSISTOR				DTC144EE TL	G3070075		1-	B	f3
Q 1059	IC				SN74LV4053APWR	G1093870		1-	A	C4
Q 1060	TRANSISTOR				DTC144EE TL	G3070075		1-	B	e5
Q 1100	IC				LM2904PWR	G1094010		1-	A	E5
Q 1102	IC				LM2904PWR	G1094010		1-	B	d6
Q 1105	IC				LM2902PWR	G1094009		1-	B	e4
Q 1106	IC				LM2902PWR	G1094009		1-	B	d4
Q 1120	IC				LM2904PWR	G1094010		1-	A	E5
Q 1122	IC				LM2902PWR	G1094009		1-	B	e5
Q 1142	IC				LM2902PWR	G1094009		1-	B	f5
Q 1501	TRANSISTOR				DTC143EE TL	G3070114		1-	B	b3
Q 1502	TRANSISTOR				DTC143EE TL	G3070114		1-	B	b3
Q 1503	TRANSISTOR				DTC143EE TL	G3070114		1-	B	c3
Q 1504	FET				RD70HUF2	G3090157		1-	A	D2
Q 1505	FET				RD07MVS1-T12	G3070320		1-	A	C3
Q 1505	FET				RD07MVS1-T232	G3070508		10-	A	C3
Q 1506	FET				RQA0004PXDQS	G3070391		1-	A	C4
Q 1507	TRANSISTOR				2SC4617 TL R	G3346178R		1-	A	A1
Q 1508	TRANSISTOR				UMD5N TR	G3070343		1-	B	c3
Q 1509	TRANSISTOR				EMD30(T2R)	G3070427		1-	B	d4
Q 1510	TRANSISTOR				EMD30(T2R)	G3070427		1-	B	d4
Q 1512	IC				LM2904PWR	G1094010		1-	B	c3
Q 1522	TRANSISTOR				2SC5006-T1-A/YFB	G3350068		1-	A	D4
Q 1523	TRANSISTOR				2SC5006-T1-A/YFB	G3350068		1-	A	D4
Q 1524	TRANSISTOR				2SC5006-T1-A/YFB	G3350068		1-	B	c4
Q 1525	TRANSISTOR				2SC5006-T1-A/YFB	G3350068		1-	B	c4
Q 1526	TRANSISTOR				2SC5006-T1-A/YFB	G3350068		1-	A	D4
Q 1527	TRANSISTOR				2SC5006-T1-A/YFB	G3350068		1-	B	d4
Q 1528	TRANSISTOR				2SC5006-T1-A/YFB	G3350068		1-	B	d4
Q 1529	TRANSISTOR				DTC144EE TL	G3070075		1-	A	D4
Q 1530	TRANSISTOR				DTC144EE TL	G3070075		1-	A	D4
Q 1531	IC				MB15A01PFV1-G-BND-EFE1	G1092545		1-	A	D5
Q 1532	TRANSISTOR				2SA1774 TL R	G3117748R		1-	A	D5
Q 1533	TRANSISTOR				2SC4617 TL R	G3346178R		1-	A	D4
Q 1535	IC				CMX589AD5	G1094597		1-	B	f5
Q 1536	IC				SN74LV4053APWR	G1093870		1-	B	f5
Q 1537	IC				CMX865AE4	G1094617		1-	B	e5
Q 1538	TRANSISTOR				2SC4617 TL R	G3346178R		1-	A	B3
Q 1539	IC				R2A20178NP	G1094776		1-	A	C4
Q 1543	TRANSISTOR				DTC144EE TL	G3070075		1-	A	C5
Q 1544	TRANSISTOR				UMA8N TR	G3070270		1-	A	C4
Q 1546	TRANSISTOR				UMD5N TR	G3070343		1-	A	D5
Q 1547	TRANSISTOR				DTC144EE TL	G3070075		1-	A	C5
Q 1551	TRANSISTOR				2SC4617 TL R	G3346178R		1-	A	D5
Q 1553	TRANSISTOR				UMA8N TR	G3070270		1-	A	F5
Q 1554	TRANSISTOR				UMA8N TR	G3070270		1-	A	F5
Q 1555	TRANSISTOR				UMD5N TR	G3070343		1-	A	F5
Q 1556	IC				S-35190A-T8T1G	G1094356		1-	B	f6
Q 1557	IC				NJM2370U33-TE1	G1094564		1-	B	g4

MAIN Unit

Parts List

REF	DESCRIPTION	VALUE	V/W	TOL.	MFR'S DESIG	YAESU P/N	VERS.	LOT	SIDE	LAY ADR
Q 1558	TRANSISTOR				2SC4617 TL R	G3346178R		1-	B	g5
Q 1559	IC				S-80835CNMC-B8U-T2-G	G1093606		1-	B	g4
Q 1560	IC				NJM2370U33-TE1	G1094564		1-	A	E6
Q 1561	IC				TC7W53FU(TE12L_F)	G1094158		1-	B	d6
Q 1562	IC				ADM3202ARUZ	G1094022		1-	B	e2
Q 1563	TRANSISTOR				DTC144EE TL	G3070075		1-	A	B4
Q 1564	IC				BA09CC0FP-BZE2	G1094432		1-	B	e3
Q 1565	IC				NJM2370U33-TE1	G1094564		1-	B	e3
Q 1566	TRANSISTOR				DTC143EE TL	G3070114		1-	A	B3
Q 1567	TRANSISTOR				2SB1301-T2 ZQ/ZP	G3213017Q		1-	A	B2
Q 1568	IC				NJM78L05UA-TE1	G1091325		1-	B	e2
Q 1569	TRANSISTOR				2SC4617 TL R	G3346178R		1-	B	f5
Q 1570	IC				S-24CM01CI-J8T1U4	*		1-	B	f6
Q 1571	IC				R4F24279NVFQU	G1094898		1-	A	A5
Q 1574	IC				TC7S66FU(TE85R.F)	G1092116		1-	A	A1
Q 1575	IC				TC7S66FU(TE85R.F)	G1092116		1-	A	A2
Q 1576	TRANSISTOR				EMD12 T2R	G3070341		1-	A	A4
Q 1577	TRANSISTOR				2SA2029 T2L Q/R	G3120298		1-	B	e5
Q 1578	TRANSISTOR				DTC144EM T2L	G3070309		1-	A	B4
Q 1579	TRANSISTOR				EMD12 T2R	G3070341		1-	B	e5
Q 1580	IC				NJM2831F03-TE1	G1094902		1-	B	c5
Q 1581	TRANSISTOR				DTA144EE TL	G3070074		1-	A	A1
Q 1582	TRANSISTOR				DTC144EE TL	G3070075		1-	B	g3
Q 1906	TRANSISTOR				DTC144EE TL	G3070075		1-	A	C4
Q 1907	TRANSISTOR				2SC4617 TL R	G3346178R		1-	A	A4
Q 1908	TRANSISTOR				2SA1774 TL R	G3117748R		1-	B	c3
Q 1909	TRANSISTOR				DTC144EE TL	G3070075		1-	B	c4
Q 1915	IC				TC7S66FU(TE85R.F)	G1092116		1-	B	f6
Q 1916	IC				TC7S66FU(TE85R.F)	G1092116		1-	B	f6
Q 1917	TRANSISTOR				DTC144EE TL	G3070075		1-	A	E5
Q 1918	TRANSISTOR				DTC144EE TL	G3070075		1-	A	E5
Q 1919	TRANSISTOR				DTC144EE TL	G3070075		1-	A	E5
Q 1920	TRANSISTOR				DTC144EE TL	G3070075		1-	A	E5
R 1001	CHIP RES.	39k	1/16W	5%	RMC1/16S 393JTH	J24189044		1-	B	a3
R 1002	CHIP RES.	27	1/16W	5%	RMC1/16S 270JTH	J24189006		1-	B	a3
R 1004	CHIP RES.	10	1/16W	5%	RMC1/16S 100JTH	J24189001		1-	B	b3
R 1006	CHIP RES.	100	1/16W	5%	RMC1/16S 101JTH	J24189013		1-	B	b4
R 1007	CHIP RES.	100k	1/16W	5%	RMC1/16S 104JTH	J24189049		1-	B	b4
R 1008	CHIP RES.	100k	1/16W	5%	RMC1/16S 104JTH	J24189049		1-	B	b4
R 1009	CHIP RES.	100k	1/16W	5%	RMC1/16S 104JTH	J24189049		1-	B	b4
R 1010	CHIP RES.	220k	1/16W	5%	RMC1/16S 224JTH	J24189053		1-	B	b4
R 1011	CHIP RES.	220k	1/16W	5%	RMC1/16S 224JTH	J24189053		1-	B	b4
R 1012	CHIP RES.	56k	1/16W	5%	RMC1/16S 563JTH	J24189046		1-	B	b4
R 1013	CHIP RES.	47k	1/16W	5%	RMC1/16S 473JTH	J24189045		1-	B	b4
R 1014	CHIP RES.	150	1/16W	5%	RMC1/16S 151JTH	J24189015		1-	B	c4
R 1015	CHIP RES.	4.7k	1/16W	5%	RMC1/16S 472JTH	J24189033		1-	B	b4
R 1016	CHIP RES.	47k	1/16W	5%	RMC1/16S 473JTH	J24189045		1-	B	b3
R 1017	CHIP RES.	100	1/16W	5%	RMC1/16S 101JTH	J24189013		1-	B	b4
R 1018	CHIP RES.	1M	1/16W	5%	RMC1/16S 105JTH	J24189061		1-	B	b4
R 1019	CHIP RES.	1k	1/16W	5%	RMC1/16S 102JTH	J24189025		1-	B	b3
R 1020	CHIP RES.	100	1/16W	5%	RMC1/16S 101JTH	J24189013		1-	B	b4
R 1021	CHIP RES.	1.5k	1/16W	5%	RMC1/16S 152JTH	J24189027		1-	A	E4
R 1022	CHIP RES.	180	1/16W	5%	RMC1/16S 181JTH	J24189016		1-	B	c4
R 1023	CHIP RES.	4.7k	1/16W	5%	RMC1/16S 472JTH	J24189033		1-	B	a2
R 1024	CHIP RES.	100k	1/16W	5%	RMC1/16S 104JTH	J24189049		1-	B	a3
R 1026	CHIP RES.	220k	1/16W	5%	RMC1/16S 224JTH	J24189053		1-	B	a3
R 1040	CHIP RES.	100k	1/16W	5%	RMC1/16S 104JTH	J24189049		1-	B	a4
R 1049	CHIP RES.	56k	1/16W	5%	RMC1/16S 563JTH	J24189046		1-	B	a4
R 1050	CHIP RES.	10k	1/16W	5%	RMC1/16S 103JTH	J24189037		1-	B	a4
R 1051	CHIP RES.	27	1/16W	5%	RMC1/16S 270JTH	J24189006		1-	B	a4
R 1052	CHIP RES.	47	1/16W	5%	RMC1/16S 470JTH	J24189009		1-	B	b4
R 1053	CHIP RES.	4.7k	1/16W	5%	RMC1/16S 472JTH	J24189033		1-	B	b4
R 1054	CHIP RES.	100	1/16W	5%	RMC1/16S 101JTH	J24189013		1-	B	b4
R 1055	CHIP RES.	220k	1/16W	5%	RMC1/16S 224JTH	J24189053		1-	B	b4
R 1056	CHIP RES.	220k	1/16W	5%	RMC1/16S 224JTH	J24189053		1-	B	b4
R 1057	CHIP RES.	220k	1/16W	5%	RMC1/16S 224JTH	J24189053		1-	B	b4
R 1058	CHIP RES.	15k	1/16W	5%	RMC1/16S 153JTH	J24189039		1-	B	c4
R 1059	CHIP RES.	47k	1/16W	5%	RMC1/16S 473JTH	J24189045		1-	B	c4
R 1060	CHIP RES.	120k	1/16W	5%	RMC1/16S 124JTH	J24189050		1-	B	b4
R 1061	CHIP RES.	220k	1/16W	5%	RMC1/16S 224JTH	J24189053		1-	B	b4
R 1062	CHIP RES.	150	1/16W	5%	RMC1/16S 151JTH	J24189015		1-	B	c4
R 1063	CHIP RES.	1.8k	1/16W	5%	RMC1/16S 182JTH	J24189028		1-	A	E4
R 1066	CHIP RES.	4.7k	1/16W	5%	RMC1/16S 472JTH	J24189033		1-	B	a3

* Please Contact YAESU when replacing this part.

MAIN Unit

Parts List

REF	DESCRIPTION	VALUE	V/W	TOL.	MFR'S DESIG	YAESU P/N	VERS.	LOT	SIDE	LAY ADR
R 1079	CHIP RES.	100	1/16W	5%	RMC1/16S 101JTH	J24189013		1-	B	a2
R 1080	CHIP RES.	470k	1/16W	5%	RMC1/16S 474JTH	J24189057		1-	A	F4
R 1081	CHIP RES.	100k	1/16W	5%	RMC1/16S 104JTH	J24189049		1-	A	F4
R 1082	CHIP RES.	47k	1/16W	5%	RMC1/16S 473JTH	J24189045		1-	A	F4
R 1083	CHIP RES.	47	1/16W	5%	RMC1/16S 470JTH	J24189009		1-	A	F4
R 1084	CHIP RES.	47	1/16W	5%	RMC1/16S 470JTH	J24189009		1-	A	F4
R 1085	CHIP RES.	470	1/16W	5%	RMC1/16S 471JTH	J24189021		1-	A	E4
R 1086	CHIP RES.	100	1/16W	5%	RMC1/16S 101JTH	J24189013		1-	A	E4
R 1087	CHIP RES.	1M	1/16W	5%	RMC1/16S 105JTH	J24189061		1-	A	E4
R 1088	CHIP RES.	470	1/16W	5%	RMC1/16S 471JTH	J24189021		1-	A	E4
R 1089	CHIP RES.	6.8k	1/16W	5%	RMC1/16S 682JTH	J24189035		1-	A	E4
R 1090	CHIP RES.	47k	1/16W	5%	RMC1/16S 473JTH	J24189045		1-	A	F4
R 1099	CHIP RES.	100	1/16W	5%	RMC1/16S 101JTH	J24189013		1-	B	a2
R 1100	CHIP RES.	4.7k	1/16W	5%	RMC1/16S 472JTH	J24189033		1-	B	a2
R 1101	CHIP RES.	330k	1/16W	5%	RMC1/16S 334JTH	J24189055		1-	B	a2
R 1102	CHIP RES.	100	1/16W	5%	RMC1/16S 101JTH	J24189013		1-	B	a3
R 1103	CHIP RES.	68	1/16W	5%	RMC1/16S 680JTH	J24189011		1-	B	a2
R 1104	CHIP RES.	0	1/16W	5%	RMC1/16S JPTH	J24189070		1-	B	a3
R 1105	CHIP RES.	820k	1/16W	5%	RMC1/16S 824JTH	J24189060		1-	B	a3
R 1106	CHIP RES.	1k	1/16W	5%	RMC1/16S 102JTH	J24189025		1-	A	F4
R 1108	CHIP RES.	100	1/16W	5%	RMC1/16S 101JTH	J24189013		1-	A	E4
R 1109	CHIP RES.	47k	1/16W	5%	RMC1/16S 473JTH	J24189045		1-	A	E4
R 1110	CHIP RES.	1k	1/16W	5%	RMC1/16S 102JTH	J24189025		1-	A	E4
R 1111	CHIP RES.	100k	1/16W	5%	RMC1/16S 104JTH	J24189049		1-	A	E4
R 1112	CHIP RES.	100k	1/16W	5%	RMC1/16S 104JTH	J24189049		1-	A	E4
R 1113	CHIP RES.	100k	1/16W	5%	RMC1/16S 104JTH	J24189049		1-	A	E4
R 1114	CHIP RES.	820k	1/16W	5%	RMC1/16S 824JTH	J24189060		1-	A	E4
R 1115	CHIP RES.	100	1/16W	5%	RMC1/16S 101JTH	J24189013		1-	A	E4
R 1116	CHIP RES.	330	1/16W	5%	RMC1/16S 331JTH	J24189019		1-	A	E4
R 1130	CHIP RES.	1k	1/16W	5%	RMC1/16S 102JTH	J24189025		1-	A	E5
R 1132	CHIP RES.	100k	1/16W	5%	RMC1/16S 104JTH	J24189049		1-	A	E6
R 1133	CHIP RES.	0	1/16W	5%	RMC1/16S JPTH	J24189070		1-	B	b6
R 1134	CHIP RES.	0	1/16W	5%	RMC1/16S JPTH	J24189070		1-	A	E6
R 1135	CHIP RES.	0	1/16W	5%	RMC1/16S JPTH	J24189070		1-	A	E6
R 1136	CHIP RES.	0	1/16W	5%	RMC1/16S JPTH	J24189070		1-	A	E6
R 1137	CHIP RES.	0	1/16W	5%	RMC1/16S JPTH	J24189070		1-	A	E6
R 1138	CHIP RES.	100k	1/16W	5%	RMC1/16S 104JTH	J24189049		1-	A	E6
R 1139	CHIP RES.	100k	1/16W	5%	RMC1/16S 104JTH	J24189049		1-	A	E6
R 1140	CHIP RES.	100k	1/16W	5%	RMC1/16S 104JTH	J24189049		1-	A	E6
R 1141	CHIP RES.	100k	1/16W	5%	RMC1/16S 104JTH	J24189049		1-	B	b6
R 1143	CHIP RES.	0	1/16W	5%	RMC1/16S JPTH	J24189070		1-	B	b6
R 1144	CHIP RES.	390	1/16W	5%	RMC1/16S 391JTH	J24189020		1-	A	C6
R 1145	CHIP RES.	390	1/16W	5%	RMC1/16S 391JTH	J24189020		1-	A	C6
R 1146	CHIP RES.	390	1/16W	5%	RMC1/16S 391JTH	J24189020		1-	A	C6
R 1147	CHIP RES.	390	1/16W	5%	RMC1/16S 391JTH	J24189020		1-	A	C6
R 1148	CHIP RES.	390	1/16W	5%	RMC1/16S 391JTH	J24189020		1-	A	C6
R 1149	CHIP RES.	390	1/16W	5%	RMC1/16S 391JTH	J24189020		1-	A	C6
R 1151	CHIP RES.	330k	1/16W	5%	RMC1/16S 334JTH	J24189055		1-	A	B6
R 1154	CHIP RES.	1.8k	1/16W	5%	RMC1/16S 182JTH	J24189028		1-	B	c4
R 1155	CHIP RES.	0	1/16W	5%	RMC1/16S JPTH	J24189070		1-	B	c4
R 1156	CHIP RES.	100	1/16W	5%	RMC1/16S 101JTH	J24189013		1-	B	c4
R 1157	CHIP RES.	560	1/16W	5%	RMC1/16S 561JTH	J24189022		1-	A	D4
R 1158	CHIP RES.	22	1/16W	5%	RMC1/16S 220JTH	J24189005		1-	A	C4
R 1159	CHIP RES.	330k	1/16W	5%	RMC1/16S 334JTH	J24189055		1-	A	D4
R 1160	CHIP RES.	330	1/16W	5%	RMC1/16S 331JTH	J24189019		1-	A	D4
R 1161	CHIP RES.	330	1/16W	5%	RMC1/16S 331JTH	J24189019		1-	B	d4
R 1162	CHIP RES.	100	1/16W	5%	RMC1/16S 101JTH	J24189013		1-	B	d4
R 1163	CHIP RES.	10k	1/16W	5%	RMC1/16S 101JTH	J24189013		1-	B	d4
R 1165	CHIP RES.	100	1/16W	5%	RR0510P-103-D	J24189143		1-	B	b4
R 1166	CHIP RES.	100	1/16W	5%	RMC1/16S 101JTH	J24189013		1-	A	C4
R 1167	CHIP RES.	100k	1/16W	5%	RMC1/16S 104JTH	J24189049		1-	A	C4
R 1168	CHIP RES.	1M	1/16W	5%	RMC1/16S 105JTH	J24189061		1-	B	d5
R 1169	CHIP RES.	100k	1/16W	5%	RMC1/16S 104JTH	J24189049		1-	B	d5
R 1170	CHIP RES.	2.2k	1/16W	5%	RMC1/16S 222JTH	J24189029		1-	B	d5
R 1171	CHIP RES.	1k	1/16W	5%	RMC1/16S 102JTH	J24189025		1-	B	d5
R 1172	CHIP RES.	100	1/16W	5%	RMC1/16S 101JTH	J24189013		1-	B	d5
R 1173	CHIP RES.	22k	1/16W	5%	RMC1/16S 223JTH	J24189041		1-	B	d5
R 1174	CHIP RES.	6.8k	1/16W	5%	RMC1/16S 682JTH	J24189035		1-	B	d5
R 1175	CHIP RES.	150k	1/16W	5%	RMC1/16S 154JTH	J24189051		1-	B	d5
R 1176	CHIP RES.	4.7k	1/16W	5%	RMC1/16S 472JTH	J24189033		1-	A	C5
R 1177	CHIP RES.	150k	1/16W	5%	RMC1/16S 154JTH	J24189051		1-	A	C5
R 1178	CHIP RES.	2.2k	1/16W	5%	RMC1/16S 222JTH	J24189029		1-	A	C5
R 1179	CHIP RES.	100	1/16W	5%	RMC1/16S 101JTH	J24189013		1-	B	d5
R 1181	CHIP RES.	4.7k	1/16W	5%	RMC1/16S 472JTH	J24189033		1-	A	C5

MAIN Unit

Parts List

REF	DESCRIPTION	VALUE	V/W	TOL.	MFR'S DESIG	YAESU P/N	VERS.	LOT	SIDE	LAY ADR
R 1182	CHIP RES.	220	1/16W	5%	RMC1/16S 221JTH	J24189017		1-	B	d5
R 1183	CHIP RES.	4.7k	1/16W	5%	RMC1/16S 472JTH	J24189033		1-	B	d5
R 1184	CHIP RES.	22k	1/16W	5%	RMC1/16S 223JTH	J24189041		1-	B	d5
R 1185	CHIP RES.	22k	1/16W	5%	RMC1/16S 223JTH	J24189041		1-	B	d5
R 1186	CHIP RES.	22k	1/16W	5%	RMC1/16S 223JTH	J24189041		1-	B	d5
R 1187	CHIP RES.	22k	1/16W	5%	RMC1/16S 223JTH	J24189041		1-	B	d5
R 1188	CHIP RES.	22k	1/16W	5%	RMC1/16S 223JTH	J24189041		1-	B	d5
R 1189	CHIP RES.	22k	1/16W	5%	RMC1/16S 223JTH	J24189041		1-	B	d5
R 1192	CHIP RES.	1.8k	1/16W	5%	RMC1/16S 182JTH	J24189028		1-	A	C5
R 1193	CHIP RES.	47	1/16W	5%	RMC1/16S 470JTH	J24189009		1-	A	C5
R 1235	CHIP RES.	4.7k	1/16W	5%	RMC1/16S 472JTH	J24189033		1-	A	E5
R 1236	CHIP RES.	10k	1/16W	5%	RMC1/16S 103JTH	J24189037		1-	A	E5
R 1237	CHIP RES.	150k	1/16W	0.5%	MCR01MZPD1503	J24189328		1-	A	E5
R 1239	CHIP RES.	10k	1/16W	5%	RMC1/16S 103JTH	J24189037		1-	A	E5
R 1240	CHIP RES.	100k	1/16W	0.5%	RR0510R-104-D	J24189167		1-	A	E5
R 1241	CHIP RES.	100k	1/16W	5%	RMC1/16S 104JTH	J24189049		1-	A	C5
R 1242	CHIP RES.	560	1/16W	5%	RMC1/16S 561JTH	J24189022		1-	A	C5
R 1243	CHIP RES.	3.3k	1/16W	5%	RMC1/16S 332JTH	J24189031		1-	A	C5
R 1244	CHIP RES.	100k	1/16W	5%	RMC1/16S 104JTH	J24189049		1-	A	C5
R 1245	CHIP RES.	3.3k	1/16W	5%	RMC1/16S 332JTH	J24189031		1-	A	C5
R 1246	CHIP RES.	100k	1/16W	5%	RMC1/16S 104JTH	J24189049		1-	B	e5
R 1247	CHIP RES.	330k	1/16W	5%	RMC1/16S 334JTH	J24189055		1-	A	B5
R 1248	CHIP RES.	330k	1/16W	5%	RMC1/16S 334JTH	J24189055		1-	A	B5
R 1249	CHIP RES.	150k	1/16W	5%	RMC1/16S 154JTH	J24189051		1-	A	C5
R 1250	CHIP RES.	8.2k	1/16W	5%	RMC1/16S 822JTH	J24189036		1-	A	C5
R 1251	CHIP RES.	470k	1/16W	5%	RMC1/16S 474JTH	J24189057		1-	A	C5
R 1253	CHIP RES.	330k	1/16W	5%	RMC1/16S 334JTH	J24189055		1-	A	C4
R 1254	CHIP RES.	47k	1/16W	5%	RMC1/16S 473JTH	J24189045		1-	A	C4
R 1255	CHIP RES.	150k	1/16W	5%	RMC1/16S 154JTH	J24189051		1-	B	d4
R 1256	CHIP RES.	22k	1/16W	5%	RMC1/16S 223JTH	J24189041		1-	B	d4
R 1257	CHIP RES.	10k	1/16W	5%	RMC1/16S 103JTH	J24189037		1-	B	d4
R 1258	CHIP RES.	22k	1/16W	5%	RMC1/16S 223JTH	J24189041		1-	B	d4
R 1259	CHIP RES.	6.8k	1/16W	5%	RMC1/16S 682JTH	J24189035		1-	B	d4
R 1260	CHIP RES.	33k	1/16W	5%	RMC1/16S 333JTH	J24189043		1-	B	d4
R 1261	CHIP RES.	47k	1/16W	5%	RMC1/16S 473JTH	J24189045		1-	B	d4
R 1262	CHIP RES.	470k	1/16W	5%	RMC1/16S 474JTH	J24189057		1-	B	e4
R 1263	CHIP RES.	10k	1/16W	5%	RMC1/16S 103JTH	J24189037		1-	A	B4
R 1264	CHIP RES.	33k	1/16W	5%	RMC1/16S 333JTH	J24189043		1-	B	e4
R 1265	CHIP RES.	15k	1/16W	5%	RMC1/16S 153JTH	J24189039		1-	B	d4
R 1266	CHIP RES.	150k	1/16W	5%	RMC1/16S 154JTH	J24189051		1-	B	d4
R 1267	CHIP RES.	10k	1/16W	5%	RMC1/16S 103JTH	J24189037		1-	B	e4
R 1268	CHIP RES.	33k	1/16W	5%	RMC1/16S 333JTH	J24189043		1-	B	d4
R 1269	CHIP RES.	330k	1/16W	5%	RMC1/16S 334JTH	J24189055		1-	B	e4
R 1270	CHIP RES.	33k	1/16W	5%	RMC1/16S 333JTH	J24189043		1-	B	d4
R 1271	CHIP RES.	100k	1/16W	5%	RMC1/16S 104JTH	J24189049		1-	B	e4
R 1272	CHIP RES.	47k	1/16W	5%	RMC1/16S 473JTH	J24189045		1-	B	e4
R 1273	CHIP RES.	47k	1/16W	5%	RMC1/16S 473JTH	J24189045		1-	B	e4
R 1274	CHIP RES.	100k	1/16W	5%	RMC1/16S 104JTH	J24189049		1-	B	e4
R 1275	CHIP RES.	10k	1/16W	5%	RMC1/16S 103JTH	J24189037		1-	B	e4
R 1276	CHIP RES.	47k	1/16W	5%	RMC1/16S 473JTH	J24189045		1-	B	d4
R 1277	CHIP RES.	100k	1/16W	5%	RMC1/16S 104JTH	J24189049		1-	A	C5
R 1278	CHIP RES.	68k	1/16W	5%	RMC1/16S 683JTH	J24189047		1-	B	e4
R 1279	CHIP RES.	390k	1/16W	5%	RMC1/16S 394JTH	J24189056		1-	B	e4
R 1280	CHIP RES.	390k	1/16W	5%	RMC1/16S 394JTH	J24189056		1-	B	e4
R 1281	CHIP RES.	68k	1/16W	5%	RMC1/16S 683JTH	J24189047		1-	B	e4
R 1282	CHIP RES.	390k	1/16W	5%	RMC1/16S 394JTH	J24189056		1-	B	e4
R 1283	CHIP RES.	390k	1/16W	5%	RMC1/16S 394JTH	J24189056		1-	B	e4
R 1284	CHIP RES.	47k	1/16W	5%	RMC1/16S 473JTH	J24189045		1-	B	e4
R 1285	CHIP RES.	12k	1/16W	5%	RMC1/16S 123JTH	J24189038		1-	B	e4
R 1286	CHIP RES.	100k	1/16W	5%	RMC1/16S 104JTH	J24189049		1-	B	e4
R 1287	CHIP RES.	10k	1/16W	5%	RMC1/16S 103JTH	J24189037		1-	B	e4
R 1288	CHIP RES.	10k	1/16W	5%	RMC1/16S 103JTH	J24189037		1-	A	B4
R 1289	CHIP RES.	56k	1/16W	5%	RMC1/16S 563JTH	J24189046		1-	A	A4
R 1290	CHIP RES.	2.2k	1/16W	5%	RMC1/16S 222JTH	J24189029		1-	A	B4
R 1291	CHIP RES.	2.2k	1/16W	5%	RMC1/16S 222JTH	J24189029		1-	A	A4
R 1292	CHIP RES.	100	1/16W	5%	RMC1/16S 101JTH	J24189013		1-	B	f4
R 1294	CHIP RES.	100	1/16W	5%	RMC1/16S 101JTH	J24189013		1-	A	B4
R 1299	CHIP RES.	10k	1/16W	5%	RMC1/16S 103JTH	J24189037		1-	A	A3
R 1300	CHIP RES.	4.7k	1/16W	5%	RMC1/16S 472JTH	J24189033		1-	B	e3
R 1301	CHIP RES.	1k	1/16W	5%	RMC1/16S 102JTH	J24189025		1-	B	e3
R 1302	CHIP RES.	1k	1/16W	5%	RMC1/16S 102JTH	J24189025		1-	A	B3
R 1304	CHIP RES.	15	1/16W	5%	RMC1/16S 150JTH	J24189003		1-	B	g2
R 1305	CHIP RES.	15	1/16W	5%	RMC1/16S 150JTH	J24189003		1-	B	g2

MAIN Unit

Parts List

REF	DESCRIPTION	VALUE	V/W	TOL.	MFR'S DESIG	YAESU P/N	VERS.	LOT	SIDE	LAY ADR
R 1306	CHIP RES.	15	1/16W	5%	RMC1/16S 150JTH	J24189003		1-	B	f2
R 1307	CHIP RES.	15	1/16W	5%	RMC1/16S 150JTH	J24189003		1-	B	g2
R 1308	CHIP RES.	15	1/16W	5%	RMC1/16S 150JTH	J24189003		1-	B	f2
R 1309	CHIP RES.	15	1/16W	5%	RMC1/16S 150JTH	J24189003		1-	B	f2
R 1310	CHIP RES.	15	1/16W	5%	RMC1/16S 150JTH	J24189003		1-	B	f2
R 1311	CHIP RES.	15	1/16W	5%	RMC1/16S 150JTH	J24189003		1-	B	g2
R 1312	CHIP RES.	15	1/16W	5%	RMC1/16S 150JTH	J24189003		1-	B	f2
R 1313	CHIP RES.	15	1/16W	5%	RMC1/16S 150JTH	J24189003		1-	B	g2
R 1314	CHIP RES.	15	1/16W	5%	RMC1/16S 150JTH	J24189003		1-	B	g2
R 1315	CHIP RES.	15	1/16W	5%	RMC1/16S 150JTH	J24189003		1-	B	f2
R 1316	CHIP RES.	22	1/16W	5%	RMC1/16S 220JTH	J24189005		1-	B	g2
R 1317	CHIP RES.	15	1/16W	5%	RMC1/16S 150JTH	J24189003		1-	B	f1
R 1318	CHIP RES.	22	1/16W	5%	RMC1/16S 220JTH	J24189005		1-	B	g2
R 1319	CHIP RES.	15	1/16W	5%	RMC1/16S 150JTH	J24189003		1-	B	f1
R 1320	CHIP RES.	22	1/16W	5%	RMC1/16S 220JTH	J24189005		1-	B	g2
R 1321	CHIP RES.	15	1/16W	5%	RMC1/16S 150JTH	J24189003		1-	B	f1
R 1322	CHIP RES.	22	1/16W	5%	RMC1/16S 220JTH	J24189005		1-	B	g2
R 1323	CHIP RES.	15	1/16W	5%	RMC1/16S 150JTH	J24189003		1-	B	f2
R 1324	CHIP RES.	22	1/16W	5%	RMC1/16S 220JTH	J24189005		1-	B	g2
R 1325	CHIP RES.	15	1/16W	5%	RMC1/16S 150JTH	J24189003		1-	B	f1
R 1326	CHIP RES.	22	1/16W	5%	RMC1/16S 220JTH	J24189005		1-	B	g2
R 1327	CHIP RES.	15	1/16W	5%	RMC1/16S 150JTH	J24189003		1-	B	f1
R 1328	CHIP RES.	22	1/16W	5%	RMC1/16S 220JTH	J24189005		1-	B	g2
R 1329	CHIP RES.	15	1/16W	5%	RMC1/16S 150JTH	J24189003		1-	B	f2
R 1330	CHIP RES.	22	1/16W	5%	RMC1/16S 220JTH	J24189005		1-	B	g2
R 1331	CHIP RES.	15	1/16W	5%	RMC1/16S 150JTH	J24189003		1-	B	f2
R 1332	CHIP RES.	22	1/16W	5%	RMC1/16S 220JTH	J24189005		1-	B	g2
R 1333	CHIP RES.	15	1/16W	5%	RMC1/16S 150JTH	J24189003		1-	B	f2
R 1334	CHIP RES.	22	1/16W	5%	RMC1/16S 220JTH	J24189005		1-	B	g2
R 1335	CHIP RES.	15	1/16W	5%	RMC1/16S 150JTH	J24189003		1-	B	f2
R 1336	CHIP RES.	22	1/16W	5%	RMC1/16S 220JTH	J24189005		1-	B	g2
R 1337	CHIP RES.	10k	1/16W	5%	RMC1/16S 103JTH	J24189037		1-	A	A4
R 1338	CHIP RES.	1k	1/16W	5%	RMC1/16S 102JTH	J24189025		1-	A	A3
R 1340	CHIP RES.	22k	1/16W	5%	RMC1/16S 223JTH	J24189041		1-	A	A4
R 1342	CHIP RES.	470k	1/16W	5%	RMC1/16S 474JTH	J24189057		1-	A	A4
R 1344	CHIP RES.	1M	1/16W	5%	RMC1/16S 105JTH	J24189061		1-	B	f3
R 1345	CHIP RES.	330k	1/16W	5%	RMC1/16S 334JTH	J24189055		1-	A	A3
R 1347	CHIP RES.	1k	1/16W	5%	RMC1/16S 102JTH	J24189025		1-	A	A3
R 1348	CHIP RES.	100k	1/16W	5%	RMC1/16S 104JTH	J24189049		1-	B	f3
R 1349	CHIP RES.	330k	1/16W	5%	RMC1/16S 334JTH	J24189055		1-	B	f3
R 1350	CHIP RES.	100	1/16W	5%	RMC1/16S 101JTH	J24189013		1-	A	E5
R 1354	CHIP RES.	220k	1/16W	5%	RMC1/16S 224JTH	J24189053		1-	B	c5
R 1355	CHIP RES.	150k	1/16W	5%	RMC1/16S 154JTH	J24189051		1-	B	c5
R 1356	CHIP RES.	390k	1/16W	5%	RMC1/16S 394JTH	J24189056		1-	A	E5
R 1357	CHIP RES.	4.7k	1/16W	5%	RMC1/16S 472JTH	J24189033		1-	A	E5
R 1405	CHIP RES.	270k	1/16W	5%	RMC1/16S 274JTH	J24189054		1-	B	e5
R 1406	CHIP RES.	100	1/16W	5%	RMC1/16S 101JTH	J24189013		1-	A	B4
R 1408	CHIP RES.	22k	1/16W	5%	RMC1/16S 223JTH	J24189041		1-	A	C4
R 1409	CHIP RES.	12k	1/16W	5%	RMC1/16S 123JTH	J24189038		1-	B	e5
R 1410	CHIP RES.	22k	1/16W	5%	RMC1/16S 223JTH	J24189041		1-	B	e5
R 1411	CHIP RES.	150k	1/16W	5%	RMC1/16S 154JTH	J24189051		1-	B	e4
R 1412	CHIP RES.	220k	1/16W	5%	RMC1/16S 224JTH	J24189053		1-	B	e4
R 1413	CHIP RES.	10k	1/16W	5%	RMC1/16S 103JTH	J24189037		1-	B	e4
R 1414	CHIP RES.	220k	1/16W	5%	RMC1/16S 224JTH	J24189053		1-	B	e4
R 1415	CHIP RES.	270k	1/16W	5%	RMC1/16S 274JTH	J24189054		1-	B	e4
R 1416	CHIP RES.	220k	1/16W	5%	RMC1/16S 224JTH	J24189053		1-	B	e4
R 1417	CHIP RES.	220k	1/16W	5%	RMC1/16S 224JTH	J24189053		1-	B	e4
R 1418	CHIP RES.	3.9k	1/16W	0.5%	RR0510P-392-D	J24189133		1-	B	e5
R 1419	CHIP RES.	22k	1/16W	5%	RMC1/16S 223JTH	J24189041		1-	B	e5
R 1420	CHIP RES.	4.7k	1/16W	0.5%	RR0510P-472-D	J24189135		1-	B	e5
R 1421	CHIP RES.	1M	1/16W	5%	RMC1/16S 105JTH	J24189061		1-	B	e5
R 1422	CHIP RES.	56k	1/16W	0.5%	RR0510R-563-D	J24189161		1-	B	e5
R 1423	CHIP RES.	100k	1/16W	0.5%	RR0510R-104-D	J24189167		1-	B	e5
R 1424	CHIP RES.	18k	1/16W	0.5%	RR0510R-183-D	J24189149		1-	B	e5
R 1425	CHIP RES.	82k	1/16W	0.5%	RR0510R-823-D	J24189165		1-	B	e5
R 1426	CHIP RES.	330k	1/16W	5%	RMC1/16S 334JTH	J24189055		1-	B	e5
R 1427	CHIP RES.	100	1/16W	5%	RMC1/16S 101JTH	J24189013		1-	A	C4
R 1428	CHIP RES.	470k	1/16W	5%	RMC1/16S 474JTH	J24189057		1-	B	e5
R 1438	CHIP RES.	4.7k	1/16W	5%	RMC1/16S 472JTH	J24189033		1-	B	c3
R 1439	CHIP RES.	4.7k	1/16W	5%	RMC1/16S 472JTH	J24189033		1-	B	c3
R 1440	CHIP RES.	33k	1/16W	5%	RMC1/16S 333JTH	J24189043		1-	B	c3
R 1441	CHIP RES.	220k	1/16W	5%	RMC1/16S 224JTH	J24189053		1-	B	d3
R 1497	CHIP RES.	100	1/16W	5%	RMC1/16S 101JTH	J24189013		1-	B	e3

MAIN Unit

Parts List

REF	DESCRIPTION	VALUE	V/W	TOL.	MFR'S DESIG	YAESU P/N	VERS.	LOT	SIDE	LAY ADR
R 1498	CHIP RES.	2.2k	1/16W	5%	RMC1/16S 222JTH	J24189029		1-	B	e2
R 1499	CHIP RES.	2.2k	1/16W	5%	RMC1/16S 222JTH	J24189029		1-	B	e2
R 1501	CHIP RES.	33	1/16W	5%	RMC1/16S 330JTH	J24189007		1-	A	F3
R 1502	CHIP RES.	10k	1/16W	5%	RMC1/16S 103JTH	J24189037		1-	A	E2
R 1503	CHIP RES.	10k	1/16W	5%	RMC1/16S 103JTH	J24189037		1-	A	E2
R 1504	CHIP RES.	10k	1/16W	5%	RMC1/16S 103JTH	J24189037		1-	B	b2
R 1505	CHIP RES.	10k	1/16W	5%	RMC1/16S 103JTH	J24189037		1-	B	b2
R 1506	CHIP RES.	33	1/16W	5%	RMC1/16S 330JTH	J24189007		1-	B	b2
R 1507	CHIP RES.	33	1/16W	5%	RMC1/16S 330JTH	J24189007		1-	A	F3
R 1508	CHIP RES.	10k	1/16W	5%	RMC1/16S 103JTH	J24189037		1-	A	F3
R 1509	CHIP RES.	10k	1/16W	5%	RMC1/16S 103JTH	J24189037		1-	A	F3
R 1510	CHIP RES.	1M	1/16W	5%	RMC1/16S 105JTH	J24189061		1-	B	c3
R 1511	CHIP RES.	10k	1/16W	5%	RMC1/16S 103JTH	J24189037		1-	B	b3
R 1512	CHIP RES.	10k	1/16W	5%	RMC1/16S 103JTH	J24189037		1-	B	b3
R 1513	CHIP RES.	3.3k	1/16W	5%	RMC1/16S 332JTH	J24189031		1-	B	e2
R 1514	CHIP RES.	3.3k	1/16W	5%	RMC1/16S 332JTH	J24189031		1-	B	e2
R 1515	CHIP RES.	3.3k	1/16W	5%	RMC1/16S 332JTH	J24189031		1-	A	B2
R 1516	CHIP RES.	3.3k	1/16W	5%	RMC1/16S 332JTH	J24189031		1-	A	B2
R 1517	CHIP RES.	3.3k	1/16W	5%	RMC1/16S 332JTH	J24189031		1-	B	e2
R 1518	CHIP RES.	3.3k	1/16W	5%	RMC1/16S 332JTH	J24189031		1-	B	e2
R 1519	CHIP RES.	3.3k	1/16W	5%	RMC1/16S 332JTH	J24189031		1-	B	e2
R 1520	CHIP RES.	3.3k	1/16W	5%	RMC1/16S 332JTH	J24189031		1-	B	e2
R 1521	CHIP RES.	3.3k	1/16W	5%	RMC1/16S 332JTH	J24189031		1-	B	e2
R 1522	CHIP RES.	47	1/16W	5%	RMC1/16S 470JTH	J24189009		1-	B	e3
R 1523	CHIP RES.	3.3k	1/16W	5%	RMC1/16S 332JTH	J24189031		1-	B	e2
R 1524	CHIP RES.	3.3k	1/16W	5%	RMC1/16S 332JTH	J24189031		1-	B	e2
R 1525	CHIP RES.	3.3k	1/16W	5%	RMC1/16S 332JTH	J24189031		1-	B	e2
R 1526	CHIP RES.	1k	1/16W	5%	RMC1/16 102JATP	J24185102		1-	A	C2
R 1527	CHIP RES.	1k	1/16W	5%	RMC1/16 102JATP	J24185102		1-	A	B2
R 1528	CHIP RES.	1k	1/16W	5%	RMC1/16 102JATP	J24185102		1-	A	C2
R 1529	CHIP RES.	1k	1/16W	5%	RMC1/16 102JATP	J24185102		1-	A	C2
R 1530	CHIP RES.	1k	1/16W	5%	RMC1/16 102JATP	J24185102		1-	B	d2
R 1531	CHIP RES.	3.3k	1/16W	5%	RMC1/16S 332JTH	J24189031		1-	B	e2
R 1532	CHIP RES.	18k	1/16W	5%	RMC1/16S 183JTH	J24189040		1-	B	d2
R 1533	CHIP RES.	1k	1/16W	5%	RMC1/16 102JATP	J24185102		1-	B	d2
R 1534	CHIP RES.	1k	1/16W	5%	RMC1/16 102JATP	J24185102		1-	B	d2
R 1535	CHIP RES.	1k	1/16W	5%	RMC1/16 102JATP	J24185102		1-	B	d2
R 1536	CHIP RES.	33k	1/16W	5%	RMC1/16S 333JTH	J24189043		1-	B	d2
R 1537	CHIP RES.	10	1/16W	5%	RMC1/16S 100JTH	J24189001		1-	A	C2
R 1538	CHIP RES.	10	1/16W	5%	RMC1/16S 100JTH	J24189001		1-	A	C2
R 1539	CHIP RES.	10	1/16W	5%	RMC1/16S 100JTH	J24189001		1-	A	C2
R 1540	CHIP RES.	10	1/16W	5%	RMC1/16S 100JTH	J24189001		1-	A	C2
R 1541	CHIP RES.	0	1/16W	5%	RMC1/16S JPTH	J24189070		1-	B	c4
R 1542	CHIP RES.	1.5k	1/16W	5%	RMC1/16S 152JTH	J24189027		1-	A	C3
R 1543	CHIP RES.	1.5k	1/16W	5%	RMC1/16S 152JTH	J24189027		1-	A	C3
R 1544	CHIP RES.	1.5k	1/16W	5%	RMC1/16S 152JTH	J24189027		1-	A	C3
R 1545	CHIP RES.	1.5k	1/16W	5%	RMC1/16S 152JTH	J24189027		1-	A	C3
R 1546	CHIP RES.	1.5k	1/16W	5%	RMC1/16S 152JTH	J24189027		1-	A	C3
R 1547	CHIP RES.	1.5k	1/16W	5%	RMC1/16S 152JTH	J24189027		1-	A	C3
R 1549	CHIP RES.	22k	1/16W	5%	RMC1/16S 223JTH	J24189041		1-	B	d3
R 1550	CHIP RES.	82	1/16W	5%	RMC1/16S 820JTH	J24189012		1-	B	d3
R 1551	CHIP RES.	82	1/16W	5%	RMC1/16S 820JTH	J24189012		1-	B	d3
R 1552	CHIP RES.	6.8k	1/16W	5%	RMC1/16S 682JTH	J24189035		1-	B	d3
R 1553	CHIP RES.	33	1/16W	5%	RMC1/16S 330JTH	J24189007		1-	A	C3
R 1554	CHIP RES.	33	1/16W	5%	RMC1/16S 330JTH	J24189007		1-	A	C3
R 1555	CHIP RES.	100	1/16W	5%	RMC1/16S 101JTH	J24189013		1-	A	C3
R 1556	CHIP RES.	100	1/16W	5%	RMC1/16S 101JTH	J24189013		1-	A	C3
R 1557	CHIP RES.	100	1/16W	5%	RMC1/16S 101JTH	J24189013		1-	A	D3
R 1558	CHIP RES.	0	1/16W	5%	RMC1/16 000JATP	J24185000		1-	A	D3
R 1559	CHIP RES.	6.8k	1/16W	5%	RMC1/16S 682JTH	J24189035		1-	B	d3
R 1560	CHIP RES.	100k	1/16W	5%	RMC1/16S 104JTH	J24189049		1-	B	d3
R 1561	CHIP RES.	220	1/16W	5%	RMC1/16S 221JTH	J24189017		1-	B	d3
R 1562	CHIP RES.	33	1/16W	5%	RMC1/16S 330JTH	J24189007		1-	B	e1
R 1563	CHIP RES.	33	1/16W	5%	RMC1/16S 330JTH	J24189007		1-	B	e1
R 1564	CHIP RES.	33	1/16W	5%	RMC1/16S 330JTH	J24189007		1-	B	e1
R 1565	CHIP RES.	33	1/16W	5%	RMC1/16S 330JTH	J24189007		1-	B	e1
R 1566	CHIP RES.	47	1/16W	5%	RMC1/16S 470JTH	J24189009		1-	B	d4
R 1567	CHIP RES.	100	1/16W	5%	RMC1/16S 101JTH	J24189013		1-	B	c4
R 1568	CHIP RES.	1k	1/16W	5%	RMC1/16S 102JTH	J24189025		1-	B	d4
R 1569	CHIP RES.	22	1/16W	5%	RMC1/16S 220JTH	J24189005		1-	B	c4
R 1570	CHIP RES.	22k	1/16W	5%	RMC1/16S 223JTH	J24189041		1-	B	d3
R 1571	CHIP RES.	4.7k	1/16W	5%	RMC1/16S 472JTH	J24189033		1-	B	d4
R 1572	CHIP RES.	4.7k	1/16W	5%	RMC1/16S 472JTH	J24189033		1-	A	A1

MAIN Unit

Parts List

REF	DESCRIPTION	VALUE	V/W	TOL.	MFR'S DESIG	YAESU P/N	VERS.	LOT	SIDE	LAY ADR
R 1574	CHIP RES.	150	1/16W	5%	RMC1/16S 151JTH	J24189015		1-	B	d4
R 1575	CHIP RES.	47	1/16W	5%	RMC1/16S 470JTH	J24189009		1-	B	c4
R 1576	CHIP RES.	1k	1/16W	5%	RMC1/16S 102JTH	J24189025		1-	B	c3
R 1577	CHIP RES.	100	1/16W	5%	RMC1/16S 101JTH	J24189013		1-	B	d3
R 1578	CHIP RES.	330k	1/16W	5%	RMC1/16S 334JTH	J24189055		1-	B	c3
R 1579	CHIP RES.	330k	1/16W	5%	RMC1/16S 334JTH	J24189055		1-	B	c3
R 1580	CHIP RES.	2.2M	1/16W	5%	RMC1/16S 225JTH	J24189065		1-	B	c3
R 1581	CHIP RES.	100	1/16W	5%	RMC1/16S 101JTH	J24189013		1-	B	c3
R 1582	CHIP RES.	100	1/16W	5%	RMC1/16S 101JTH	J24189013		1-	B	c3
R 1583	CHIP RES.	100	1/16W	5%	RMC1/16S 101JTH	J24189013		1-	B	c3
R 1584	CHIP RES.	1k	1/16W	5%	RMC1/16S 102JTH	J24189025		1-	B	e3
R 1585	CHIP RES.	47k	1/16W	5%	RMC1/16S 473JTH	J24189045		1-	B	e3
R 1588	CHIP RES.	2.2k	1/16W	0.5%	RR0510P-222-D	J24189127		1-	B	c3
R 1637	CHIP RES.	100k	1/16W	5%	RMC1/16S 104JTH	J24189049		1-	A	D5
R 1641	CHIP RES.	22k	1/16W	5%	RMC1/16S 223JTH	J24189041		1-	A	D4
R 1642	CHIP RES.	4.7k	1/16W	5%	RMC1/16S 472JTH	J24189033		1-	A	D4
R 1643	CHIP RES.	47	1/16W	5%	RMC1/16S 470JTH	J24189009		1-	A	D4
R 1644	CHIP RES.	100	1/16W	5%	RMC1/16S 101JTH	J24189013		1-	B	c4
R 1645	CHIP RES.	33k	1/16W	5%	RMC1/16S 333JTH	J24189043		1-	B	c4
R 1646	CHIP RES.	47	1/16W	5%	RMC1/16S 470JTH	J24189009		1-	B	c4
R 1647	CHIP RES.	100k	1/16W	5%	RMC1/16S 104JTH	J24189049		1-	A	D4
R 1648	CHIP RES.	10k	1/16W	0.5%	RR0510P-103-D	J24189143		1-	B	c4
R 1649	CHIP RES.	22k	1/16W	0.5%	RR0510R-223-D	J24189151		1-	B	c4
R 1650	CHIP RES.	680	1/16W	0.5%	RR0510P-681-D	J24189115		1-	B	c4
R 1651	CHIP RES.	1k	1/16W	5%	RMC1/16S 102JTH	J24189025		1-	B	c4
R 1652	CHIP RES.	180	1/16W	5%	RMC1/16S 181JTH	J24189016		1-	B	c5
R 1653	CHIP RES.	470	1/16W	5%	RMC1/16S 471JTH	J24189021		1-	B	c5
R 1654	CHIP RES.	100	1/16W	5%	RMC1/16S 101JTH	J24189013		1-	A	D5
R 1655	CHIP RES.	100k	1/16W	5%	RMC1/16S 104JTH	J24189049		1-	B	c5
R 1656	CHIP RES.	100k	1/16W	5%	RMC1/16S 104JTH	J24189049		1-	A	D4
R 1657	CHIP RES.	47	1/16W	5%	RMC1/16S 470JTH	J24189009		1-	A	D4
R 1658	CHIP RES.	100	1/16W	5%	RMC1/16S 101JTH	J24189013		1-	A	D4
R 1659	CHIP RES.	220	1/16W	5%	RMC1/16S 221JTH	J24189017		1-	A	D4
R 1660	CHIP RES.	1k	1/16W	5%	RMC1/16S 102JTH	J24189025		1-	B	c4
R 1661	CHIP RES.	33k	1/16W	5%	RMC1/16S 333JTH	J24189043		1-	B	d4
R 1662	CHIP RES.	220	1/16W	5%	RMC1/16S 221JTH	J24189017		1-	B	d4
R 1663	CHIP RES.	15k	1/16W	0.5%	RR0510R-153-D	J24189147		1-	B	d4
R 1664	CHIP RES.	22k	1/16W	0.5%	RR0510R-223-D	J24189151		1-	B	c4
R 1665	CHIP RES.	1k	1/16W	5%	RMC1/16S 102JTH	J24189025		1-	B	d4
R 1666	CHIP RES.	680	1/16W	0.5%	RR0510P-681-D	J24189115		1-	B	d4
R 1667	CHIP RES.	270	1/16W	5%	RMC1/16S 271JTH	J24189018		1-	B	d5
R 1668	CHIP RES.	120k	1/16W	5%	RMC1/16S 124JTH	J24189050		1-	B	d5
R 1669	CHIP RES.	470	1/16W	5%	RMC1/16S 471JTH	J24189021		1-	B	d5
R 1671	CHIP RES.	1k	1/16W	5%	RMC1/16S 102JTH	J24189025		1-	B	d4
R 1672	CHIP RES.	330	1/16W	5%	RMC1/16S 331JTH	J24189019		1-	A	D4
R 1673	CHIP RES.	2.2k	1/16W	5%	RMC1/16S 222JTH	J24189029		1-	A	D4
R 1674	CHIP RES.	680	1/16W	5%	RMC1/16S 681JTH	J24189023		1-	A	D4
R 1675	CHIP RES.	2.2k	1/16W	5%	RMC1/16S 222JTH	J24189029		1-	A	D4
R 1676	CHIP RES.	10k	1/16W	5%	RMC1/16S 103JTH	J24189037		1-	A	D4
R 1677	CHIP RES.	150	1/16W	5%	RMC1/16S 151JTH	J24189015		1-	A	D4
R 1678	CHIP RES.	680k	1/16W	5%	RMC1/16S 684JTH	J24189059		1-	A	D4
R 1679	CHIP RES.	100	1/16W	5%	RMC1/16S 101JTH	J24189013		1-	A	D5
R 1680	CHIP RES.	10k	1/16W	5%	RMC1/16S 103JTH	J24189037		1-	A	D5
R 1681	CHIP RES.	10k	1/16W	5%	RMC1/16S 103JTH	J24189037		1-	A	D5
R 1682	CHIP RES.	10k	1/16W	5%	RMC1/16S 103JTH	J24189037		1-	A	D5
R 1683	CHIP RES.	1k	1/16W	5%	RMC1/16S 102JTH	J24189025		1-	A	D5
R 1684	CHIP RES.	1k	1/16W	5%	RMC1/16S 102JTH	J24189025		1-	A	D5
R 1685	CHIP RES.	1k	1/16W	5%	RMC1/16S 102JTH	J24189025		1-	A	D5
R 1686	CHIP RES.	10k	1/16W	5%	RMC1/16S 103JTH	J24189037		1-	B	c5
R 1687	CHIP RES.	2.2k	1/16W	5%	RMC1/16S 222JTH	J24189029		1-	A	D5
R 1688	CHIP RES.	1k	1/16W	5%	RMC1/16S 102JTH	J24189025		1-	B	b3
R 1695	CHIP RES.	100k	1/16W	5%	RMC1/16S 104JTH	J24189049		1-	B	c5
R 1702	CHIP RES.	0	1/16W	5%	RMC1/16S JPTH	J24189070		1-	B	c5
R 1703	CHIP RES.	220k	1/16W	5%	RMC1/16S 224JTH	J24189053		1-	A	D5
R 1704	CHIP RES.	100k	1/16W	5%	RMC1/16S 104JTH	J24189049		1-	B	c5
R 1705	CHIP RES.	22k	1/16W	5%	RMC1/16S 223JTH	J24189041		1-	A	D5
R 1706	CHIP RES.	18k	1/16W	5%	RMC1/16S 183JTH	J24189040		1-	A	D4
R 1707	CHIP RES.	100k	1/16W	5%	RMC1/16S 104JTH	J24189049		1-	A	D5
R 1708	CHIP RES.	47	1/16W	5%	RMC1/16S 470JTH	J24189009		1-	A	D5
R 1709	CHIP RES.	4.7k	1/16W	5%	RMC1/16S 472JTH	J24189033		1-	A	D4
R 1711	CHIP RES.	100k	1/16W	5%	RMC1/16S 104JTH	J24189049		1-	B	f5
R 1712	CHIP RES.	100k	1/16W	5%	RMC1/16S 104JTH	J24189049		1-	B	f5
R 1715	CHIP RES.	470k	1/16W	5%	RMC1/16S 474JTH	J24189057		1-	B	e4

MAIN Unit

Parts List

REF	DESCRIPTION	VALUE	V/W	TOL.	MFR'S DESIG	YAESU P/N	VERS.	LOT	SIDE	LAY ADR
R 1716	CHIP RES.	220k	1/16W	0.5%	MCR01MZPD2203	J24189389		1-	B	f5
R 1717	CHIP RES.	51k	1/16W	5%	RMC1/16S 513JTH	J24189391		1-	B	f5
R 1718	CHIP RES.	100k	1/16W	0.5%	RR0510R-104-D	J24189167		1-	B	f4
R 1719	CHIP RES.	100k	1/16W	0.5%	RR0510R-104-D	J24189167		1-	B	f4
R 1720	CHIP RES.	560k	1/16W	0.5%	MCR01MZPD5603	J24189335		1-	B	f5
R 1721	CHIP RES.	10k	1/16W	5%	RMC1/16S 103JTH	J24189037		1-	B	f5
R 1722	CHIP RES.	82k	1/16W	0.5%	RR0510R-823-D	J24189165		1-	B	f4
R 1724	CHIP RES.	10k	1/16W	5%	RMC1/16S 103JTH	J24189037		1-	B	f4
R 1725	CHIP RES.	100k	1/16W	0.5%	RR0510R-104-D	J24189167		1-	B	f4
R 1726	CHIP RES.	22k	1/16W	5%	RMC1/16S 223JTH	J24189041		1-	B	e5
R 1727	CHIP RES.	100k	1/16W	5%	RMC1/16S 104JTH	J24189049		1-	B	e5
R 1728	CHIP RES.	100k	1/16W	5%	RMC1/16S 104JTH	J24189049		1-	B	e5
R 1729	CHIP RES.	47k	1/16W	5%	RMC1/16S 473JTH	J24189045		1-	B	f5
R 1730	CHIP RES.	10k	1/16W	5%	RMC1/16S 103JTH	J24189037		1-	B	f5
R 1731	CHIP RES.	220k	1/16W	5%	RMC1/16S 224JTH	J24189053		1-	B	f5
R 1732	CHIP RES.	100k	1/16W	5%	RMC1/16S 104JTH	J24189049		1-	B	f5
R 1733	CHIP RES.	100k	1/16W	5%	RMC1/16S 104JTH	J24189049		1-	B	f5
R 1734	CHIP RES.	1k	1/16W	5%	RMC1/16S 102JTH	J24189025		1-	B	e5
R 1735	CHIP RES.	10k	1/16W	5%	RMC1/16S 103JTH	J24189037		1-	B	f4
R 1736	CHIP RES.	68k	1/16W	5%	RMC1/16S 683JTH	J24189047		1-	B	f5
R 1737	CHIP RES.	100k	1/16W	0.5%	RR0510R-104-D	J24189167		1-	B	f4
R 1738	CHIP RES.	27k	1/16W	5%	RMC1/16S 273JTH	J24189042		1-	B	f4
R 1739	CHIP RES.	470k	1/16W	5%	RMC1/16S 474JTH	J24189057		1-	B	f4
R 1740	CHIP RES.	1k	1/16W	5%	RMC1/16S 102JTH	J24189025		1-	A	B3
R 1742	CHIP RES.	100k	1/16W	5%	RMC1/16S 104JTH	J24189049		1-	A	C4
R 1748	CHIP RES.	22k	1/16W	5%	RMC1/16S 223JTH	J24189041		1-	B	e5
R 1750	CHIP RES.	470k	1/16W	5%	RMC1/16S 474JTH	J24189057		1-	A	B4
R 1751	CHIP RES.	2.2k	1/16W	5%	RMC1/16S 222JTH	J24189029		1-	A	E6
R 1752	CHIP RES.	2.2k	1/16W	5%	RMC1/16S 222JTH	J24189029		1-	A	E6
R 1753	CHIP RES.	47k	1/16W	5%	RMC1/16S 473JTH	J24189045		1-	A	E6
R 1754	CHIP RES.	470k	1/16W	5%	RMC1/16S 474JTH	J24189057		1-	A	E6
R 1758	CHIP RES.	8.2k	1/16W	5%	RMC1/16S 822JTH	J24189036		1-	A	D5
R 1759	CHIP RES.	15k	1/16W	5%	RMC1/16S 153JTH	J24189039		1-	A	D5
R 1762	CHIP RES.	1k	1/16W	5%	RMC1/16S 102JTH	J24189025		1-	B	f6
R 1763	CHIP RES.	22k	1/16W	5%	RMC1/16S 223JTH	J24189041		1-	B	f5
R 1764	CHIP RES.	47k	1/16W	5%	RMC1/16S 473JTH	J24189045		1-	B	g5
R 1765	CHIP RES.	100k	1/16W	0.5%	RR0510R-104-D	J24189167		1-	B	f4
R 1766	CHIP RES.	330k	1/16W	5%	RMC1/16S 334JTH	J24189055		1-	B	f4
R 1767	CHIP RES.	470k	1/16W	5%	RMC1/16S 474JTH	J24189057		1-	B	g4
R 1768	CHIP RES.	470k	1/16W	5%	RMC1/16S 474JTH	J24189057		1-	B	g4
R 1769	CHIP RES.	150k	1/16W	0.5%	MCR01MZPD1503	J24189328		1-	B	f4
R 1770	CHIP RES.	150k	1/16W	0.5%	MCR01MZPD1503	J24189328		1-	B	f4
R 1771	CHIP RES.	470k	1/16W	5%	RMC1/16S 474JTH	J24189057		1-	B	g4
R 1772	CHIP RES.	150k	1/16W	0.5%	MCR01MZPD1503	J24189328		1-	B	f4
R 1773	CHIP RES.	10k	1/16W	5%	RMC1/16S 103JTH	J24189037		1-	B	f4
R 1774	CHIP RES.	15k	1/16W	5%	RMC1/16S 153JTH	J24189039		1-	B	f4
R 1775	CHIP RES.	22k	1/16W	5%	RMC1/16S 223JTH	J24189041		1-	B	f4
R 1776	CHIP RES.	390	1/16W	5%	RMC1/16S 391JTH	J24189020		1-	A	C6
R 1777	CHIP RES.	390	1/16W	5%	RMC1/16S 391JTH	J24189020		1-	A	D6
R 1778	CHIP RES.	390	1/16W	5%	RMC1/16S 391JTH	J24189020		1-	A	D6
R 1779	CHIP RES.	390	1/16W	5%	RMC1/16S 391JTH	J24189020		1-	A	C6
R 1780	CHIP RES.	390	1/16W	5%	RMC1/16S 391JTH	J24189020		1-	A	D6
R 1781	CHIP RES.	390	1/16W	5%	RMC1/16S 391JTH	J24189020		1-	A	C6
R 1782	CHIP RES.	330k	1/16W	5%	RMC1/16S 334JTH	J24189055		1-	A	E6
R 1783	CHIP RES.	100k	1/16W	5%	RMC1/16S 104JTH	J24189049		1-	B	f6
R 1784	CHIP RES.	100k	1/16W	5%	RMC1/16S 104JTH	J24189049		1-	B	e6
R 1786	CHIP RES.	10	1/16W	5%	RMC1/16S 100JTH	J24189001		1-	B	e5
R 1787	CHIP RES.	150k	1/16W	5%	RMC1/16S 154JTH	J24189051		1-	B	d6
R 1788	CHIP RES.	10	1/16W	5%	RMC1/16S 100JTH	J24189001		1-	B	e5
R 1789	CHIP RES.	15k	1/16W	5%	RMC1/16S 153JTH	J24189039		1-	B	d6
R 1790	CHIP RES.	2.2k	1/16W	5%	RMC1/16S 222JTH	J24189029		1-	A	D6
R 1791	CHIP RES.	3.3k	1/16W	5%	RMC1/16S 332JTH	J24189031		1-	B	d6
R 1792	CHIP RES.	100	1/16W	5%	RMC1/16S 101JTH	J24189013		1-	B	d5
R 1793	CHIP RES.	2.2M	1/16W	5%	RMC1/16S 225JTH	J24189065		1-	B	d6
R 1794	CHIP RES.	33k	1/16W	5%	RMC1/16S 333JTH	J24189043		1-	B	d6
R 1795	CHIP RES.	10k	1/16W	5%	RMC1/16S 103JTH	J24189037		1-	B	d5
R 1796	CHIP RES.	47k	1/16W	5%	RMC1/16S 473JTH	J24189045		1-	B	d6
R 1797	CHIP RES.	15k	1/16W	5%	RMC1/16S 153JTH	J24189039		1-	B	d6
R 1798	CHIP RES.	1k	1/16W	5%	RMC1/16S 102JTH	J24189025		1-	B	d6
R 1799	CHIP RES.	4.7k	1/16W	5%	RMC1/16S 472JTH	J24189033		1-	B	d6
R 1800	CHIP RES.	180k	1/16W	5%	RMC1/16S 184JTH	J24189052		1-	B	d6
R 1801	CHIP RES.	100	1/16W	5%	RMC1/16S 101JTH	J24189013		1-	B	e2
R 1802	CHIP RES.	100	1/16W	5%	RMC1/16S 101JTH	J24189013		1-	B	e2

MAIN Unit

Parts List

REF	DESCRIPTION	VALUE	V/W	TOL.	MFR'S DESIG	YAESU P/N	VERS.	LOT	SIDE	LAY ADR
R 1803	CHIP RES.	100	1/16W	5%	RMC1/16S 101JTH	J24189013		1-	B	e2
R 1804	CHIP RES.	100	1/16W	5%	RMC1/16S 101JTH	J24189013		1-	B	e2
R 1805	CHIP RES.	4.7k	1/16W	5%	RMC1/16S 472JTH	J24189033		1-	A	B3
R 1806	CHIP RES.	4.7k	1/16W	5%	RMC1/16S 472JTH	J24189033		1-	A	A1
R 1807	CHIP RES.	330k	1/16W	5%	RMC1/16S 334JTH	J24189055		1-	B	e3
R 1808	CHIP RES.	390	1/16W	5%	RMC1/16S 391JTH	J24189020		1-	B	e3
R 1809	CHIP RES.	390	1/16W	5%	RMC1/16S 391JTH	J24189020		1-	B	e3
R 1810	CHIP RES.	390	1/16W	5%	RMC1/16S 391JTH	J24189020		1-	B	e3
R 1811	CHIP RES.	390	1/16W	5%	RMC1/16S 391JTH	J24189020		1-	B	e3
R 1812	CHIP RES.	390	1/16W	5%	RMC1/16S 391JTH	J24189020		1-	B	e3
R 1813	CHIP RES.	220	1/16W	5%	RMC1/16S 221JTH	J24189017		1-	A	B3
R 1814	CHIP RES.	220	1/16W	5%	RMC1/16S 221JTH	J24189017		1-	A	B3
R 1815	CHIP RES.	220	1/16W	5%	RMC1/16S 221JTH	J24189017		1-	A	B2
R 1816	CHIP RES.	220	1/16W	5%	RMC1/16S 221JTH	J24189017		1-	A	B2
R 1817	CHIP RES.	100k	1/16W	5%	RMC1/16S 104JTH	J24189049		1-	A	B2
R 1818	CHIP RES.	390	1/16W	5%	RMC1/16S 391JTH	J24189020		1-	B	e2
R 1819	CHIP RES.	390	1/16W	5%	RMC1/16S 391JTH	J24189020		1-	B	e2
R 1820	CHIP RES.	390	1/16W	5%	RMC1/16S 391JTH	J24189020		1-	B	e2
R 1821	CHIP RES.	390	1/16W	5%	RMC1/16S 391JTH	J24189020		1-	B	e2
R 1822	CHIP RES.	1k	1/16W	5%	RMC1/16S 102JTH	J24189025		1-	A	A4
R 1823	CHIP RES.	1k	1/16W	5%	RMC1/16S 102JTH	J24189025		1-	B	f4
R 1824	CHIP RES.	1k	1/16W	5%	RMC1/16S 102JTH	J24189025		1-	B	f5
R 1825	CHIP RES.	1k	1/16W	5%	RMC1/16S 102JTH	J24189025		1-	B	f4
R 1829	CHIP RES.	1M	1/16W	5%	RMC1/16S 105JTH	J24189061		1-	B	f5
R 1830	CHIP RES.	1k	1/16W	5%	RMC1/16S 102JTH	J24189025		1-	A	A5
R 1831	CHIP RES.	1k	1/16W	5%	RMC1/16S 102JTH	J24189025		1-	A	A5
R 1832	CHIP RES.	47k	1/16W	5%	RMC1/16S 473JTH	J24189045		1-	B	f5
R 1833	CHIP RES.	47	1/16W	5%	RMC1/16S 470JTH	J24189009		1-	A	A5
R 1834	CHIP RES.	1k	1/16W	5%	RMC1/16S 102JTH	J24189025		1-	B	f5
R 1835	CHIP RES.	220	1/16W	5%	RMC1/16S 221JTH	J24189017		1-	A	B5
R 1836	CHIP RES.	47k	1/16W	5%	RMC1/16S 473JTH	J24189045		1-	A	B4
R 1837	CHIP RES.	1k	1/16W	5%	RMC1/16S 102JTH	J24189025		1-	B	f5
R 1838	CHIP RES.	1k	1/16W	5%	RMC1/16S 102JTH	J24189025		1-	B	e5
R 1839	CHIP RES.	1k	1/16W	5%	RMC1/16S 102JTH	J24189025		1-	B	f5
R 1840	CHIP RES.	1k	1/16W	5%	RMC1/16S 102JTH	J24189025		1-	A	B5
R 1841	CHIP RES.	1k	1/16W	5%	RMC1/16S 102JTH	J24189025		1-	A	A6
R 1842	CHIP RES.	1k	1/16W	5%	RMC1/16S 102JTH	J24189025		1-	A	A5
R 1843	CHIP RES.	47k	1/16W	5%	RMC1/16S 473JTH	J24189045		1-	B	g6
R 1844	CHIP RES.	22k	1/16W	5%	RMC1/16S 223JTH	J24189041		1-	B	g5
R 1845	CHIP RES.	47k	1/16W	0.5%	MCR01MZPD4702	J24189382		1-	B	f6
R 1846	CHIP RES.	47k	1/16W	0.5%	MCR01MZPD4702	J24189382		1-	B	f6
R 1847	CHIP RES.	1k	1/16W	5%	RMC1/16S 102JTH	J24189025		1-	A	A6
R 1848	CHIP RES.	0	1/16W	5%	RMC1/16S JPTH	J24189070	VER A2:USA	1-	A	A6
R 1848	CHIP RES.	0	1/16W	5%	RMC1/16S JPTH	J24189070	VER C2	1-	A	A6
R 1848	CHIP RES.	0	1/16W	5%	RMC1/16S JPTH	J24189070	VER H2	1-	A	A6
R 1849	CHIP RES.	0	1/16W	5%	RMC1/16S JPTH	J24189070	VER A2:USA	1-	A	A6
R 1849	CHIP RES.	0	1/16W	5%	RMC1/16S JPTH	J24189070	VER B2	1-	A	A6
R 1849	CHIP RES.	0	1/16W	5%	RMC1/16S JPTH	J24189070	VER B3	1-	A	A6
R 1849	CHIP RES.	0	1/16W	5%	RMC1/16S JPTH	J24189070	VER H2	1-	A	A6
R 1850	CHIP RES.	0	1/16W	5%	RMC1/16S JPTH	J24189070	VER B2	1-	A	A6
R 1850	CHIP RES.	0	1/16W	5%	RMC1/16S JPTH	J24189070	VER C2	1-	A	A6
R 1850	CHIP RES.	0	1/16W	5%	RMC1/16S JPTH	J24189070	VER H2	1-	A	A6
R 1851	CHIP RES.	0	1/16W	5%	RMC1/16S JPTH	J24189070	VER A2:USA	1-	A	A6
R 1852	CHIP RES.	56k	1/16W	0.5%	MCR01MZPD5602	J24189383		1-	A	A6
R 1853	CHIP RES.	100k	1/16W	0.5%	MCR01MZPD1003	J24189386		1-	A	A6
R 1854	CHIP RES.	56k	1/16W	0.5%	MCR01MZPD5602	J24189383		1-	B	f6
R 1855	CHIP RES.	100k	1/16W	0.5%	MCR01MZPD1003	J24189386		1-	B	f6
R 1856	CHIP RES.	1k	1/16W	5%	RMC1/16S 102JTH	J24189025		1-	A	A6
R 1858	CHIP RES.	1k	1/16W	5%	RMC1/16S 102JTH	J24189025		1-	A	A6
R 1859	CHIP RES.	1k	1/16W	5%	RMC1/16S 102JTH	J24189025		1-	A	A6
R 1860	CHIP RES.	220	1/16W	5%	RMC1/16S 221JTH	J24189017		1-	A	B6
R 1861	CHIP RES.	220k	1/16W	5%	RMC1/16S 224JTH	J24189053		1-	B	f6
R 1862	CHIP RES.	100k	1/16W	0.5%	RR0510R-104-D	J24189167		1-	B	f6
R 1863	CHIP RES.	100k	1/16W	0.5%	RR0510R-104-D	J24189167		1-	B	f6
R 1864	CHIP RES.	1k	1/16W	5%	RMC1/16S 102JTH	J24189025		1-	B	f5
R 1865	CHIP RES.	1k	1/16W	5%	RMC1/16S 102JTH	J24189025		1-	A	B6
R 1866	CHIP RES.	1k	1/16W	5%	RMC1/16S 102JTH	J24189025		1-	B	f5
R 1867	CHIP RES.	1k	1/16W	5%	RMC1/16S 102JTH	J24189025		1-	A	B5
R 1868	CHIP RES.	1k	1/16W	5%	RMC1/16S 102JTH	J24189025		1-	B	f5
R 1869	CHIP RES.	100k	1/16W	5%	RMC1/16S 104JTH	J24189049		1-	A	B5
R 1871	CHIP RES.	22k	1/16W	5%	RMC1/16S 223JTH	J24189041		1-	B	g5
R 1872	CHIP RES.	68k	1/16W	5%	RMC1/16S 683JTH	J24189047		1-	B	e4
R 1873	CHIP RES.	10k	1/16W	5%	RMC1/16S 103JTH	J24189037		1-	B	f5

MAIN Unit

Parts List

REF	DESCRIPTION	VALUE	V/W	TOL.	MFR'S DESIG	YAESU P/N	VERS.	LOT	SIDE	LAY ADR
R 1874	CHIP RES.	2.2M	1/16W	5%	RMC1/16S 225JTH	J24189065		1-	B	f5
R 1877	CHIP RES.	56k	1/16W	5%	RMC1/16S 563JTH	J24189046		1-	B	f4
R 1878	CHIP RES.	33k	1/16W	5%	RMC1/16S 333JTH	J24189043		1-	B	f4
R 1879	CHIP RES.	1k	1/16W	5%	RMC1/16S 102JTH	J24189025		1-	A	A6
R 1883	CHIP RES.	330k	1/16W	5%	RMC1/16S 334JTH	J24189055		1-	A	A5
R 1884	CHIP RES.	12k	1/16W	5%	RMC1/16S 123JTH	J24189038		1-	A	D5
R 1885	CHIP RES.	4.7k	1/16W	5%	RMC1/16S 472JTH	J24189033		1-	B	e5
R 1886	CHIP RES.	100k	1/16W	5%	RMC1/16S 104JTH	J24189049		1-	A	E6
R 1887	CHIP RES.	47k	1/16W	5%	RMC1/16S 473JTH	J24189045		1-	B	e4
R 1888	CHIP RES.	4.7k	1/16W	5%	RMC1/16S 472JTH	J24189033		1-	B	e5
R 1889	CHIP RES.	220	1/16W	5%	RMC1/16S 221JTH	J24189017		1-	A	B5
R 1890	CHIP RES.	220	1/16W	5%	RMC1/16S 221JTH	J24189017		1-	A	B5
R 1891	CHIP RES.	1k	1/16W	5%	RMC1/16S 102JTH	J24189025		1-	A	B5
R 1892	CHIP RES.	1k	1/16W	5%	RMC1/16S 102JTH	J24189025		1-	A	B5
R 1893	CHIP RES.	470k	1/16W	5%	RMC1/16S 474JTH	J24189057		1-	A	A2
R 1894	CHIP RES.	100k	1/16W	5%	RMC1/16S 104JTH	J24189049		1-	A	E5
R 1895	CHIP RES.	100k	1/16W	5%	RMC1/16S 104JTH	J24189049		1-	A	E5
R 1896	CHIP RES.	47k	1/16W	0.5%	RR0510R-473-D	J24189159		1-	A	D5
R 1897	CHIP RES.	47k	1/16W	0.5%	RR0510R-473-D	J24189159		1-	A	D5
R 1898	CHIP RES.	2.2k	1/16W	5%	RMC1/16S 222JTH	J24189029		1-	B	c5
R 1901	CHIP RES.	1k	1/16W	5%	RMC1/16S 102JTH	J24189025		1-	B	f6
R 1902	CHIP RES.	470k	1/16W	5%	RMC1/16S 474JTH	J24189057		1-	A	B4
R 1903	CHIP RES.	470k	1/16W	5%	RMC1/16S 474JTH	J24189057		1-	A	B4
R 1906	CHIP RES.	100	1/16W	5%	RMC1/16S 101JTH	J24189013		1-	A	B4
R 1907	CHIP RES.	1k	1/16W	5%	RMC1/16S 102JTH	J24189025		1-	A	A5
R 1909	CHIP RES.	0	1/16W	5%	RMC1/16S JPTH	J24189070		1-	B	d6
R 1914	CHIP RES.	10	1/16W	5%	RMC1/16S 100JTH	J24189001		1-	A	C2
R 1915	CHIP RES.	10	1/16W	5%	RMC1/16S 100JTH	J24189001		1-	A	C2
R 1916	CHIP RES.	10	1/16W	5%	RMC1/16S 100JTH	J24189001		1-	A	C2
R 1917	CHIP RES.	10	1/16W	5%	RMC1/16S 100JTH	J24189001		1-	A	C2
R 1965	CHIP RES.	33k	1/16W	5%	RMC1/16S 333JTH	J24189043		1-	B	d4
R 1967	CHIP RES.	0	1/16W	5%	RMC1/16 000JATP	J24185000		1-	B	a2
R 1968	CHIP RES.	1k	1/16W	5%	RMC1/16S 102JTH	J24189025		1-	B	d6
R 1969	CHIP RES.	4.7k	1/16W	5%	RMC1/16S 472JTH	J24189033		1-	A	A4
R 1970	CHIP RES.	470k	1/16W	5%	RMC1/16S 474JTH	J24189057		1-	A	A4
R 1971	CHIP RES.	330k	1/16W	5%	RMC1/16S 334JTH	J24189055		1-	B	e5
R 1972	CHIP RES.	100k	1/16W	5%	RMC1/16S 104JTH	J24189049		1-	B	e5
R 1973	CHIP RES.	47k	1/16W	5%	RMC1/16S 473JTH	J24189045		1-	B	c4
R 1974	CHIP RES.	47k	1/16W	5%	RMC1/16S 473JTH	J24189045		1-	B	c3
R 1979	CHIP RES.	470k	1/16W	5%	RMC1/16S 474JTH	J24189057		1-	B	f6
R 1980	CHIP RES.	22k	1/16W	5%	RMC1/16S 223JTH	J24189041		1-	A	B3
R 1981	CHIP RES.	180	1/16W	5%	RMC1/16S 181JTH	J24189016		1-	B	c3
R 1982	CHIP RES.	120	1/16W	5%	RMC1/16S 121JTH	J24189014		1-	A	D3
R 1983	CHIP RES.	0	1/16W	5%	RMC1/16S JPTH	J24189070		1-	A	B4
R 1984	CHIP RES.	1k	1/16W	5%	RMC1/16S 102JTH	J24189025		1-	A	B4
R 1985	CHIP RES.	1k	1/16W	5%	RMC1/16S 102JTH	J24189025		1-	A	B4
R 1986	CHIP RES.	2.4k	1/16W	0.5%	RR0510P-242-D	J24189589		1-	B	e3
R 1987	CHIP RES.	2.2k	1/16W	0.5%	RR0510P-222-D	J24189127		1-	B	c3
R 1988	CHIP RES.	220k	1/10W	5%	RMC1/10T 224J	J24205224		18		
RB1501	BLOCK RES.				MNR04M0ABJ102	J42900039		1-	A	A4
RB1502	BLOCK RES.				MNR04M0ABJ102	J42900039		1-	A	A4
RB1503	BLOCK RES.				MNR04M0ABJ102	J42900039		1-	A	A4
RB1504	BLOCK RES.				MNR04M0ABJ102	J42900039		1-	A	A4
RB1505	BLOCK RES.				MNR04M0ABJ102	J42900039		1-	A	B4
RB1506	BLOCK RES.				MNR04M0ABJ102	J42900039		1-	A	B4
RB1507	BLOCK RES.				MNR04M0ABJ102	J42900039		1-	A	A4
RB1508	BLOCK RES.				MNR04M0ABJ102	J42900039		1-	A	A5
RB1509	BLOCK RES.				MNR04M0ABJ102	J42900039		1-	A	A5
RB1510	BLOCK RES.				MNR04M0ABJ102	J42900039		1-	A	A5
RB1511	BLOCK RES.				MNR04M0ABJ102	J42900039		1-	A	A5
RB1512	BLOCK RES.				MNR04M0ABJ102	J42900039		1-	A	B4
RB1513	BLOCK RES.				MNR04M0ABJ102	J42900039		1-	A	B5
RB1515	BLOCK RES.				MNR04M0ABJ102	J42900039		1-	A	B5
RB1516	BLOCK RES.				MNR04M0ABJ102	J42900039		1-	A	B5
RB1517	BLOCK RES.				MNR04M0ABJ102	J42900039		1-	A	B5
RB1518	BLOCK RES.				MNR04M0ABJ102	J42900039		1-	A	A6
RB1519	BLOCK RES.				MNR04M0ABJ102	J42900039		1-	A	A6
RB1520	BLOCK RES.				MNR04M0ABJ102	J42900039		1-	A	B6
RL1501	RELAY		DC12V		G6E-134P-US DC12V	M1190068		1-	A	F3
RL1502	RELAY		DC12V		AGP2013F DC12V	M1190198		1-	A	E2
RL1503	RELAY		DC12V		G6E-134P-US DC12V	M1190068		1-	A	F3
S 1501	SLIDE SWITCH				SSSS820201	N6090107		1-	A	A6
TH1501	THERMISTOR				NTCG164BH103JT1	G9090190		1-	A	C4

MAIN Unit

Parts List

REF	DESCRIPTION	VALUE	V/W	TOL.	MFR'S DESIG	YAESU P/N	VERS.	LOT	SIDE	LAY ADR
TH1502	THERMISTOR				NTCG164BH103JT1	G9090190		1-	B	b3
TH1503	THERMISTOR				NTCG164BH103JT1	G9090190		1-	A	D3
X 1502	VCTCXO	15.6MHz			TTS14VSB-A3 15.60MHZ	H9501310		1-	B	c5
X 1503	XTAL VT-200				32.768KHZ 20PPM/6PF	H0103267		1-	B	f6
X 1504	XTAL U4B	12.288MHz			12.288MHZ	H0103411		1-	B	g5
XF1001	XTAL FILTER				47R15A9 47.250MHZ	H1102400		1-	A	D4
XF1002	XTAL FILTER				47R15A9 47.250MHZ	H1102400		1-	A	D4
	SPACER				(5X5)	RA1564100		1-		
	SHEET				(11X20)	RA6001900		1-		
	ThermalConductivePad				(11172)	RA1577800		1-		
	ThermalConductivePad					RA6005100		1-		
	ThermalConductivePad				(151515)	RA1565900		1-		
	ThermalConductivePad				(151505)	RA6062400		4-		
	SHEET				(102004)	RA6016200		1-		

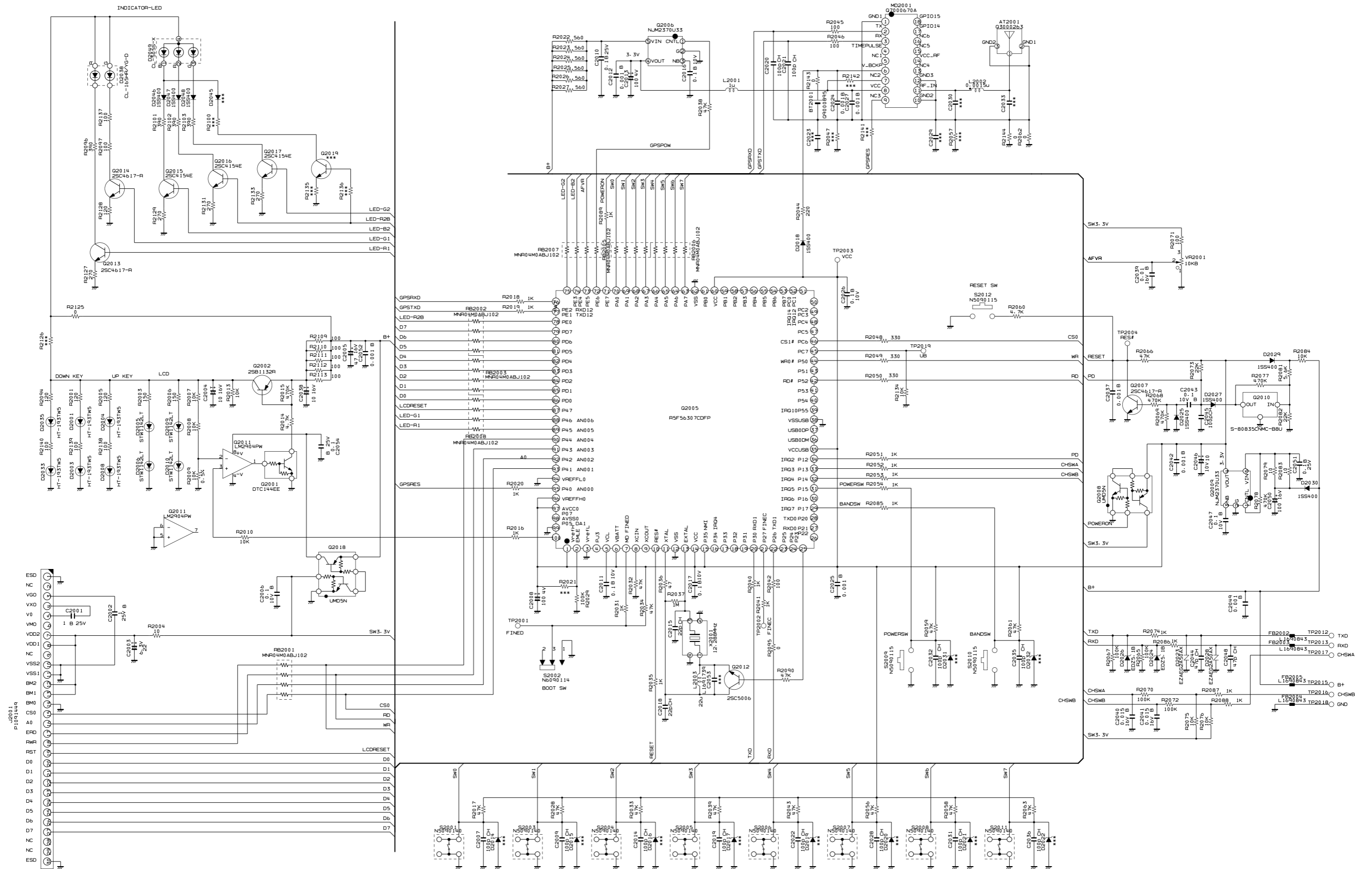

PANEL-1

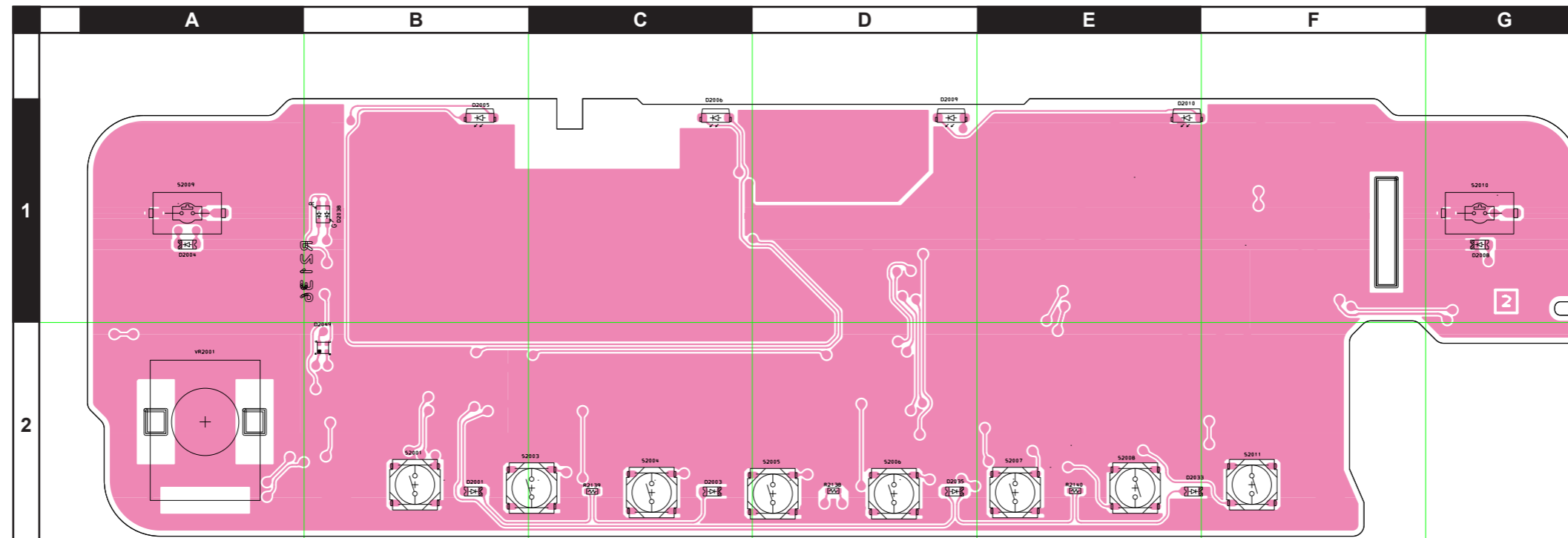

Side A

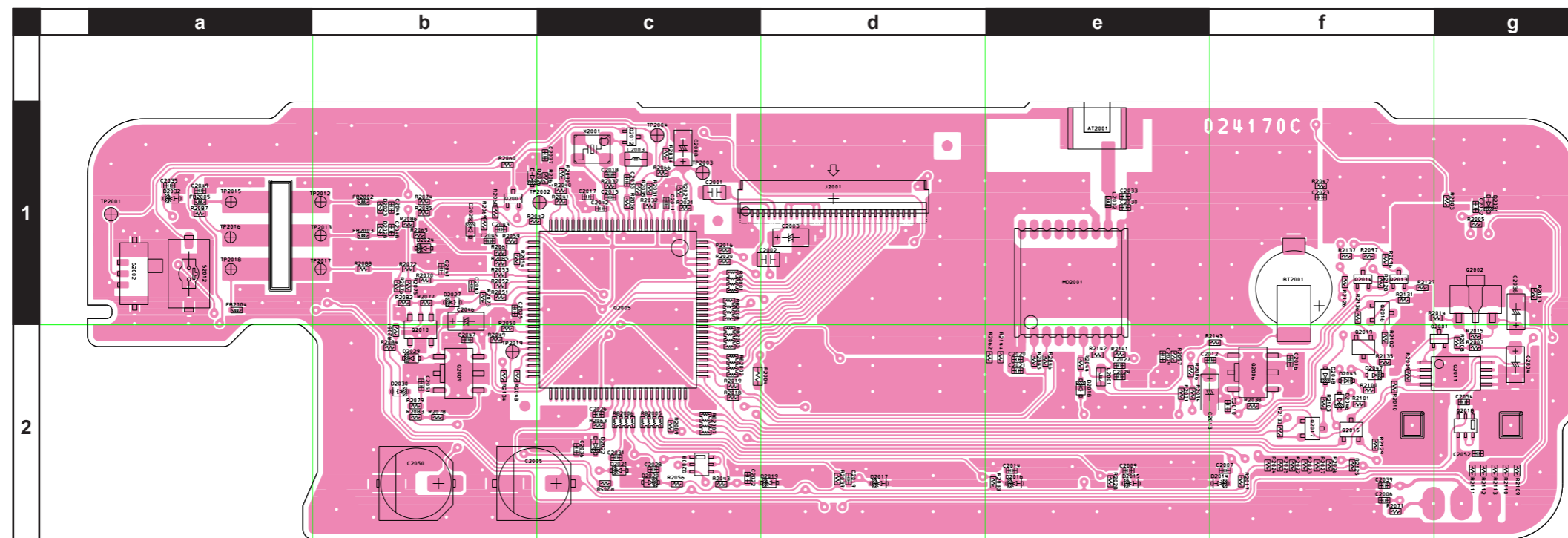

Side B

PANEL Unit

Parts List

REF	DESCRIPTION	VALUE	V/W	TOL.	MFR'S DESIG	YAESU P/N	VERS.	LOT	SIDE	LAY ADR
PCB with Components is included PANEL ASSY (see Exploded View)										
AT2001	CHIP ANTENNA				ACD-5036-A3-CC-S	Q3000263		1-	B	e1
BT2001	LITHIUM BATT.				ML614R-TT31	Q9000895		1-	B	f1
C 2001	CHIP CAP.	1uF	25V	B	GRM21BB31E105KA98L	K22140826		1-	B	c1
C 2002	CHIP CAP.	1uF	25V	B	GRM21BB31E105KA98L	K22140826		1-	B	d1
C 2003	CHIP TA.CAP.	22uF	6.3V		TAJA226M006Y	K78080086		1-	B	d1
C 2003	CHIP TA.CAP.	22uF	6.3V		TAJA226M006RNJ	K78080142		26-	B	d1
C 2004	CHIP TA.CAP.	10uF	16V		TMCMA1C106MTRF	K78120077		1-	B	g2
C 2005	AL.ELECTRO.CAP.	47uF	16V		RV4-16V470MF46-RR2	K48120019		1-	B	b2
C 2006	CHIP CAP.	0.1uF	10V	B	GRM155B11A104KA01D	K22108802		1-	B	f2
C 2007	CHIP CAP.	100pF	50V	CH	GRM1552C1H101JA01D	K22178236		1-	B	f2
C 2008	CHIP TA.CAP.	100uF	4V		TMCMA0G107MTRF	K78060051		1-	B	c1
C 2009	CHIP CAP.	100pF	50V	CH	GRM1552C1H101JA01D	K22178236		1-	B	e2
C 2010	CHIP CAP.	0.1uF	25V	B	GRM155B31E104KA87D	K22148838		1-	B	f2
C 2011	CHIP CAP.	0.1uF	10V	B	GRM155B11A104KA01D	K22108802		1-	B	c1
C 2012	CHIP CAP.	0.001uF	50V	B	GRM155B11H102KA01D	K22178809		1-	B	f2
C 2013	CHIP TA.CAP.	100uF	4V		TMCMA0G107MTRF	K78060051		1-	B	f2
C 2014	CHIP CAP.	100pF	50V	CH	GRM1552C1H101JA01D	K22178236		1-	B	e2
C 2015	CHIP CAP.	22pF	50V	CH	GRM1552C1H220JA01D	K22178220		1-	B	c1
C 2016	CHIP CAP.	0.1uF	10V	B	GRM155B11A104KA01D	K22108802		1-	B	f2
C 2017	CHIP CAP.	0.1uF	10V	B	GRM155B11A104KA01D	K22108802		1-	B	c1
C 2018	CHIP CAP.	22pF	50V	CH	GRM1552C1H220JA01D	K22178220		1-	B	c1
C 2019	CHIP CAP.	100pF	50V	CH	GRM1552C1H101JA01D	K22178236		1-	B	d2
C 2020	CHIP CAP.	100pF	50V	CH	GRM1552C1H101JA01D	K22178236		1-	B	e2
C 2021	CHIP CAP.	100pF	50V	CH	GRM1552C1H101JA01D	K22178236		1-	B	e2
C 2022	CHIP CAP.	100pF	50V	CH	GRM1552C1H101JA01D	K22178236		1-	B	c2
C 2024	CHIP CAP.	0.001uF	50V	B	GRM155B11H102KA01D	K22178809		1-	B	e2
C 2025	CHIP CAP.	0.001uF	50V	B	GRM155B11H102KA01D	K22178809		1-	B	b1
C 2026	CHIP CAP.	0.1uF	10V	B	GRM155B11A104KA01D	K22108802		1-	B	c2
C 2027	CHIP CAP.	0.001uF	50V	B	GRM155B11H102KA01D	K22178809		1-	B	e2
C 2028	CHIP CAP.	100pF	50V	CH	GRM1552C1H101JA01D	K22178236		1-	B	c2
C 2031	CHIP CAP.	100pF	50V	CH	GRM1552C1H101JA01D	K22178236		1-	B	c2
C 2032	CHIP CAP.	100pF	50V	CH	GRM1552C1H101JA01D	K22178236		1-	B	g1
C 2035	CHIP CAP.	100pF	50V	CH	GRM1552C1H101JA01D	K22178236		1-	B	a1
C 2036	CHIP CAP.	100pF	50V	CH	GRM1552C1H101JA01D	K22178236		1-	B	c2
C 2037	CHIP CAP.	0.001uF	50V	B	GRM155B11H102KA01D	K22178809		1-	B	c1
C 2038	CHIP TA.CAP.	10uF	16V		TMCMA1C106MTRF	K78120077		1-	B	g1
C 2039	CHIP CAP.	0.01uF	16V	B	EMK105B103K-F	K22128802		1-	B	f2
C 2040	CHIP CAP.	0.015uF	16V	B	GRM155B11C153KA01D	K22128807		1-	B	b1
C 2041	CHIP CAP.	0.015uF	16V	B	GRM155B11C153KA01D	K22128807		1-	B	b1
C 2042	CHIP CAP.	0.001uF	50V	B	GRM155B11H102KA01D	K22178809		1-	B	c1
C 2043	CHIP CAP.	0.1uF	10V	B	GRM155B11A104KA01D	K22108802		1-	B	b1
C 2044	CHIP CAP.	47pF	50V	CH	GRM1552C1H470JA01D	K22178228		1-	B	b1
C 2045	CHIP CAP.	100pF	50V	CH	GRM1552C1H101JA01D	K22178236		1-	B	b1
C 2046	CHIP TA.CAP.	10uF	10V		TAJA106M010Y	K78100072		1-	B	b1
C 2046	CHIP TA.CAP.	10uF	10V		TAJA106M010RNJ	K78100120		26-	B	b1
C 2047	CHIP CAP.	0.1uF	10V	B	GRM155B11A104KA01D	K22108802		1-	B	b2
C 2048	CHIP CAP.	47pF	50V	CH	GRM1552C1H470JA01D	K22178228		1-	B	b1
C 2049	CHIP CAP.	0.001uF	50V	B	GRM155B11H102KA01D	K22178809		1-	B	a1
C 2050	AL.ELECTRO.CAP.	100uF	16V		EEE1CA101WP	K48120012		1-	B	b2
C 2051	CHIP CAP.	0.1uF	25V	B	GRM155B31E104KA87D	K22148838		1-	B	b2
C 2052	CHIP CAP.	0.001uF	50V	B	GRM155B11H102KA01D	K22178809		1-	B	g2
C 2054	CHIP CAP.	0.1uF	25V	B	GRM155B31E104KA87D	K22148838		1-	B	g2
D 2001	LED				HT-193TW5	G2071390		1-	A	B2
D 2003	LED				HT-193TW5	G2071390		1-	A	C2
D 2004	LED				HT-193TW5	G2071390		1-	A	A1
D 2005	LED				STW1142LT	G2071468		1-	A	B1
D 2006	LED				STW1142LT	G2071468		1-	A	C1
D 2008	LED				HT-193TW5	G2071390		1-	A	G1
D 2009	LED				STW1142LT	G2071468		1-	A	D1
D 2010	LED				STW1142LT	G2071468		1-	A	E1
D 2018	DIODE				1SS400 TE61	G2070634		1-	B	e2
D 2023	SURGE ABSORBER				EZAEG2A50AX	Q9000868		1-	B	b1
D 2024	DIODE				EDZV T2R 5.1B	G2070998		1-	B	b1
D 2025	DIODE				1SS400 TE61	G2070634		1-	B	b1
D 2026	DIODE				EDZV T2R 5.1B	G2070998		1-	B	b1
D 2027	DIODE				1SS400 TE61	G2070634		1-	B	b1
D 2028	SURGE ABSORBER				EZAEG2A50AX	Q9000868		1-	B	b1
D 2029	DIODE				1SS400 TE61	G2070634		1-	B	b2
D 2030	DIODE				1SS400 TE61	G2070634		1-	B	b2
D 2033	LED				HT-193TW5	G2071390		1-	A	E2
D 2035	LED				HT-193TW5	G2071390		1-	A	D2
D 2038	LED				CL-505S-X-SD-T	G4070020		1	A	B1

PANEL Unit

Parts List

REF	DESCRIPTION	VALUE	V/W	TOL.	MFR'S DESIG	YAESU P/N	VERS.	LOT	SIDE	LAY ADR
D 2038	LED				CL-505S-X-SD-T	G2071562		2-	A	B1
D 2046	DIODE				1SS400 TE61	G2070634		1-	B	f2
D 2047	DIODE				1SS400 TE61	G2070634		1-	B	f2
D 2048	DIODE				1SS400 TE61	G2070634		1-	B	f2
D 2049	LED				CL-505S-X-SD-T	G4070020		1	A	B2
D 2049	LED				CL-505S-X-SD-T	G2071562		2-	A	B2
FB2002	FERRITE BEADS				BLM15AG121SN1D	L1690843		1-	B	b1
FB2003	FERRITE BEADS				BLM15AG121SN1D	L1690843		1-	B	b1
FB2004	FERRITE BEADS				BLM15AG121SN1D	L1690843		1-	B	a1
FB2005	FERRITE BEADS				BLM15AG121SN1D	L1690843		1-	B	a1
J 2001	CONNECTOR				FH34S-30S-0.5SH(50)	P1091449		1-	B	d1
L 2001	M.RFC	1uH			LK1608 1R0K-T	L1690687		1-	B	e2
L 2002	M.RFC	0.0015uH		0.3nH	HK1005 1N5S-T	L1691800		1-	B	e1
L 2003	M.RFC	22uH			LB2012T220K	L1691739		1-	B	c1
MD2001	GPS MODULE				MC-1010-Y	Q7000670A		1-	B	e1
Q 2001	TRANSISTOR				DTC144EE TL	G3070075		1-	B	g2
Q 2002	TRANSISTOR				2SB1132 T100 R	G3211327R		1-	B	g1
Q 2005	IC				R5F56307CDFP	G1095027		1-	B	c1
Q 2006	IC				NJM2370U33-TE1	G1094564		1-	B	f2
Q 2007	TRANSISTOR				2SC4617 TL R	G3346178R		1-	B	b1
Q 2008	TRANSISTOR				UMD5N TR	G3070343		1-	B	c2
Q 2009	IC				NJM2370U33-TE1	G1094564		1-	B	b2
Q 2010	IC				S-80835CNMC-B8U-T2-G	G1093606		1-	B	b2
Q 2011	IC				LM2904PWR	G1094010		1-	B	g2
Q 2012	TRANSISTOR				2SC5006-T1-A/YFB	G3350068		1-	B	c1
Q 2013	TRANSISTOR				2SC4617 TL R	G3346178R		1-	B	f1
Q 2014	TRANSISTOR				2SC4617 TL R	G3346178R		1-	B	f1
Q 2015	TRANSISTOR				2SC4154-T111-1E	G3341548E		1-	B	f2
Q 2016	TRANSISTOR				2SC4154-T111-1E	G3341548E		1-	B	f1
Q 2017	TRANSISTOR				2SC4154-T111-1E	G3341548E		1-	B	f2
Q 2018	TRANSISTOR				UMD5N TR	G3070343		1-	B	g2
R 2001	CHIP RES.	120	1/16W	5%	RMC1/16S 121JTH	J24189014		1-	B	e2
R 2003	CHIP RES.	150	1/16W	5%	RMC1/16S 151JTH	J24189015		1-	B	g1
R 2004	CHIP RES.	10	1/16W	5%	RMC1/16 100JATP	J24185100		1-	B	c2
R 2005	CHIP RES.	120	1/16W	5%	RMC1/16S 121JTH	J24189014		1-	B	g1
R 2006	CHIP RES.	150	1/16W	5%	RMC1/16S 151JTH	J24189015		1-	B	e2
R 2007	CHIP RES.	10k	1/16W	5%	RMC1/16S 103JTH	J24189037		1-	B	g2
R 2008	CHIP RES.	10k	1/16W	5%	RMC1/16S 103JTH	J24189037		1-	B	g2
R 2009	CHIP RES.	10k	1/16W	0.5%	RR0510P-103-D	J24189143		1-	B	f2
R 2010	CHIP RES.	10k	1/16W	5%	RMC1/16S 103JTH	J24189037		1-	B	f2
R 2013	CHIP RES.	10k	1/16W	5%	RMC1/16S 103JTH	J24189037		1-	B	g1
R 2014	CHIP RES.	4.7k	1/16W	5%	RMC1/16S 472JTH	J24189033		1-	B	g1
R 2015	CHIP RES.	470k	1/16W	5%	RMC1/16S 474JTH	J24189057		1-	B	g2
R 2016	CHIP RES.	1k	1/16W	5%	RMC1/16S 102JTH	J24189025		1-	B	c1
R 2017	CHIP RES.	47k	1/16W	5%	RMC1/16S 473JTH	J24189045		1-	B	f2
R 2018	CHIP RES.	1k	1/16W	5%	RMC1/16S 102JTH	J24189025		1-	B	c2
R 2019	CHIP RES.	1k	1/16W	5%	RMC1/16S 102JTH	J24189025		1-	B	c2
R 2020	CHIP RES.	1k	1/16W	5%	RMC1/16S 102JTH	J24189025		1-	B	c1
R 2022	CHIP RES.	560	1/16W	5%	RMC1/16S 561JTH	J24189022		1-	B	f2
R 2023	CHIP RES.	560	1/16W	5%	RMC1/16S 561JTH	J24189022		1-	B	f2
R 2024	CHIP RES.	560	1/16W	5%	RMC1/16S 561JTH	J24189022		1-	B	f2
R 2025	CHIP RES.	560	1/16W	5%	RMC1/16S 561JTH	J24189022		1-	B	f2
R 2026	CHIP RES.	560	1/16W	5%	RMC1/16S 561JTH	J24189022		1-	B	f2
R 2027	CHIP RES.	560	1/16W	5%	RMC1/16S 561JTH	J24189022		1-	B	f2
R 2028	CHIP RES.	47k	1/16W	5%	RMC1/16S 473JTH	J24189045		1-	B	e2
R 2029	CHIP RES.	100k	1/16W	5%	RMC1/16S 104JTH	J24189049		1-	B	c1
R 2031	CHIP RES.	1k	1/16W	5%	RMC1/16S 102JTH	J24189025		1-	B	c1
R 2032	CHIP RES.	47k	1/16W	5%	RMC1/16S 473JTH	J24189045		1-	B	c1
R 2033	CHIP RES.	47k	1/16W	5%	RMC1/16S 473JTH	J24189045		1-	B	e2
R 2034	CHIP RES.	47k	1/16W	5%	RMC1/16S 473JTH	J24189045		1-	B	c1
R 2035	CHIP RES.	1k	1/16W	5%	RMC1/16S 102JTH	J24189025		1-	B	c1
R 2036	CHIP RES.	47	1/16W	5%	RMC1/16S 470JTH	J24189009		1-	B	c1
R 2037	CHIP RES.	1M	1/16W	5%	RMC1/16S 105JTH	J24189061		1-	B	c1
R 2038	CHIP RES.	47k	1/16W	5%	RMC1/16S 473JTH	J24189045		1-	B	f2
R 2039	CHIP RES.	47k	1/16W	5%	RMC1/16S 473JTH	J24189045		1-	B	d2
R 2040	CHIP RES.	1k	1/16W	5%	RMC1/16S 102JTH	J24189025		1-	B	c1
R 2041	CHIP RES.	1k	1/16W	5%	RMC1/16S 102JTH	J24189025		1-	B	c1
R 2042	CHIP RES.	100	1/16W	5%	RMC1/16S 101JTH	J24189013		1-	B	b1
R 2043	CHIP RES.	47k	1/16W	5%	RMC1/16S 473JTH	J24189045		1-	B	c2
R 2044	CHIP RES.	220	1/16W	5%	RMC1/16S 221JTH	J24189017		1-	B	e2
R 2045	CHIP RES.	100	1/16W	5%	RMC1/16S 101JTH	J24189013		1-	B	e2
R 2046	CHIP RES.	100	1/16W	5%	RMC1/16S 101JTH	J24189013		1-	B	e2
R 2048	CHIP RES.	330	1/16W	5%	RMC1/16S 331JTH	J24189019		1-	B	b2

PANEL Unit

Parts List

REF	DESCRIPTION	VALUE	V/W	TOL.	MFR'S DESIG	YAESU P/N	VERS.	LOT	SIDE	LAY ADR
R 2049	CHIP RES.	330	1/16W	5%	RMC1/16S 331JTH	J24189019		1-	B	b2
R 2050	CHIP RES.	330	1/16W	5%	RMC1/16S 331JTH	J24189019		1-	B	b2
R 2051	CHIP RES.	1k	1/16W	5%	RMC1/16S 102JTH	J24189025		1-	B	b1
R 2052	CHIP RES.	1k	1/16W	5%	RMC1/16S 102JTH	J24189025		1-	B	b1
R 2053	CHIP RES.	1k	1/16W	5%	RMC1/16S 102JTH	J24189025		1-	B	b1
R 2054	CHIP RES.	1k	1/16W	5%	RMC1/16S 102JTH	J24189025		1-	B	b1
R 2056	CHIP RES.	47k	1/16W	5%	RMC1/16S 473JTH	J24189045		1-	B	c2
R 2058	CHIP RES.	47k	1/16W	5%	RMC1/16S 473JTH	J24189045		1-	B	c2
R 2059	CHIP RES.	47k	1/16W	5%	RMC1/16S 473JTH	J24189045		1-	B	b1
R 2060	CHIP RES.	4.7k	1/16W	5%	RMC1/16S 472JTH	J24189033		1-	B	b1
R 2061	CHIP RES.	47k	1/16W	5%	RMC1/16S 473JTH	J24189045		1-	B	b1
R 2062	CHIP RES.	0	1/16W	5%	RMC1/16S JPTH	J24189070		1-	B	e2
R 2063	CHIP RES.	47k	1/16W	5%	RMC1/16S 473JTH	J24189045		1-	B	c2
R 2065	CHIP RES.	100k	1/16W	5%	RMC1/16S 104JTH	J24189049		1-	B	b1
R 2066	CHIP RES.	47k	1/16W	5%	RMC1/16S 473JTH	J24189045		1-	B	c1
R 2067	CHIP RES.	100k	1/16W	5%	RMC1/16S 104JTH	J24189049		1-	B	c1
R 2068	CHIP RES.	470k	1/16W	5%	RMC1/16S 474JTH	J24189057		1-	B	b1
R 2069	CHIP RES.	470k	1/16W	5%	RMC1/16S 474JTH	J24189057		1-	B	b1
R 2070	CHIP RES.	100k	1/16W	5%	RMC1/16S 104JTH	J24189049		1-	B	b1
R 2071	CHIP RES.	100	1/16W	5%	RMC1/16S 101JTH	J24189013		1-	B	f2
R 2072	CHIP RES.	100k	1/16W	5%	RMC1/16S 104JTH	J24189049		1-	B	b1
R 2073	CHIP RES.	22k	1/16W	5%	RMC1/16S 223JTH	J24189041		1-	B	b1
R 2074	CHIP RES.	1k	1/16W	5%	RMC1/16S 102JTH	J24189025		1-	B	b1
R 2075	CHIP RES.	10k	1/16W	5%	RMC1/16S 103JTH	J24189037		1-	B	b1
R 2076	CHIP RES.	10k	1/16W	5%	RMC1/16S 103JTH	J24189037		1-	B	b1
R 2077	CHIP RES.	470k	1/16W	5%	RMC1/16S 474JTH	J24189057		1-	B	b1
R 2078	CHIP RES.	470k	1/16W	5%	RMC1/16S 474JTH	J24189057		1-	B	b2
R 2079	CHIP RES.	10	1/16W	5%	RMC1/16S 100JTH	J24189001		1-	B	b2
R 2081	CHIP RES.	5.6k	1/16W	5%	RMC1/16S 562JTH	J24189034		1-	B	b2
R 2082	CHIP RES.	22k	1/16W	5%	RMC1/16S 223JTH	J24189041		1-	B	b1
R 2083	CHIP RES.	10	1/16W	5%	RMC1/16S 100JTH	J24189001		1-	B	b2
R 2084	CHIP RES.	10k	1/16W	5%	RMC1/16S 103JTH	J24189037		1-	B	b2
R 2085	CHIP RES.	1k	1/16W	5%	RMC1/16S 102JTH	J24189025		1-	B	b1
R 2086	CHIP RES.	1k	1/16W	5%	RMC1/16S 102JTH	J24189025		1-	B	b1
R 2087	CHIP RES.	1k	1/16W	5%	RMC1/16S 102JTH	J24189025		1-	B	a1
R 2088	CHIP RES.	1k	1/16W	5%	RMC1/16S 102JTH	J24189025		1-	B	b1
R 2089	CHIP RES.	1k	1/16W	5%	RMC1/16S 102JTH	J24189025		1-	B	c2
R 2090	CHIP RES.	47k	1/16W	5%	RMC1/16S 473JTH	J24189045		1-	B	c1
R 2094	CHIP RES.	120	1/16W	5%	RMC1/16S 121JTH	J24189014		1-	B	e2
R 2095	CHIP RES.	0	1/16W	5%	RMC1/16S JPTH	J24189070		1-	B	b1
R 2096	CHIP RES.	820	1/16W	5%	RMC1/16S 821JTH	J24189024		1-	B	f1
R 2097	CHIP RES.	470	1/16W	5%	RMC1/16S 471JTH	J24189021		1-	B	f1
R 2101	CHIP RES.	680	1/16W	5%	RMC1/16S 681JTH	J24189023		1-	B	f2
R 2102	CHIP RES.	470	1/16W	5%	RMC1/16S 471JTH	J24189021		1-	B	f2
R 2103	CHIP RES.	680	1/16W	5%	RMC1/16S 681JTH	J24189023		1-	B	f2
R 2109	CHIP RES.	100	1/16W	5%	RMC1/16S 101JTH	J24189013		1-	B	g2
R 2110	CHIP RES.	100	1/16W	5%	RMC1/16S 101JTH	J24189013		1-	B	g2
R 2111	CHIP RES.	100	1/16W	5%	RMC1/16S 101JTH	J24189013		1-	B	g2
R 2112	CHIP RES.	100	1/16W	5%	RMC1/16S 101JTH	J24189013		1-	B	g2
R 2113	CHIP RES.	100	1/16W	5%	RMC1/16S 101JTH	J24189013		1-	B	g2
R 2125	CHIP RES.	0	1/16W	5%	RMC1/16S JPTH	J24189070		1-	B	f2
R 2127	CHIP RES.	470	1/16W	5%	RMC1/16S 471JTH	J24189021		1-	B	f1
R 2128	CHIP RES.	330	1/16W	5%	RMC1/16S 331JTH	J24189019		1-	B	f1
R 2129	CHIP RES.	470	1/16W	5%	RMC1/16S 471JTH	J24189021		1-	B	f2
R 2131	CHIP RES.	330	1/16W	5%	RMC1/16S 331JTH	J24189019		1-	B	f1
R 2133	CHIP RES.	470	1/16W	5%	RMC1/16S 471JTH	J24189021		1-	B	f2
R 2134	CHIP RES.	10k	1/16W	5%	RMC1/16S 103JTH	J24189037		1-	B	b2
R 2137	CHIP RES.	100	1/16W	5%	RMC1/16S 101JTH	J24189013		1-	B	f1
R 2138	CHIP RES.	100	1/16W	5%	RMC1/16S 101JTH	J24189013		1-	A	D2
R 2139	CHIP RES.	100	1/16W	5%	RMC1/16S 101JTH	J24189013		1-	A	C2
R 2140	CHIP RES.	100	1/16W	5%	RMC1/16S 101JTH	J24189013		1-	A	E2
R 2143	CHIP RES.	0	1/16W	5%	RMC1/16S JPTH	J24189070		1-	B	f2
R 2144	CHIP RES.	0	1/16W	5%	RMC1/16S JPTH	J24189070		1-	B	e2
RB2001	BLOCK RES.				MNR04M0ABJ102	J42900039		1-	B	c1
RB2002	BLOCK RES.				MNR04M0ABJ102	J42900039		1-	B	c2
RB2003	BLOCK RES.				MNR04M0ABJ102	J42900039		1-	B	c2
RB2005	BLOCK RES.				MNR04M0ABJ102	J42900039		1-	B	c2
RB2006	BLOCK RES.				MNR04M0ABJ102	J42900039		1-	B	c2
RB2007	BLOCK RES.				MNR04M0ABJ102	J42900039		1-	B	c2
RB2008	BLOCK RES.				MNR04M0ABJ102	J42900039		1-	B	c1
S 2001	TACT SWITCH				SKRMAAE010	N5090140		1-	A	B2
S 2002	SLIDE SWITCH				SSAJ120100	N6090114		1-	B	a1
S 2003	TACT SWITCH				SKRMAAE010	N5090140		1-	A	B2

PANEL SUB Unit

Circuit Diagram

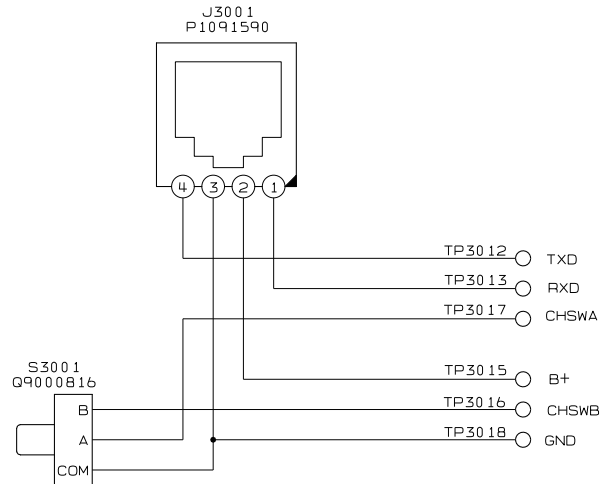

Parts Layout

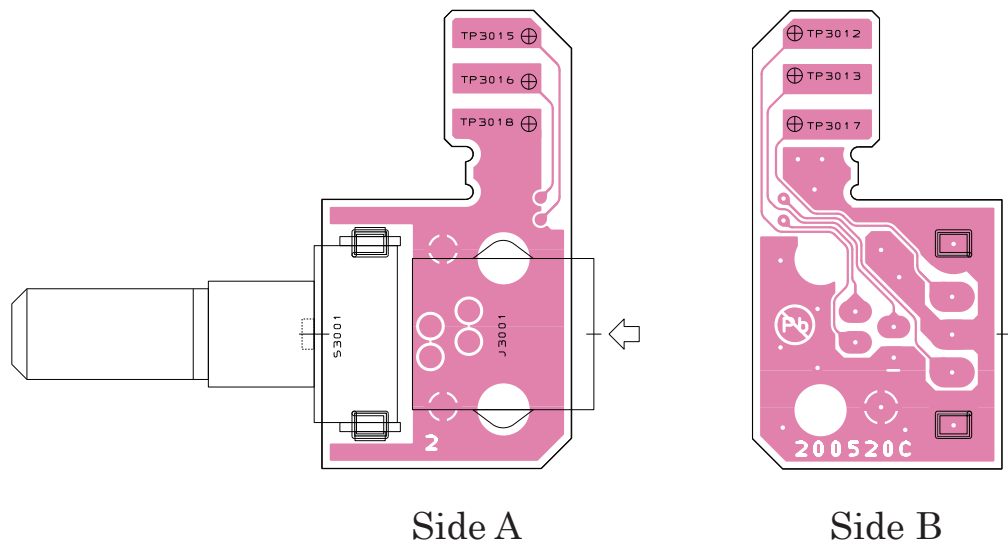

Parts List

REF	DESCRIPTION	VALUE	V/W	TOL.	MFR'S DESIG	YAESU P/N	VERS.	LOT	SIDE	LAY ADR
PCB with Components is included PANEL-SUB-UNIT (see Exploded View)										
J 3001	CONNECTOR				616PCB4-E	P1091590		1-	A	
S 3001	ROTARY ENCODER				EC11B15202	Q9000816		1-	A	

DSP Unit Circuit Diagram

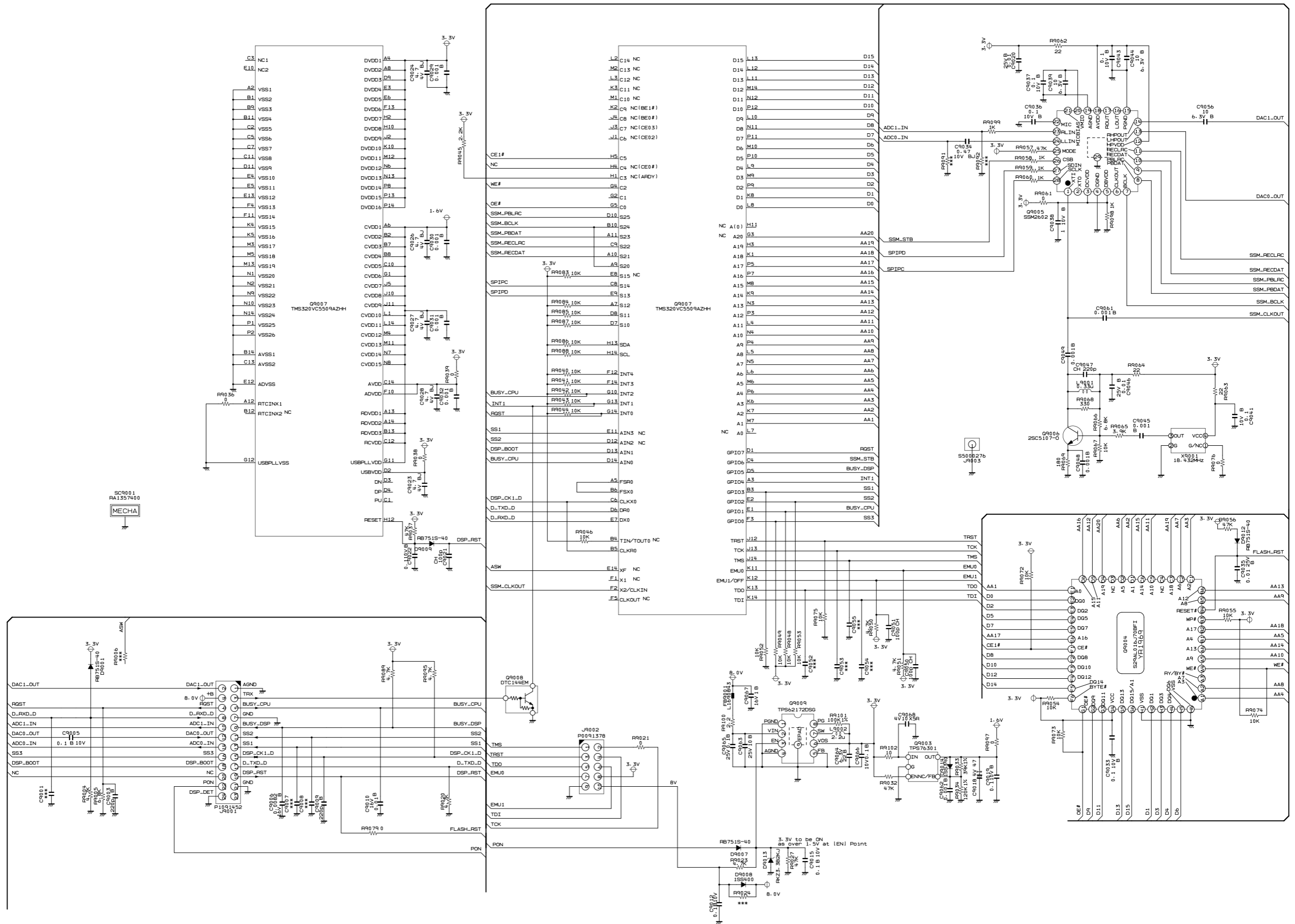

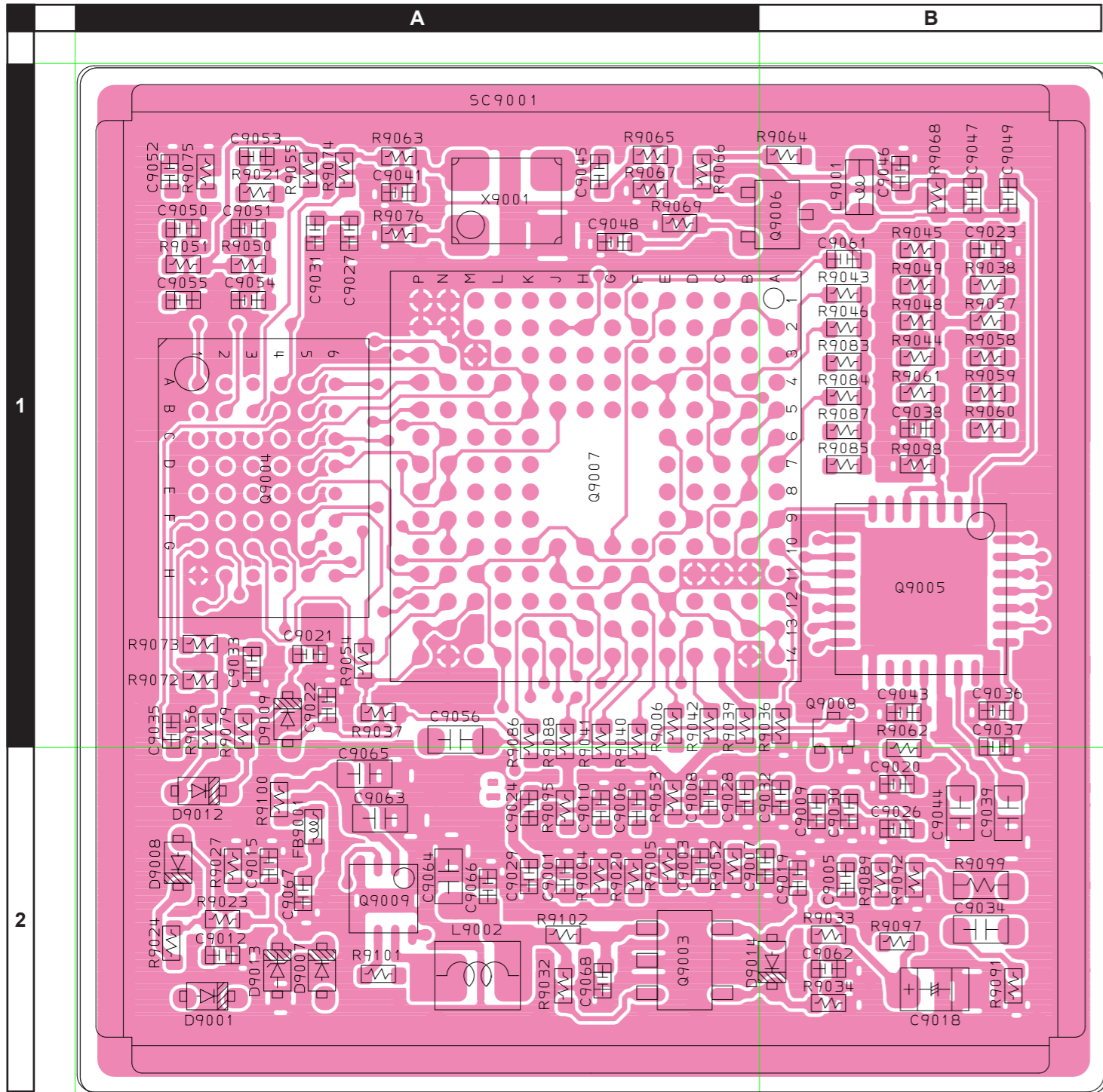

Side A

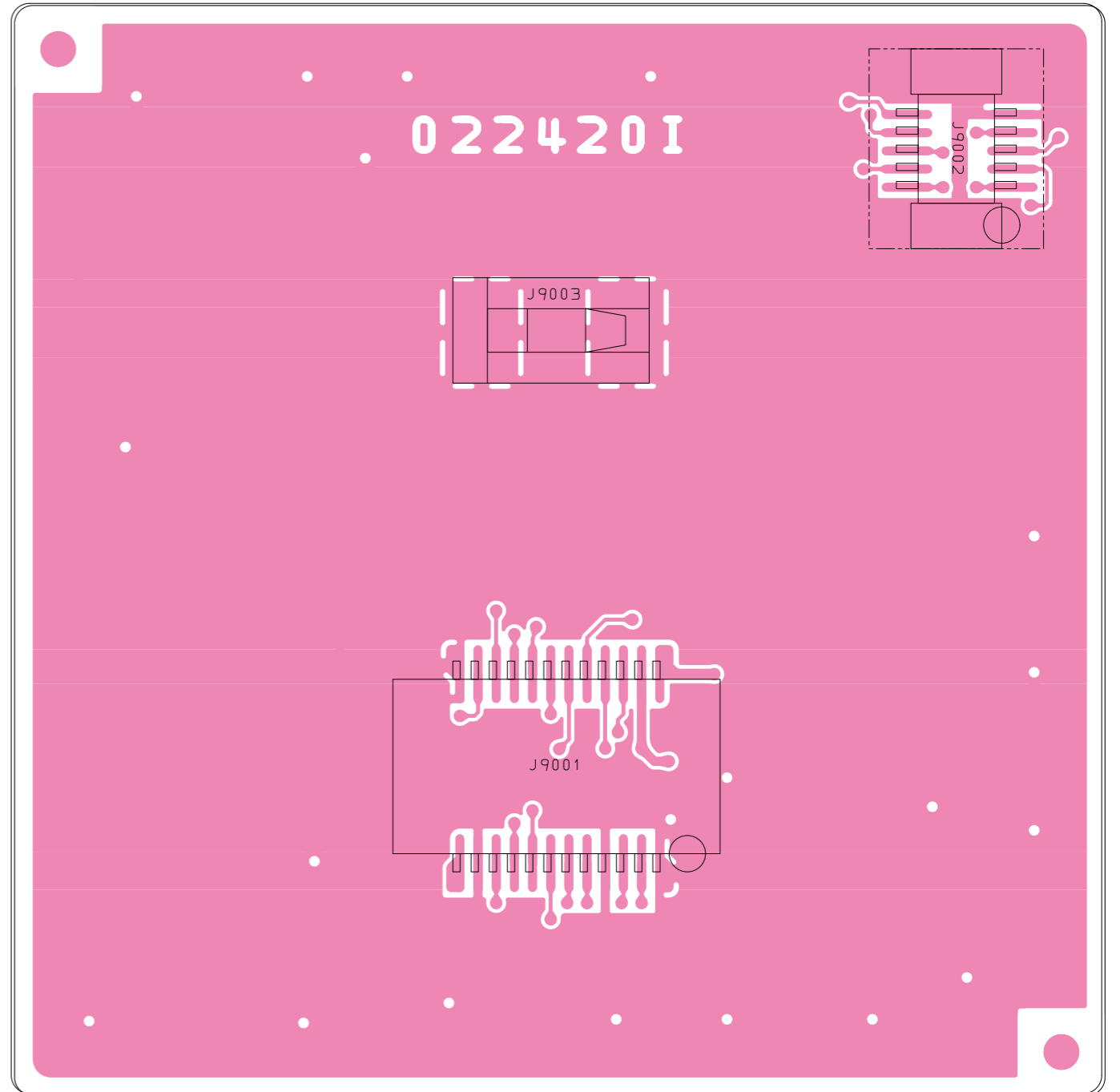

Side B

DSP Unit

Parts List

REF	DESCRIPTION	VALUE	V/W	TOL.	MFR'S DESIG	YAESU P/N	VERS.	LOT	SIDE	LAY ADR
PCB with Components is included DSP ASSY (see Exploded View)										
C 9003	CHIP CAP.	220pF	50V	B	GRM155B11H221KA01D	K22178801		1-	A	A2
C 9005	CHIP CAP.	0.1uF	10V	B	GRM155B11A104KA01D	K22108802		1-	A	B2
C 9006	CHIP CAP.	0.0082uF	16V	B	GRM155B11C822KA01D	K22128801		1-	A	A2
C 9009	CHIP CAP.	220pF	50V	B	GRM155B11H221KA01D	K22178801		1-	A	B2
C 9010	CHIP CAP.	0.01uF	16V	B	GRM155B11C103JA01D	K22128814		1-	A	A2
C 9012	CHIP CAP.	0.1uF	10V	B	GRM155B11A104KA01D	K22108802		1-	A	A2
C 9015	CHIP CAP.	0.1uF	10V	B	GRM155B11A104KA01D	K22108802		1-	A	A2
C 9018	CHIP TA.CAP.	47uF	4V		TMCP0G476MTRF	K78060050		1-	A	B2
C 9019	CHIP CAP.	0.1uF	10V	B	GRM155B11A104KA01D	K22108802		1-	A	B2
C 9020	CHIP CAP.	0.01uF	25V	B	GRM155B11E103KA01D	K22148834		1-	A	B2
C 9021	CHIP CAP.	100pF	50V	CH	GRM1552C1H101JA01D	K22178236		1-	A	A1
C 9022	CHIP CAP.	0.1uF	10V	B	GRM155B11A104KA01D	K22108802		1-	A	A1
C 9023	CHIP CAP.	4.7uF	4V	BJ	AMK105BJ475MV-F	K22068801		1-	A	B1
C 9024	CHIP CAP.	4.7uF	4V	BJ	AMK105BJ475MV-F	K22068801		1-	A	A2
C 9026	CHIP CAP.	4.7uF	4V	BJ	AMK105BJ475MV-F	K22068801		1-	A	B2
C 9027	CHIP CAP.	4.7uF	4V	BJ	AMK105BJ475MV-F	K22068801		1-	A	A1
C 9028	CHIP CAP.	4.7uF	4V	BJ	AMK105BJ475MV-F	K22068801		1-	A	A2
C 9029	CHIP CAP.	0.001uF	50V	B	GRM155B11H102KA01D	K22178809		1-	A	A2
C 9030	CHIP CAP.	0.001uF	50V	B	GRM155B11H102KA01D	K22178809		1-	A	B2
C 9031	CHIP CAP.	0.001uF	50V	B	GRM155B11H102KA01D	K22178809		1-	A	A1
C 9032	CHIP CAP.	0.001uF	50V	B	GRM155B11H102KA01D	K22178809		1-	A	B2
C 9033	CHIP CAP.	0.1uF	10V	B	GRM155B11A104KA01D	K22108802		1-	A	A1
C 9034	CHIP CAP.	0.47uF	10V	BJ	LMK107BJ474KA-T	K22104803		1-	A	B2
C 9035	CHIP CAP.	0.01uF	25V	B	GRM155B11E103KA01D	K22148834		1-	A	A1
C 9036	CHIP CAP.	0.1uF	10V	B	GRM155B11A104KA01D	K22108802		1-	A	B1
C 9037	CHIP CAP.	0.1uF	10V	B	GRM155B11A104KA01D	K22108802		1-	A	B1
C 9038	CHIP CAP.	1uF	10V	B	GRM155B31A105KE15D	K22108809		1-	A	B1
C 9039	CHIP CAP.	10uF	6.3V	B	JMK107BJ106MA-T	K22084806		1-	A	B2
C 9041	CHIP CAP.	0.1uF	10V	B	GRM155B11A104KA01D	K22108802		1-	A	A1
C 9043	CHIP CAP.	0.1uF	10V	B	GRM155B11A104KA01D	K22108802		1-	A	B1
C 9044	CHIP CAP.	10uF	6.3V	B	JMK107BJ106MA-T	K22084806		1-	A	B2
C 9045	CHIP CAP.	0.001uF	50V	B	GRM155B11H102KA01D	K22178809		1-	A	A1
C 9046	CHIP CAP.	0.01uF	25V	B	GRM155B11E103KA01D	K22148834		1-	A	B1
C 9047	CHIP CAP.	220pF	50V	CH	GRM1552C1H221JA01D	K22179713		1-	A	B1
C 9048	CHIP CAP.	0.001uF	50V	B	GRM155B11H102KA01D	K22178809		1-	A	A1
C 9049	CHIP CAP.	0.001uF	50V	B	GRM155B11H102KA01D	K22178809		1-	A	B1
C 9050	CHIP CAP.	100pF	50V	CH	GRM1552C1H101JA01D	K22178236		1-	A	A1
C 9051	CHIP CAP.	100pF	50V	CH	GRM1552C1H101JA01D	K22178236		1-	A	A1
C 9056	CHIP CAP.	10uF	6.3V	B	JMK107BJ106MA-T	K22084806		1-	A	A1
C 9061	CHIP CAP.	0.001uF	50V	B	GRM155B11H102KA01D	K22178809		1-	A	B1
C 9063	CHIP CAP.	10uF	25V	B	GRM188R61E106MA73D	K22144818		1-	A	A2
C 9064	CHIP CAP.	22uF	6.3V	B	GRM188R60J226MEA0D	K22084807		1-	A	A2
C 9065	CHIP CAP.	0.1uF	25V	B	GRM188B11E104KA01D	K22144814		1-	A	A2
C 9066	CHIP CAP.	0.1uF	10V	B	GRM155B11A104KA01D	K22108802		1-	A	A2
C 9067	CHIP CAP.	1uF	16V	B	GRM155B31C105KA12D	K22128817		1-	A	A2
C 9068	CHIP CAP.	10uF	6.3V	B	JMK107BJ106MA-T	K22084806		19-	A	A2
D 9001	DIODE				RB751S-40TE61	G2070850		1-	A	A2
D 9007	DIODE				RB751S-40TE61	G2070850		1-	A	A2
D 9008	DIODE				1SS400 TE61	G2070634		1-	A	A2
D 9009	DIODE				RB751S-40TE61	G2070850		1-	A	A1
D 9012	DIODE				RB751S-40TE61	G2070850		1-	A	A2
D 9013	DIODE				RKZ3.3B2KJR1	G2071398		1	A	A2
D 9013	DIODE				BZX585C3V3	G2071502		2-	A	A2
FB9001	FERRITE BEADS				BLM15AG121SN1D	L1690843		1-	A	A2
J 9001	CONNECTOR				AXK5F24547YG	P1091452		1-	B	a2
J 9002	CONNECTOR				AXK6F10345YP	P0091378		1-	B	b1
J 9002	CONNECTOR				AXK6F10347YG	P0091558		26-	B	b1
J 9003	SHIELD FINGER				0G-542925	S5000276		1-	B	a1
L 9001	M.RFC	0.33uH			LK1608 R33K-T	L1690412		1-	A	B1
L 9002	M.RFC	2.2uH		20%	LQH2HPN2R2MG0L	L1691811		1-	A	A2
L 9002	M.RFC	2.2uH		20%	LQH2HPN2R2MGRL	L1691988		27-	A	A2
Q 9003	IC				TPS76301DBVR	G1094152		1-	A	A2
Q 9004	IC				S29AL016J70BFI010E	×		1-	A	A1
Q 9004	IC				S29AL016J70BFI010E	×		10-	A	A1
Q 9005	IC				SSM2602CPZ-REEL7	G1094762		1-	A	B1
Q 9006	TRANSISTOR				2SC5107-O(TE85R.F)	G33510770		1-	A	B1
Q 9007	IC				TMS320VC5509AZHH	G1094763		1-	A	A1
Q 9008	TRANSISTOR				DTC144EM T2L	G3070309		1-	A	B1
Q 9009	IC				TPS62172DSGR	G1095062		1-	A	A2
R 9004	CHIP RES.	4.7k	1/16W	5%	RMC1/16S 472JTH	J24189033		1-	A	A2
R 9005	CHIP RES.	6.8k	1/16W	5%	RMC1/16S 682JTH	J24189035		1-	A	A2
R 9020	CHIP RES.	4.7k	1/16W	5%	RMC1/16S 472JTH	J24189033		1-	A	A2

* Please Contact YAESU when replacing this part.

DSP Unit

Parts List

REF	DESCRIPTION	VALUE	V/W	TOL.	MFR'S DESIG	YAESU P/N	VERS.	LOT	SIDE	LAY ADR
R 9021	CHIP RES.	0	1/16W	5%	RMC1/16S JPTH	J24189070		1-	A	A1
R 9023	CHIP RES.	4.7k	1/16W	5%	RMC1/16S 472JTH	J24189033		1-	A	A2
R 9027	CHIP RES.	47k	1/16W	5%	RMC1/16S 473JTH	J24189045		1-	A	A2
R 9032	CHIP RES.	47k	1/16W	5%	RMC1/16S 473JTH	J24189045		1-	A	A2
R 9033	CHIP RES.	39k	1/16W	1%	RMC1/16SK393FTH	J24189524		1-	A	B2
R 9034	CHIP RES.	120k	1/16W	1%	RMC1/16SK124FTH	J24189530		1-	A	B2
R 9036	CHIP RES.	0	1/16W	5%	RMC1/16S JPTH	J24189070		1-	A	B1
R 9037	CHIP RES.	47k	1/16W	5%	RMC1/16S 473JTH	J24189045		1-	A	A1
R 9038	CHIP RES.	0	1/16W	5%	RMC1/16S JPTH	J24189070		1-	A	B1
R 9039	CHIP RES.	0	1/16W	5%	RMC1/16S JPTH	J24189070		1-	A	A1
R 9040	CHIP RES.	10k	1/16W	5%	RMC1/16S 103JTH	J24189037		1-	A	A1
R 9041	CHIP RES.	10k	1/16W	5%	RMC1/16S 103JTH	J24189037		1-	A	A1
R 9042	CHIP RES.	10k	1/16W	5%	RMC1/16S 103JTH	J24189037		1-	A	A1
R 9043	CHIP RES.	10k	1/16W	5%	RMC1/16S 103JTH	J24189037		1-	A	B1
R 9044	CHIP RES.	10k	1/16W	5%	RMC1/16S 103JTH	J24189037		1-	A	B1
R 9045	CHIP RES.	2.2k	1/16W	5%	RMC1/16S 222JTH	J24189029		1-	A	B1
R 9046	CHIP RES.	10k	1/16W	5%	RMC1/16S 103JTH	J24189037		1-	A	B1
R 9048	CHIP RES.	10k	1/16W	5%	RMC1/16S 103JTH	J24189037		1-	A	B1
R 9049	CHIP RES.	10k	1/16W	5%	RMC1/16S 103JTH	J24189037		1-	A	B1
R 9050	CHIP RES.	4.7k	1/16W	5%	RMC1/16S 472JTH	J24189033		1-	A	A1
R 9051	CHIP RES.	4.7k	1/16W	5%	RMC1/16S 472JTH	J24189033		1-	A	A1
R 9052	CHIP RES.	10k	1/16W	5%	RMC1/16S 103JTH	J24189037		1-	A	A2
R 9053	CHIP RES.	10k	1/16W	5%	RMC1/16S 103JTH	J24189037		1-	A	A2
R 9054	CHIP RES.	10k	1/16W	5%	RMC1/16S 103JTH	J24189037		1-	A	A1
R 9055	CHIP RES.	10k	1/16W	5%	RMC1/16S 103JTH	J24189037		1-	A	A1
R 9056	CHIP RES.	47k	1/16W	5%	RMC1/16S 473JTH	J24189045		1-	A	A1
R 9057	CHIP RES.	47k	1/16W	5%	RMC1/16S 473JTH	J24189045		1-	A	B1
R 9058	CHIP RES.	1k	1/16W	5%	RMC1/16S 102JTH	J24189025		1-	A	B1
R 9059	CHIP RES.	1k	1/16W	5%	RMC1/16S 102JTH	J24189025		1-	A	B1
R 9060	CHIP RES.	1k	1/16W	5%	RMC1/16S 102JTH	J24189025		1-	A	B1
R 9061	CHIP RES.	0	1/16W	5%	RMC1/16S JPTH	J24189070		1-	A	B1
R 9062	CHIP RES.	22	1/16W	5%	RMC1/16S 220JTH	J24189005		1-	A	B1
R 9063	CHIP RES.	22	1/16W	5%	RMC1/16S 220JTH	J24189005		1-	A	A1
R 9064	CHIP RES.	22	1/16W	5%	RMC1/16S 220JTH	J24189005		1-	A	B1
R 9065	CHIP RES.	3.9k	1/16W	5%	RMC1/16S 392JTH	J24189032		1-	A	A1
R 9066	CHIP RES.	6.8k	1/16W	5%	RMC1/16S 682JTH	J24189035		1-	A	A1
R 9067	CHIP RES.	10k	1/16W	5%	RMC1/16S 103JTH	J24189037		1-	A	A1
R 9068	CHIP RES.	330	1/16W	5%	RMC1/16S 331JTH	J24189019		1-	A	B1
R 9069	CHIP RES.	180	1/16W	5%	RMC1/16S 181JTH	J24189016		1-	A	A1
R 9072	CHIP RES.	10k	1/16W	5%	RMC1/16S 103JTH	J24189037		1-	A	A1
R 9073	CHIP RES.	10k	1/16W	5%	RMC1/16S 103JTH	J24189037		1-	A	A1
R 9074	CHIP RES.	10k	1/16W	5%	RMC1/16S 103JTH	J24189037		1-	A	A1
R 9075	CHIP RES.	10k	1/16W	5%	RMC1/16S 103JTH	J24189037		1-	A	A1
R 9076	CHIP RES.	0	1/16W	5%	RMC1/16S JPTH	J24189070		1-	A	A1
R 9079	CHIP RES.	0	1/16W	5%	RMC1/16S JPTH	J24189070		1-	A	A1
R 9083	CHIP RES.	10k	1/16W	5%	RMC1/16S 103JTH	J24189037		1-	A	B1
R 9084	CHIP RES.	10k	1/16W	5%	RMC1/16S 103JTH	J24189037		1-	A	B1
R 9085	CHIP RES.	10k	1/16W	5%	RMC1/16S 103JTH	J24189037		1-	A	B1
R 9086	CHIP RES.	10k	1/16W	5%	RMC1/16S 103JTH	J24189037		1-	A	A1
R 9087	CHIP RES.	10k	1/16W	5%	RMC1/16S 103JTH	J24189037		1-	A	B1
R 9088	CHIP RES.	10k	1/16W	5%	RMC1/16S 103JTH	J24189037		1-	A	A1
R 9089	CHIP RES.	4.7k	1/16W	5%	RMC1/16S 472JTH	J24189033		1-	A	B2
R 9095	CHIP RES.	4.7k	1/16W	5%	RMC1/16S 472JTH	J24189033		1-	A	A2
R 9097	CHIP RES.	0	1/16W	5%	RMC1/16S JPTH	J24189070		1-	A	B2
R 9098	CHIP RES.	1k	1/16W	5%	RMC1/16S 102JTH	J24189025		1-	A	B1
R 9099	CHIP RES.	1k	1/16W	5%	RMC1/16 102JATP	J24185102		1-18	A	B2
R 9100	CHIP RES.	2.2	1/16W	5%	RMC1/16S 2R2JTH	J24189602		1-	A	A2
R 9101	CHIP RES.	100k	1/16W	1%	RMC1/16SK104FTH	J24189529		1-	A	A2
R 9102	CHIP RES.	0	1/16W	5%	RMC1/16S JPTH	J24189070		1-	A	A2
SC9001	SHIELD CASE				(DSP)	RA1357400		1-	A	A1
X 9001	TCXO	18.432MHz			TTS18NSE-A11 18.432M	H9501220		1-	A	A1



Copyright 2019
YAESU MUSEN CO., LTD.
All rights reserved.

No portion of this manual may be
reproduced without the permission of
YAESU MUSEN CO., LTD.

YAESU MUSEN CO., LTD.

Tennozu Parkside Building
2-5-8 Higashi-Shinagawa, Shinagawa-ku, Tokyo 140-0002 Japan

YAESU USA

6125 Phyllis Drive, Cypress, CA 90630, U.S.A.

YAESU UK

Unit 12, Sun Valley Business Park, Winnall Close
Winchester, Hampshire, SO23 0LB, U.K.