



FM TRANSCEIVER

FT-2800M

Technical Supplement

©2003 VERTEX STANDARD CO., LTD.

EH014N90A

VERTEX STANDARD CO., LTD.
 4-8-8 Nakameguro, Meguro-Ku, Tokyo 153-8644, Japan

VERTEX STANDARD
US Headquarters
 10900 Walker Street, Cypress, CA 90630, U.S.A.
International Division
 8350 N.W. 52nd Terrace, Suite 201, Miami, FL 33166, U.S.A.

YAESU EUROPE B.V.
 P.O. Box 75525, 1118 ZN Schiphol, The Netherlands

YAESU UK LTD.
 Unit 12, Sun Valley Business Park, Winnall Close
 Winchester, Hampshire, SO23 0LB, U.K.

VERTEX STANDARD HK LTD.
 Unit 5, 20/F., Seaview Centre, 139-141 Hoi Bun Road,
 Kwun Tong, Kowloon, Hong Kong

Downloaded by
RadioAmateur.EU

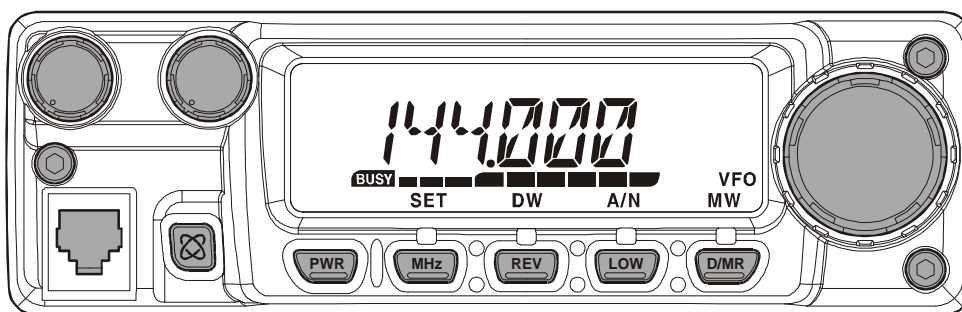

Introduction

This manual provides technical information necessary for servicing the FT-2800M FM Transceiver.

Servicing this equipment requires expertise in handling surface-mount chip components. Attempts by non-qualified persons to service this equipment may result in permanent damage not covered by the warranty, and may be illegal in some countries.

Two PCB layout diagrams are provided for each double-sided circuit board in the Transceiver. Each side of is referred to by the type of the majority of components installed on that side (“leaded” or “chip-only”). In most cases one side has only chip components, and the other has either a mixture of both chip and leaded components (trimmers, coils, electrolytic capacitors, ICs, etc.), or leaded components only.

While we believe the technical information in this manual to be correct, VERTEX STANDARD assumes no liability for damage that may occur as a result of typographical or other errors that may be present. Your cooperation in pointing out any inconsistencies in the technical information would be appreciated.

Contents

Specifications.....	2	Board Unit (Schematics, Layouts & Parts)	
Exploded View & Miscellaneous Parts	3	μCOM Unit /RF Unit Circuit Diagram	13
Block Diagram	5	μCOM Unit Parts Layout	15
Circuit Description	7	μCOM Unit Parts List	17
Alignment	9	RF Unit Parts Layout	21
		RF Unit Parts List	23

Specifications

General

Frequency Range:	Tx 144 - 146 MHz or 144 - 148 MHz Rx 144 - 146 MHz or 137 - 174 MHz
Channel Step:	5/10/12.5/15/20/25/50/100 kHz
Standard Repeater Shift:	±600 kHz
Frequency Stability:	Better than ±10 ppm [-4 °F to +140 °F (-20 °C to +60 °C)]
Modes of Emission:	F2/F3
Antenna Impedance:	50 Ohms, unbalanced
Supply voltage:	13.8 V DC ±15%, negative ground
Current Consumption (typical):	Rx: less than 0.7 A, less than 0.3 A (squelched) Tx: 10 A (65 W)/7 A (25 W)/5 A (10 W)/4 A (5 W)
Operating Temperature Range:	-4° F to +140° F (-20° C to +60° C)
Case Size (WxHxD):	6.3" x 2.0" x 7.3" (160 x 50 x 185 mm) (w/o knobs)
Weight (Approx.):	4.0 lb (1.8 kg)

Transmitter

Output Power:	65 W/25 W/10 W/5 W
Modulation Type:	Variable Reactance
Maximum Deviation:	±5 kHz/±2.5 kHz
Spurious Radiation:	Better than -60 dB
Microphone Impedance:	2000 Ohms

Receiver

Circuit Type:	Double Conversion Superheterodyne
IFs:	21.7 MHz & 450 kHz
Sensitivity (for 12dB SINAD):	Better than 0.2 µV
Selectivity (-6/-60dB):	12 kHz/28 kHz
IF Rejection:	Better than 70 dB
Image Rejection:	Better than 70 dB
Maximum AF Output:	3 W into 4 Ohms @10 % THD

Specifications subject to change without notice or obligation. Specifications guaranteed only within Amateur band

**Downloaded by
RadioAmateur.EU**

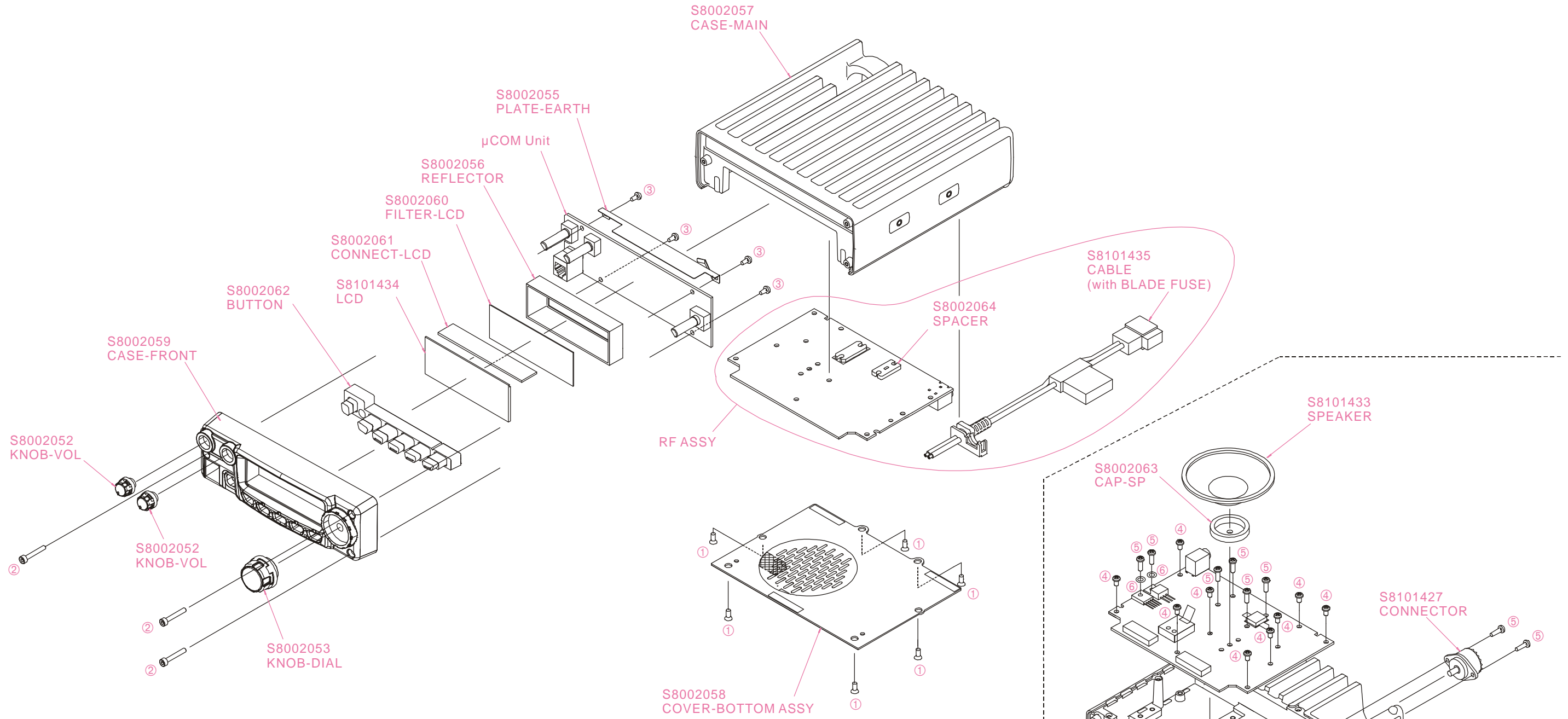

Screw List			
REF.	VXSTD P/N	Description	Qty.
①	U30308007	FLAT HEAD SCREW M3x8B	6
②	S8002065	BOLT CAP M3x20 BZC	3
③	S8002066	TAPTITE SCREW 3x8ZC	4
④	U44306001	TAPTITE SCREW M3x6	9
⑤	S8002067	TAPTITE SCREW 3x10ZC	8
⑥	S8002068	WASHER-PLAIN	2

Accessories	
Description	VXSTD P/N
FOOT	S8002050
BRACKET	S8002051
BLADE FUSE ATC 15A	Q0000075
CABLE ND-A35-2500CB	S8101436
MIC MH48A6J	AAA43X001

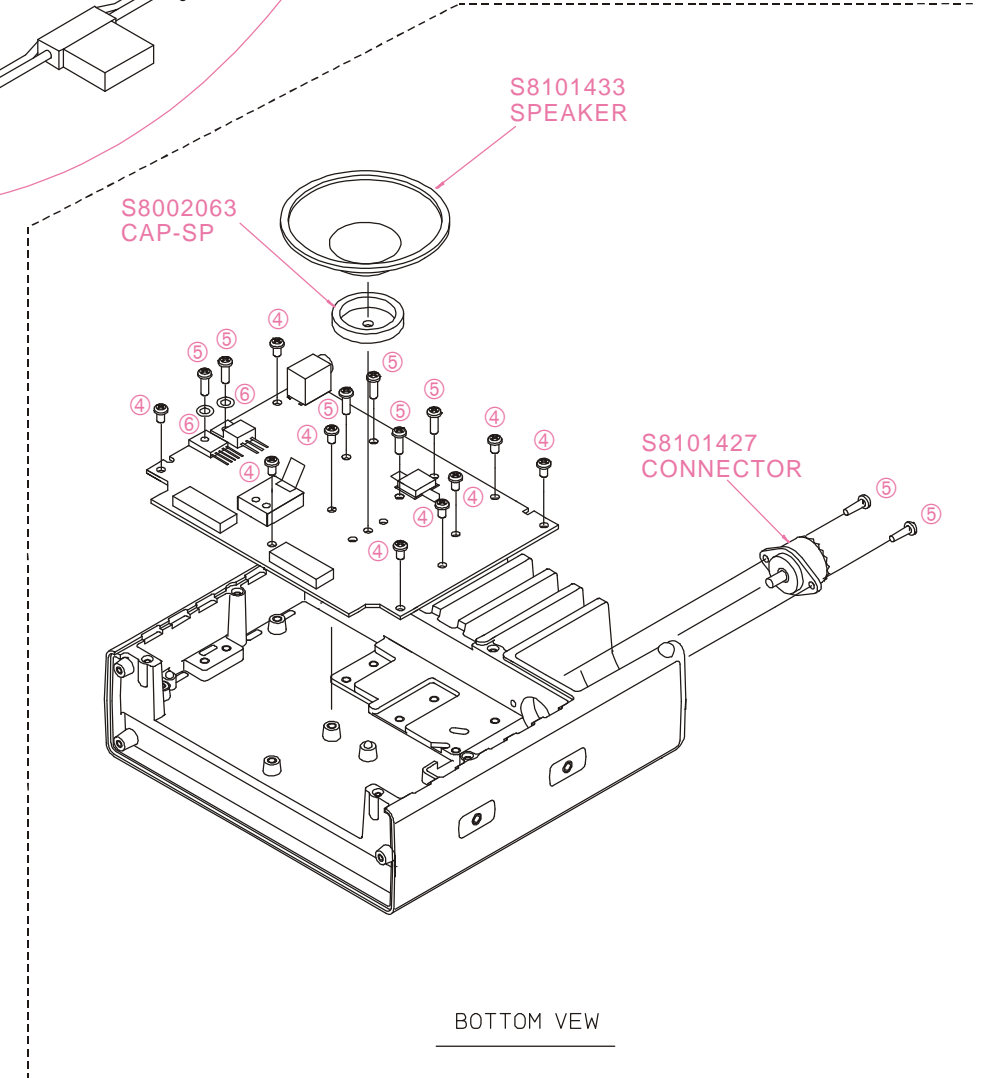

BOTTOM VIEW

Exploded View & Miscellaneous Parts

Note

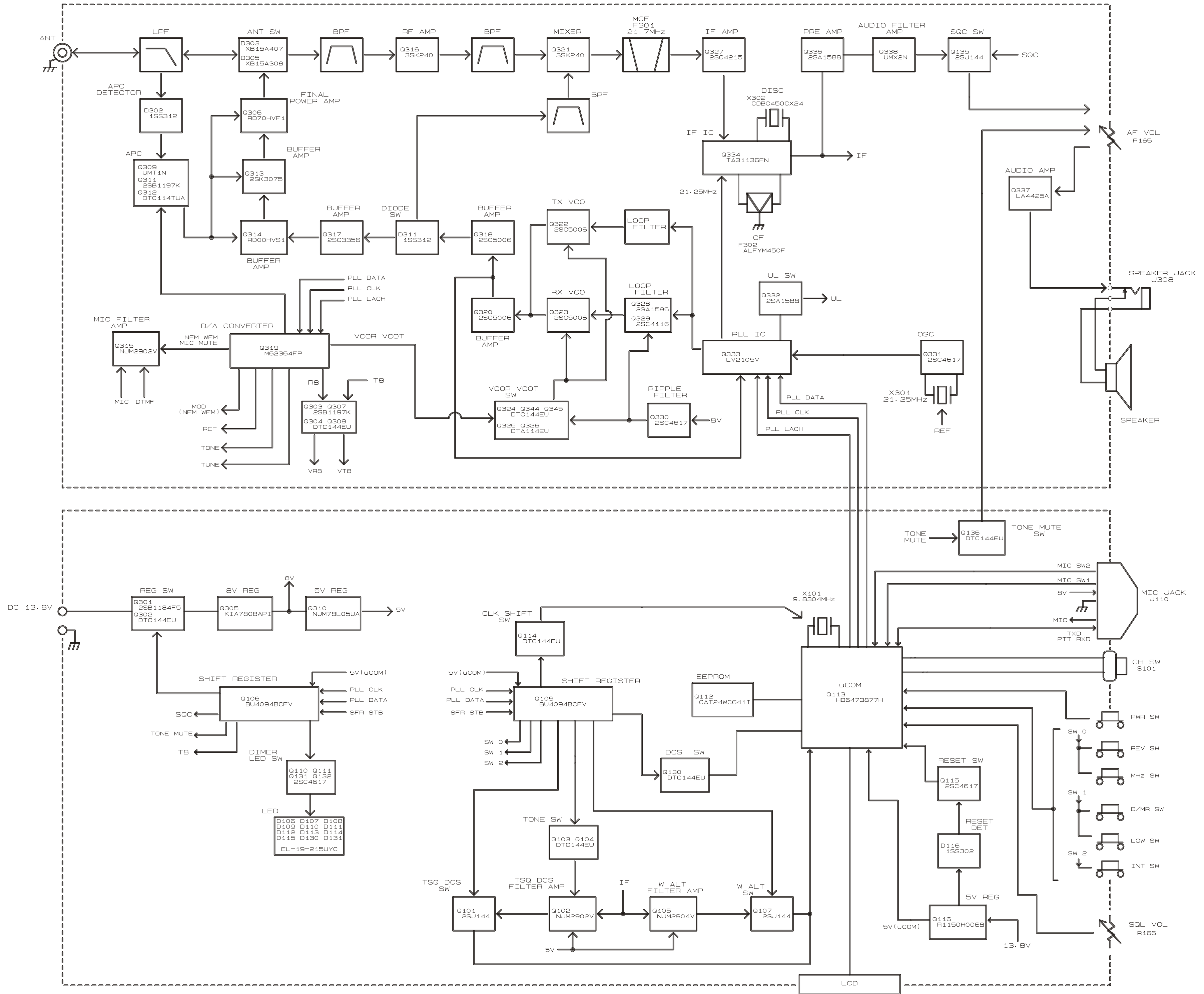

Block Diagram

Note

Circuit Description

Reception and transmission are switched by “RX” and “TX” lines from the microprocessor unit (MPU). The receiver uses double-conversion superheterodyne circuitry, with a 21.7 MHz 1st IF and 450 kHz 2nd IF. The 1st local, produced by a PLL synthesizer, yields the 21.7 MHz 1st IF.

The 2nd local uses a 21.250 MHz (21.7 MHz - 450 kHz) signal generated by a crystal oscillator. The 2nd mixer and other circuits use a custom IC to convert and amplify the 2nd IF, and detect FM to obtain demodulated signals.

During transmit, the PLL synthesizer oscillates at the desired frequency directly, for amplification to obtain RF power output. During transmit, voice modulation and CTCSS (or DCS) modulation are applied to this synthesizer. Transceiver functions, such as TX/RX control, PLL synthesizer settings, and channel programming, are controlled using the MPU.

Receiver

Incoming RF signals from the antenna connector are delivered to the RF Unit, and pass through a lowpass filter (LPF) consisting of coils L303, L305, and L307, capacitors C303, C309, C310, and C316, and antenna switching diodes **D305** and **D306** (Both **MA111**) for delivery to the receiver front end.

Signals within the frequency range of the transceiver are then passed through a varactor-tuned bandpass filter consisting of diodes **D308**, **D322**, **D310** and **D323** (all **HVC3508**), and coils L334, L335, L320 and L322 and associated circuitry before RF amplification by **Q316** (**3SK240**).

The amplified RF signal is then bandpass filtered again by varactor-tuned resonators consisting of diodes **D312**, **D324**, **D313** and **D325** (all **HVC3508**), and coils L336, L337, L325 and L327 and associated circuitry, to ensure pure in-band input to 1st mixer **Q321** (**3SK240**).

Buffered output from the VCO Unit is amplified by **Q318** (**2SC5006**) and lowpass-filtered by L339, C414, and C413, to provide a pure 1st local signal between 112.3 and 152.3 MHz, which is delivered to the 1st mixer.

The 21.7 MHz 1st mixer product then passes through dual monolithic crystal filter F301 (7.5 kHz BW), and is amplified by **Q327** (**2SC4215Y**) and delivered to the input of the FM IF subsystem IC **Q334** (**TA31136FN**).

This IC contains the 2nd mixer, 2nd local oscillator, limiter amplifier, FM detector, noise amplifier, S-meter amplifier and squelch gates.

The 2nd local in the IF-IC is produced from crystal **X302** (21.250 MHz), and the 1st IF is converted to 450 kHz by the 2nd mixer and stripped of unwanted components by ceramic filter **F302**. After passing through a limiter amplifier, the signal is demodulated by the FM detector.

Demodulated receive audio from the IF-IC is amplified by **Q336** (**2SA1588Y**) and **Q338** (**UMX2M**). After volume adjustment by the AF power amplifier **Q337** (**LA4425A**), the audio signal is passed to the optional headphone or 8-ohm loudspeaker.

PLL Synthesizer

The 1st local maintains stability from the PLL synthesizer by using a 21.250 MHz reference signal from crystal **X301**. PLL synthesizer IC **Q333** (**LV2105V**) consists of a prescaler, reference counter, swallow counter, programmable counter, a serial data input port to set these counters based on external data, a phase comparator, and a charge pump.

The PLL-IC divides the 21.250 MHz reference signal by 4,250 using the reference counter (5.0 kHz comparison frequency). The VCO output is divided by the prescaler, swallow counter and programmable counter. These two signals are compared by the phase comparator and applied to the charge pump. A voltage proportional to their phase difference is delivered to the low-pass filter circuit, then fed back to the VCO as a voltage with phase error, controlling and stabilizing the oscillating frequency. This synthesizer also operates as a modulator during transmit.

The RX VCO is comprised of **Q323** (**2SC5006**) and **D314/D326** (Both **1SV282**), and oscillates at 21.7 MHz during receive.

The TX VCO is comprised of **Q322** (**2SC5006**) and **D316/D327** (Both **1SV282**) and oscillates at the fundamental frequency during transmit, with direct frequency-modulation using varactor diode **D315** (**1SV214**).

The VCO output passes through buffer amplifier **Q320** (**2SC5005**), and a portion is fed to the PLL IC, and at the same time is amplified by **Q318** (**2SC5006**) to obtain stable output. Synthesizer output is fed to the 1st mixer by diode switch **D311** (**1SS321**) during receive, and to pre-drive amplifier **Q317** (**2SC3356**) for transmit.

The reference oscillator feeds the PLL synthesizer, and is composed of crystal **X301** (21.250 MHz) and transmit (DCS) modulation circuit **D317** (**HVC350B**).

The VCO DC supply is regulated by **Q330** (**2SC4617**).

Circuit Description

Transmitter

The speech signal from the microphone is delivered via the MIC Jack to the RF Unit; after passing through **Q315 (NJM2902V)** which consists of amplifier, pre-emphasis, limiter (IDC instantaneous deviation control) and lowpass filter, to **Q319 (M6364FP)** which is adjusted for optimum deviation level and delivered to the TX VCO **Q322**.

The speech signal from the microphone and CTCSS are FM modulated by the TX VCO of the synthesizer, while DCS audio is modulated by the reference frequency oscillator of the synthesizer.

Synthesizer output, after passing through diode switch **D311 (1SS321)**, is amplified by pre-drivers **Q317 (2SC3356)** and **Q314 (RD00HVS1)**, driver **Q313 (2SK3075)**, and power amplifier **Q305 (RD70HVS1)** to obtain full RF output. The RF energy then passes through antenna switch **D303 (XB15A407)** and a low-pass filter circuit and finally to the antenna connector.

RF output power from the final amplifier is sampled by

C318 and C324 and is rectified by **D302 (1SS321)**.

The resulting DC is fed through Automatic Power Controller **Q309 (UMT1N)**, **Q312 (DTC114)**, and **Q311 (2SB1197)** to transmitter RF amplifier **Q305** and is used to provide control of the power output.

Generation of spurious products by the transmitter is minimized by the fundamental carrier frequency being equal to the final transmitting frequency, modulated directly in the transmit VCO.

Additionally harmonic suppression is provided by a low-pass filter consisting of L303, L305, C303, C309, C310, and C316, resulting in more than 60 dB of harmonic suppression prior to delivery of the RF

Introduction and Precautions

The FT-2800M has been carefully aligned at the factory for the specified performance at the 144 MHz amateur band. Realignment should therefore not be necessary except in the event of a component failure. All component replacement and service should be performed only by an authorized Vertex Standard representative, or the warranty policy may be voided.

The following procedures cover the sometimes critical and tedious adjustments that are not normally required once the transceiver has left the factory. However, if damage occurs and some parts are replaced, realignment may be required. If a sudden problem occurs during normal operation, it is likely due to component failure; realignment should not be done until after the faulty component has been replaced.

We recommend that servicing be performed only by authorized Vertex Standard service technicians who are experienced with the circuitry and fully equipped for repair and alignment. Therefore, if a fault is suspected, contact the dealer from whom the transceiver was purchased for instructions regarding repair. Authorized Vertex Standard service technicians realign all circuits and make complete performance checks to ensure compliance with factory specifications after replacing any faulty components.

Those who do undertake any of the following alignments are cautioned to proceed at their own risk. Problems caused by unauthorized attempts at realignment are not covered by the warranty policy. Also, Vertex Standard must reserve the right to change circuits and alignment procedures in the interest of improved performance, without notifying owners.

Under no circumstances should any alignment be attempted unless the normal function and operation of the transceiver are clearly understood, the cause of the malfunction has been clearly pinpointed and any faulty components replaced, and the need for realignment determined to be absolutely necessary.

Downloaded by
RadioAmateur.EU

Required Test Equipment

The following test equipment (and thorough familiarity with its correct use) is necessary for complete realignment. Correction of problems caused by misalignment resulting from use of improper test equipment is not covered under the warranty policy. While most steps do not require all of the equipment listed, the interactions of some adjustments may require that more complex adjustments be performed afterwards. Do not attempt to perform only a single step unless it is clearly isolated electrically from all other steps. Have all test equipment ready before beginning, and follow all of the steps in a section in the order presented.

- Regulated DC Power Supply: adjustable from 10 to 17 VDC, 15 A
- RF Signal Generator with calibrated output level at 200 MHz
- Frequency Counter: ± 0.1 ppm accuracy at 200 MHz
- AF Signal Generator
- SINAD Meter
- Deviation Meter (linear detector)
- AF Milivoltmeter
- AF Dummy Load: 8-Ohm, 5 W
- DC Voltmeter: high impedance
- Inline Wattmeter with 5% accuracy at 200 MHz
- 50-Ohm non-reactive Dummy Load:
- 100 watts at 200 MHz
- VHF Sampling Coupler

Set up the test equipment as shown for the transceiver alignment, and apply 13.8 VDC power to the transceiver.

Alignment Preparation & Precautions

A dummy load and inline wattmeter must be connected to the antenna jack in all procedures that call for transmission, except where specified otherwise. Correct alignment is not possible with an antenna. After completing one step, read the following step to determine whether the same test equipment will be required. If not, remove the test equipment (except dummy load and wattmeter, if connected) before proceeding.

Correct alignment requires that the ambient temperature in the repair shop be the same as that of the transceiver and test equipment, and that this temperature be held constant between 68 °C and 86 °F (20 °C ~ 30 °C). When the transceiver is brought into the shop from hot or cold air it should be allowed some time for thermal equalization with the environment before alignment. If possible, alignments should be made with oscillator shields and circuit boards firmly affixed in place. Also, the test equipment must be thoroughly warmed up before beginning.

Notes: Signal levels in dB referred to in alignment are based on 0 dB μ = 0.5 μ V.

Alignment

Entering the Alignment mode

Alignment of the FT-2800M is performed using a front-panel software-based procedure. To perform alignment of the transceiver, it must first be placed in the “Alignment Mode,” in which the adjustments will be made and then stored into memory.

To enter the Alignment mode:

1. Press and hold in the [LOW] key and [D/MR] key while turning the radio on. Once the radio is on, release these two keys.
2. Press and hold the [MHz] key for one second to activate the “Set” (Menu) mode.
3. Rotate the DIAL knob to select “35 D/ASMT,” then press the [MHz] key.
4. You will now note the appearance of “REF” on the display, this signifies that the transceiver is now in the “Alignment mode.”

PLL Reference Frequency (REF)

1. Tune the transceiver to 146.000 MHz.
2. Set the transceiver to Alignment mode, then rotate the DIAL knob to set the Alignment parameter to “REF.”
3. Press the PTT switch to activate the transmitter, and press the [REV] or [D/MR] key, as needed, so that the counter frequency reading is 146.000 MHz.
4. Press and hold the [LOW] key for one second to save the new setting.
5. Press and hold the [MHz] key for one second to exit to the normal operation.

PLL VCO

1. Connect the DC voltmeter to TP-RVC on the RF Unit.
2. Tune the frequency to 146.000 MHz.
3. Adjust L330 on the RF Unit for 1.5 V on the DC voltmeter.
4. Connect the DC voltmeter to TP-TVC on the RF Unit.
5. Press the PTT switch to activate the transmitter, and adjust L329 on the RF Unit for 1.3 V on the DC voltmeter.

RF Front-end Tuning

(TUN137/TUN146/TUN160/TUN173)

1. Connect the DC voltmeter to the Test Point (RSSI: Pin 6 of J307) on the RF Unit.
2. Tune the transceiver to 137.050 MHz.
3. Set the transceiver to Alignment mode, then rotate the DIAL knob to set the Alignment parameter to “TUN137.”
4. Inject a 137.050 MHz signal at a level of $-5 \text{ dB}\mu$ (with 1 kHz modulation @ $\pm 3.5 \text{ kHz}$ deviation) from the RF Signal Generator.
5. Press the [REV] or [D/MR] key for maximum deflection of the DC voltmeter.
6. Press and hold the [LOW] key for one second to save the new setting, then press and hold the [MHz] key for one second to exit to the normal operation.
7. Tune the transceiver to 146.050 MHz.
8. Set the transceiver to Alignment mode, then rotate the DIAL knob to set the Alignment parameter to “TUN146.”

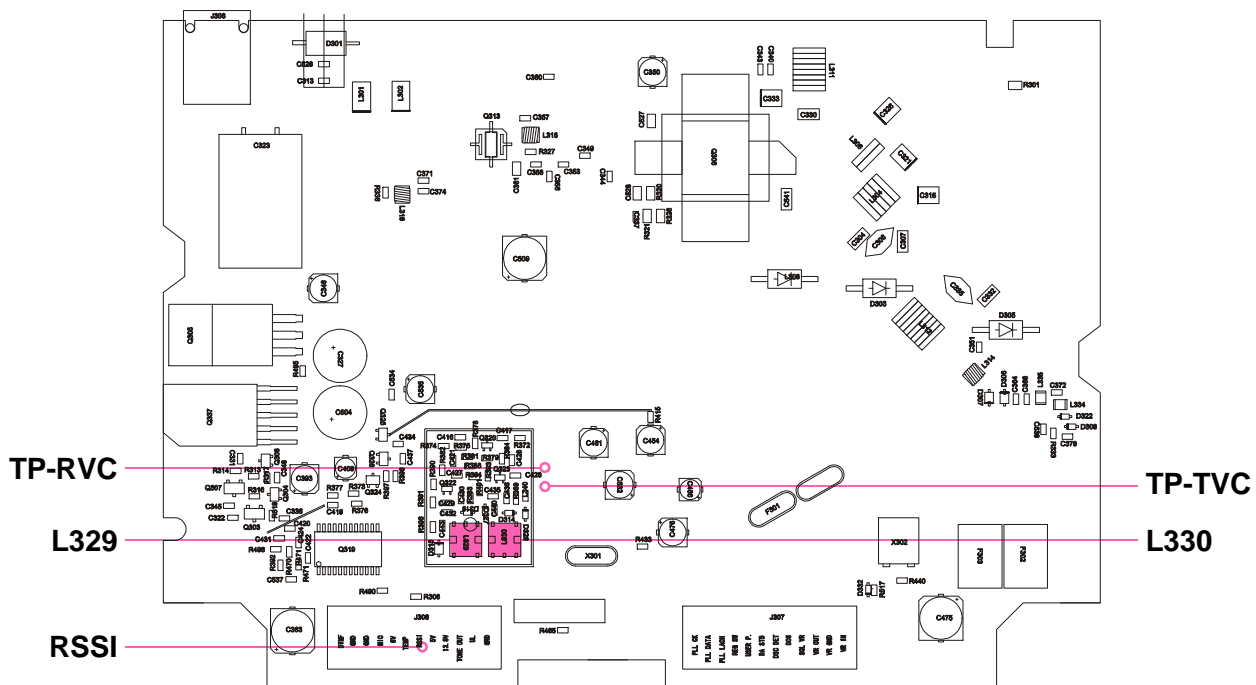

RF UNIT ALIGNMNT POINTS

- Inject a 146.050 MHz signal at a level of $-5 \text{ dB}\mu$ (with 1 kHz modulation @ $\pm 3.5 \text{ kHz}$ deviation) from the RF Signal Generator.
- Press the [REV] or [D/MR] key for maximum deflection of the DC voltmeter and maximum deflection of the SINAD meter.
- Press and hold the [LOW] key for one second to save the new setting, then press and hold the [MHz] key for one second to exit to the normal operation.
- Tune the transceiver to 160.050 MHz.
- Set the transceiver to Alignment mode, then rotate the **DIAL** knob to set the Alignment parameter to “TUN160.”
- Inject a 160.050 MHz signal at a level of $-5 \text{ dB}\mu$ (with 1 kHz modulation @ $\pm 3.5 \text{ kHz}$ deviation) from the RF Signal Generator.
- Press the [REV] or [D/MR] key for maximum deflection of the DC voltmeter at the higher side of the bandpass filter peaks.
- Press and hold the [LOW] key for one second to save the new setting, then press and hold the [MHz] key for one second to exit to the normal operation.
- Tune the transceiver to 173.050 MHz.
- Set the transceiver to Alignment mode, then rotate the **DIAL** knob to set the Alignment parameter to “TUN173.”
- Inject a 173.050 MHz signal at a level of $-5 \text{ dB}\mu$ (with 1 kHz modulation @ $\pm 3.5 \text{ kHz}$ deviation) from the RF Signal Generator.
- Press the [REV] or [D/MR] key for maximum deflection of the DC voltmeter at the higher side of the bandpass filter peaks.
- Press and hold the [LOW] key for one second to save the new setting, then press and hold the [MHz] key for one second to exit to the normal operation.

S-Meter Sensitivity (SMTL 10/SMTL 2)

- Set the transceiver to Alignment mode, then rotate the **DIAL** knob to set the Alignment parameter to “SMTL 10.”
- Inject a 146.050 MHz signal at a level of $+25 \text{ dB}\mu$ (with 1 kHz modulation @ $\pm 3.5 \text{ kHz}$ deviation) from the RF Signal Generator.
- Press and hold the [LOW] key for one second to save the new setting.
- Rotate the **DIAL** knob one click to clockwise to set the Alignment parameter to “SMTL 2.”
- Reduce the RF Signal Generator output level to $-5 \text{ dB}\mu$.
- Press and hold the [LOW] key for one second to save the new setting.

- Press and hold the [MHz] key for one second to exit to the normal operation.

TX Power Output

(TXPW H/TXPW M/TXPW L2/TXPW L1)

- Tune the transceiver to 146.000 MHz, and set the Transmitter Power Level to “HIGH.”
- Set the transceiver to Alignment mode, then rotate the **DIAL** knob to set the Alignment parameter to “TXPW H.”
- Press the **PTT** switch to activate the transmitter, and press the [REV] or [D/MR] key for 65 Watts on the wattmeter, and confirm that supply current remains below 12.5 A.
- Press and hold the [LOW] key for one second to save the new setting, then rotate the **DIAL** knob one click to clockwise to set the Alignment parameter to “TXPW M.”
- Press the **PTT** switch to activate the transmitter, and press the [REV] or [D/MR] key for 25 Watts on the wattmeter, and confirm that supply current remains below 7.5 A.
- Press and hold the [LOW] key for one second to save the new setting, then rotate the **DIAL** knob one click to clockwise to set the Alignment parameter to “TXPWL2.”
- Press the **PTT** switch to activate the transmitter, and press the [REV] or [D/MR] key for 10 Watts on the wattmeter, and confirm that supply current remains below 5 A.
- Press and hold the [LOW] key for one second to save the new setting, then rotate the **DIAL** knob one click to clockwise to set the Alignment parameter to “TXPWL1.”
- Press the **PTT** switch to activate the transmitter, and press the [REV] or [D/MR] key for 5 Watts on the wattmeter, and confirm that supply current remains below 4 A.
- Press and hold the [LOW] key for one second to save

Alignment

the new setting, then press and hold the [MHz] key for one second to exit to the normal operation.

TX Deviation (MODWFM/MODNFM)

1. Tune the transceiver to 146.000 MHz.
2. Inject a 1 kHz audio tone at a level of 60 mV from the Audio Generator.
3. Set the transceiver to Alignment mode, then rotate the **DIAL** knob to set the Alignment parameter to “**MODWFM.**”
4. Press the **PTT** switch to activate the transmitter, and press the [REV] or [D/MR] key so that the deviation meter reading is 4.2 kHz.
5. Press and hold the [LOW] key for one second to save the new setting, then rotate the **DIAL** knob one click to clockwise to set the Alignment parameter to “**MODNFM.**”
6. Press the **PTT** switch to activate the transmitter, and press the [REV] or [D/MR] key so that the deviation meter reading is 2.1 kHz.
7. Press and hold the [LOW] key for one second to save

the new setting, then press and hold the [MHz] key for one second to exit to the normal operation.

CTCSS TX Deviation (TONE W/TONE N)

1. Tune the transceiver to 146.000 MHz.
2. Set the CTCSS tone to 100 Hz.
 - Press and hold the [MHz] key for one second to activate the “Set” (Menu) mode.
 - Rotate the **DIAL** knob to select “**27 SQ TNE.**”
 - Press the [MHz] key momentarily, then rotate the **DIAL** knob to select to 100.0 (Hz).
 - Press and hold the [MHz] key for one second to exit to the normal operation
3. Set the transceiver to Alignment mode, then rotate the **DIAL** knob to set the Alignment parameter to “**TONE W.**”
4. Press the **PTT** switch to activate the transmitter, and press the [REV] or [D/MR] key so that the deviation meter reading is 0.6 kHz.
5. Press and hold the [LOW] key for one second to save the new setting, then rotate the **DIAL** knob one click to counter clockwise to set the Alignment parameter to “**TONE N.**”
6. Press the **PTT** switch to activate the transmitter, and press the [REV] or [D/MR] key so that the deviation meter reading is 0.3 kHz.
7. Press and hold the [LOW] key for one second to save the new setting, then press and hold the [MHz] key for one second to exit to the normal operation.

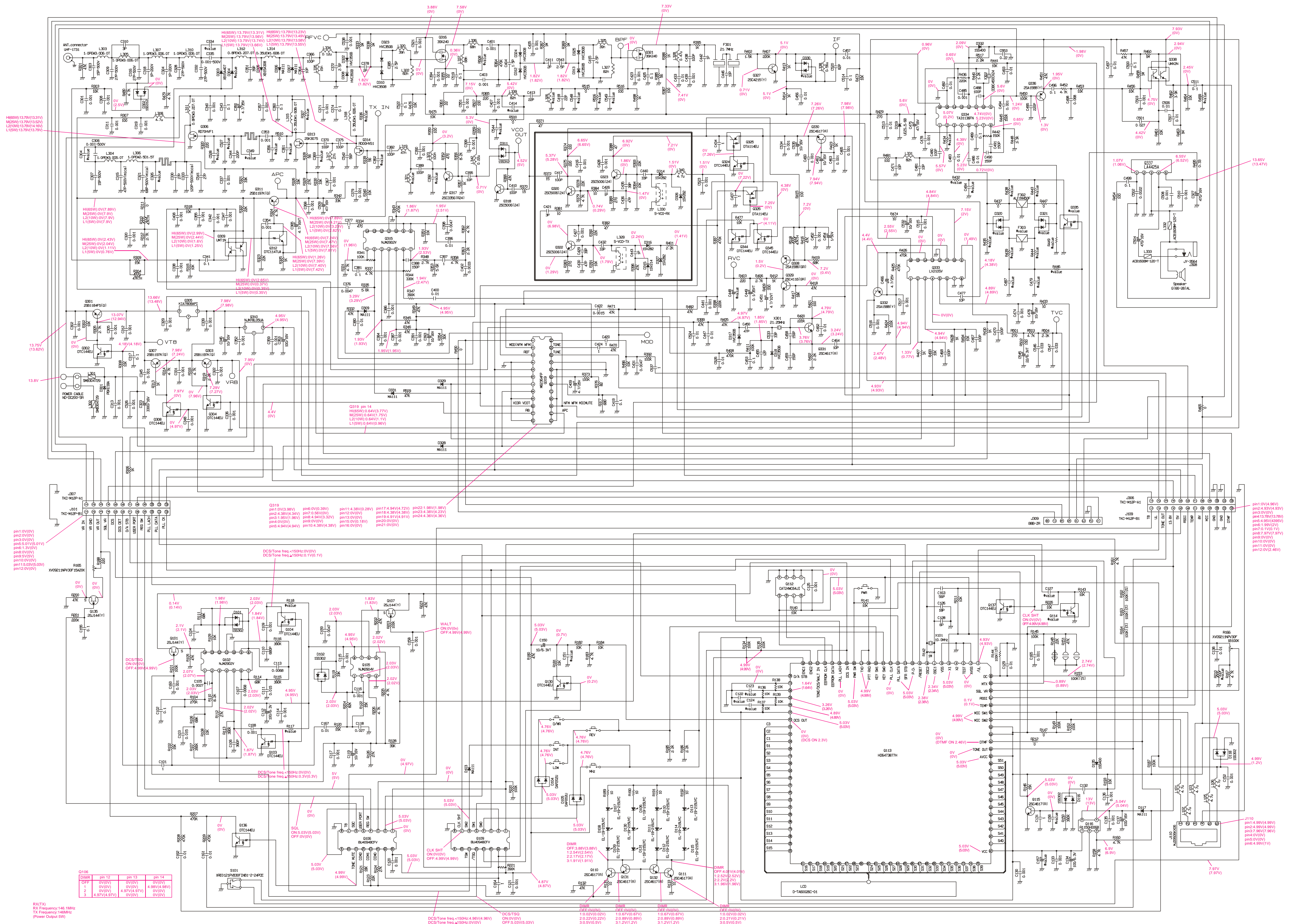

- pin1 0V(0V)
- pin2 0V(0V)
- pin3 0V(0V)
- pin4 0V(0V)
- pin5 0V(0V)
- pin6 0V(0V)
- pin7 0V(0V)
- pin8 0V(0V)
- pin9 0V(0V)
- pin10 0V(0V)
- pin11 0V(0V)
- pin12 0V(0V)

- pin1 0V(0V)
- pin2 0V(0V)
- pin3 0V(0V)
- pin4 0V(0V)
- pin5 0V(0V)
- pin6 0V(0V)
- pin7 0V(0V)
- pin8 0V(0V)
- pin9 0V(0V)
- pin10 0V(0V)
- pin11 0V(0V)
- pin12 0V(0V)

- pin1 0V(0V)
- pin2 0V(0V)
- pin3 0V(0V)
- pin4 0V(0V)
- pin5 0V(0V)
- pin6 0V(0V)
- pin7 0V(0V)
- pin8 0V(0V)
- pin9 0V(0V)
- pin10 0V(0V)
- pin11 0V(0V)
- pin12 0V(0V)

- pin1 0V(0V)
- pin2 0V(0V)
- pin3 0V(0V)
- pin4 0V(0V)
- pin5 0V(0V)
- pin6 0V(0V)
- pin7 0V(0V)
- pin8 0V(0V)
- pin9 0V(0V)
- pin10 0V(0V)
- pin11 0V(0V)
- pin12 0V(0V)

- pin1 0V(0V)
- pin2 0V(0V)
- pin3 0V(0V)
- pin4 0V(0V)
- pin5 0V(0V)
- pin6 0V(0V)
- pin7 0V(0V)
- pin8 0V(0V)
- pin9 0V(0V)
- pin10 0V(0V)
- pin11 0V(0V)
- pin12 0V(0V)

- pin1 0V(0V)
- pin2 0V(0V)
- pin3 0V(0V)
- pin4 0V(0V)
- pin5 0V(0V)
- pin6 0V(0V)
- pin7 0V(0V)
- pin8 0V(0V)
- pin9 0V(0V)
- pin10 0V(0V)
- pin11 0V(0V)
- pin12 0V(0V)

RX(TX) Frequency: 146.1MHz
 TX Frequency: 146MHz
 (Power Output 5W)

μCOM Unit /RF Unit Circuit Diagram

Note

μCOM Unit Parts Layout

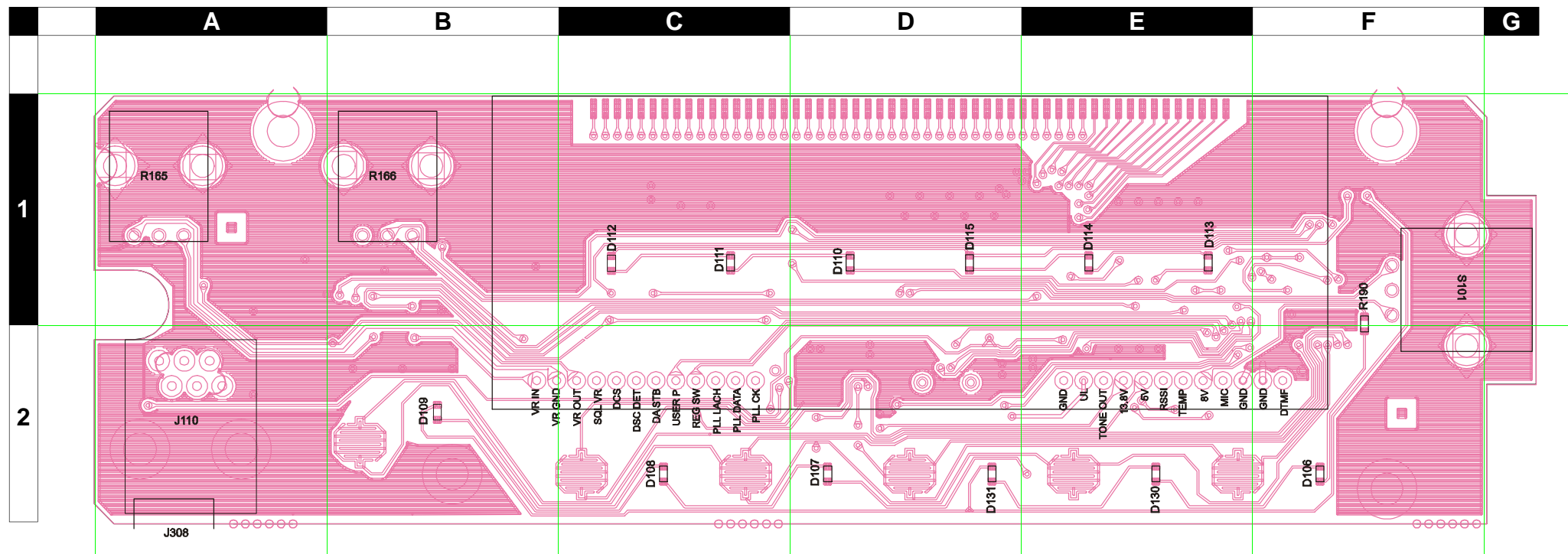

Side A

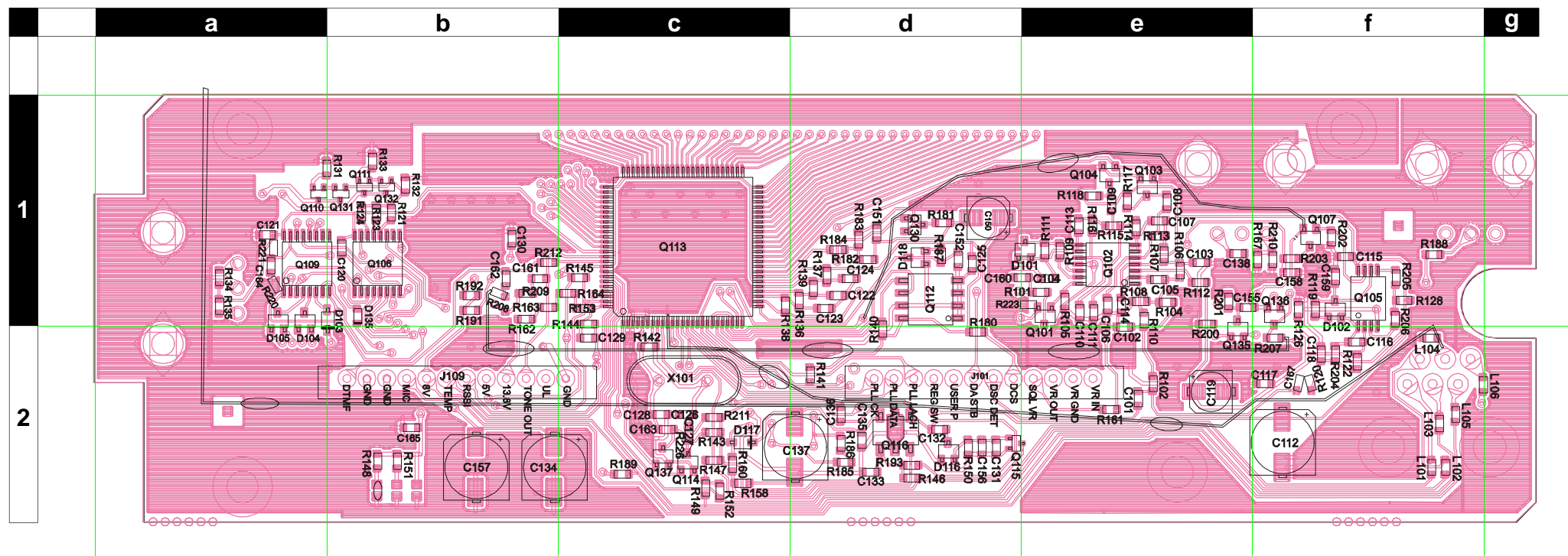

Side B

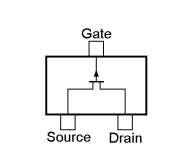

2SJ144Y (VY)
(Q101, 107, 135)

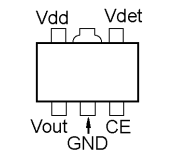

R1150H006B
(Q116)

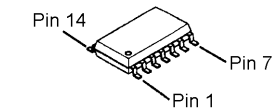

NJM2902V
(Q102)

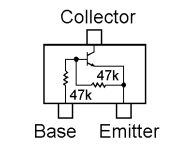

DTC144EU (26)
(Q103, 104, 130, 136, 137)

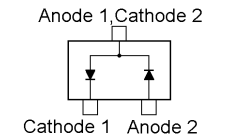

1SS302 (C3)
(D101, 102, 116, 118)

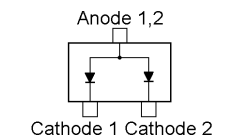

DAP202U (P)
(D104, 105)

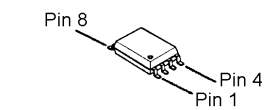

NJM2904V
(Q105)

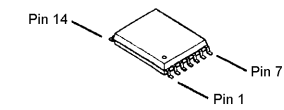

BU4094BCFV
(Q106, 109)

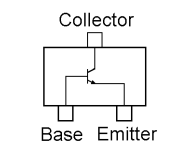

2SC4617R (BR)
(Q110, 111, 115, 130, 132)



CAT24WC64JI
(Q112)

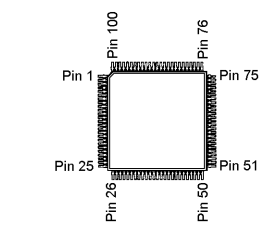

HD6473877H
(Q113)

μCOM Unit Parts List

REF	DESCRIPTION	VALUE	V/W	TOL.	MFR'S DESIG	VXSTD P/N	VERS.	LOT	SIDE	LAY ADR
PCB with Components						S8101442	A2 (USA)			
C101	CHIP CAP.	1uF	10V	B	GRM188B11A105KA61D	S8101390		1-		
C102	CHIP CAP.	0.1uF	16V	B	GRM39B104K16PT	K22124805		1-		
C103	CHIP CAP.	0.015uF	50V	B	GRM188B11H221KD01D	S8101391		1-		
C104	CHIP CAP.	1uF	6.3V	B	GRM39B105K6.3PT	K22084801		1-		
C105	CHIP CAP.	0.0027uF	50V	B	GRM39B272K50PT	K22174829		1-		
C106	CHIP CAP.	390pF	50V	B	GRM39B391K50PT	K22174804		1-		
C107	CHIP CAP.	0.0068uF	50V	B	GRM39B682K50PT	K22174834		1-		
C108	CHIP CAP.	0.001uF	50V	B	GRM39B102K50PT	K22174821		1-		
C109	CHIP CAP.	0.001uF	50V	B	GRM39B102K50PT	K22174821		1-		
C110	CHIP CAP.	680pF	50V	B	GRM39B681K50PT	K22174807		1-		
C111	CHIP CAP.	0.015uF	50V	B	GRM188B11H221KD01D	S8101391		1-		
C112	AL.ELECTRO.CAP.	100uF	6.3V		MV6.3VC100MH63	S8101399		1-		
C113	CHIP CAP.	0.0068uF	50V	B	GRM39B682K50PT	K22174834		1-		
C114	CHIP CAP.	0.001uF	50V	B	GRM39B102K50PT	K22174821		1-		
C115	CHIP CAP.	0.001uF	50V	B	GRM39B102K50PT	K22174821		1-		
C116	CHIP CAP.	0.001uF	50V	B	GRM39B102K50PT	K22174821		1-		
C117	CHIP CAP.	0.001uF	50V	B	GRM39B102K50PT	K22174821		1-		
C118	CHIP CAP.	0.027uF	16V	R	GRM39R273K16PT	K22124802		1-		
C119	AL.ELECTRO.CAP.	10uF	16V		MV16VC10MD55	S8101398		1-		
C120	CHIP CAP.	0.001uF	50V	B	GRM39B102K50PT	K22174821		1-		
C121	CHIP CAP.	0.001uF	50V	B	GRM39B102K50PT	K22174821		1-		
C125	CHIP CAP.	0.001uF	50V	B	GRM39B102K50PT	K22174821		1-		
C126	CHIP CAP.	18pF	50V	CH	GRM39CH180J50PT	K22174217		1-		
C128	CHIP CAP.	6pF	50V	CH	GRM39CH060D50PT	K22174207		1-		
C129	CHIP CAP.	0.01uF	25V	B	GRM39B103K25PT	K22144803		1-		
C130	CHIP CAP.	0.001uF	50V	B	GRM39B102K50PT	K22174821		1-		
C131	CHIP CAP.	1uF	6.3V	B	GRM39B105K6.3PT	K22084801		1-		
C132	CHIP CAP.	1uF	6.3V	B	GRM39B105K6.3PT	K22084801		1-		
C133	CHIP CAP.	0.001uF	50V	B	GRM39B102K50PT	K22174821		1-		
C134	AL.ELECTRO.CAP.	100uF	6.3V		MV6.3VC100MH63	S8101399		1-		
C135	CHIP CAP.	0.001uF	50V	B	GRM39B102K50PT	K22174821		1-		
C136	CHIP CAP.	0.001uF	50V	B	GRM39B102K50PT	K22174821		1-		
C137	AL.ELECTRO.CAP.	100uF	16V		UWX1C101MCR1GB	S8101395		1-		
C138	CHIP CAP.	0.01uF	50V	B	GRM39B103K50PT	K22174823		1-		
C150	CHIP TA.CAP.	10uF	6.3V		TEMSVA0J106M-8R	K78080027		1-		
C152	CHIP CAP.	0.001uF	50V	B	GRM39B102K50PT	K22174821		1-		
C155	CHIP CAP.	0.1uF	16V	B	GRM39B104K16PT	K22124805		1-		
C158	CHIP CAP.	0.001uF	50V	B	GRM39B102K50PT	K22174821		1-		
C159	CHIP CAP.	0.0047uF	50V	B	GRM39B472K50PT	K22174833		1-		
C160	CHIP CAP.	0.001uF	50V	B	GRM39B102K50PT	K22174821		1-		
C161	CHIP CAP.	0.01uF	50V	B	GRM39B103K50PT	K22174823		1-		
C162	CHIP CAP.	0.01uF	50V	B	GRM39B103K50PT	K22174823		1-		
C163	CHIP CAP.	56pF	50V	CH	GRM39CH560J50PT	K22174229		1-		
C164	CHIP CAP.	1uF	10V	B	GRM188B11A105KA61D	S8101390		1-		
C165	CHIP CAP.	0.001uF	50V	B	GRM39B102K50PT	K22174821		1-		
C167	CHIP CAP.	0.01uF	50V	B	GRM39B103K50PT	K22174823		1-		
D101	DIODE				1SS302 TE85R	G2070088		1-	B	e1
D102	DIODE				1SS302 TE85R	G2070088		1-	B	f1
D103	DIODE				MA111-(TX)	G2070338		1-	B	b1
D104	DIODE				DAP202U T106	G2070160		1-	B	a1
D105	DIODE				DAP202U T106	G2070160		1-	B	a1
D106	LED				19-215UYC/S530A2/TR8	S8101421		1-	A	F2
D107	LED				19-215UYC/S530A2/TR8	S8101421		1-	A	D2
D108	LED				19-215UYC/S530A2/TR8	S8101421		1-	A	C2
D109	LED				19-215UYC/S530A2/TR8	S8101421		1-	A	F2
D110	LED				19-215UYC/S530A2/TR8	S8101421		1-	A	D1
D111	LED				19-215UYC/S530A2/TR8	S8101421		1-	A	C1
D112	LED				19-215UYC/S530A2/TR8	S8101421		1-	A	C1
D113	LED				19-215UYC/S530A2/TR8	S8101421		1-	A	E1
D114	LED				19-215UYC/S530A2/TR8	S8101421		1-	A	E1
D115	LED				19-215UYC/S530A2/TR8	S8101421		1-	A	D1
D116	DIODE				1SS302 TE85R	G2070088		1-	B	d2
D117	DIODE				MA111-(TX)	G2070338		1-	B	c2
D118	DIODE				1SS302 TE85R	G2070088		1-	B	d1
D130	LED				19-215UYC/S530A2/TR8	S8101421		1-	A	E2
D131	LED				19-215UYC/S530A2/TR8	S8101421		1-	A	D2
D135	DIODE				1SS400 TE61	G2070634		1-	B	b1
J101	CONNECTOR				TKC-M12P-B1	S8101428		1-		
J109	CONNECTOR				TKC-M12P-B1	S8101428		1-		
J110	CONNECTOR (MIC)				MJD0606KX06	S8101431		1-		
L101	M.RFC	4.7uH			LK1608 4R7K-T	L1690688		1-		
L102	M.RFC	4.7uH			LK1608 4R7K-T	L1690688		1-		
L103	M.RFC	4.7uH			LK1608 4R7K-T	L1690688		1-		
L105	M.RFC	4.7uH			LK1608 4R7K-T	L1690688		1-		
L106	M.RFC	4.7uH			LK1608 4R7K-T	L1690688		1-		

μCOM Unit Parts List

REF	DESCRIPTION	VALUE	V/W	TOL.	MFR'S DESIG	VXSTD P/N	VERS.	LOT	SIDE	LAY ADR
Q101	TRANSISTOR				2SJ144Y TE85R	G3701447Y		1-	B	e1
Q102	IC				NJM2902V-TE1	G1091679		1-	B	e1
Q103	TRANSISTOR				DTC144EU T106	G3070041		1-	B	e1
Q104	TRANSISTOR				DTC144EU T106	G3070041		1-	B	e1
Q105	IC				NJM2904V-TE1	G1091677		1-	B	f1
Q106	IC				BU4094BCFV-E2	G1093527		1-	B	b1
Q107	TRANSISTOR				2SJ144Y TE85R	G3701447Y		1-	B	f1
Q109	IC				BU4094BCFV-E2	G1093527		1-	B	a1
Q110	TRANSISTOR				2SC4617 TL R	G3346178R		1-	B	a1
Q111	TRANSISTOR				2SC4617 TL R	G3346178R		1-	B	b1
Q112	IC				CAT24WC64JI-TE13	S8101423		1-	B	d1
Q113	IC				HD6473877H R0759	S8101437	A2 (USA)	1-	B	c1
Q115	TRANSISTOR				2SC4617 TL R	G3346178R		1-	B	d2
Q116	IC				R1150H006B-T1	S8101422		1-	B	d2
Q130	TRANSISTOR				DTC144EU T106	G3070041		1-	B	d1
Q131	TRANSISTOR				2SC4617 TL R	G3346178R		1-	B	b1
Q132	TRANSISTOR				2SC4617 TL R	G3346178R		1-	B	b1
Q135	TRANSISTOR				2SJ144Y TE85R	G3701447Y		1-	B	e1
Q136	TRANSISTOR				DTC144EU T106	G3070041		1-	B	f1
Q137	TRANSISTOR				DTC144EU T106	G3070041		1-	B	c2
R101	CHIP RES.	100k	1/16W	5%	RMC1/16 104JATP	J24185104		1-		
R102	CHIP RES.	15k	1/16W	5%	RMC1/16 153JATP	J24185153		1-		
R104	CHIP RES.	270k	1/16W	5%	RMC1/16 274JATP	J24185274		1-		
R105	CHIP RES.	47K	1/16W	5%	RMC1/16 473JATP	J24185473		1-		
R106	CHIP RES.	68k	1/16W	5%	RMC1/16 683JATP	J24185683		1-		
R107	CHIP RES.	390k	1/16W	5%	RMC1/16 394JATP	J24185394		1-		
R108	CHIP RES.	10k	1/16W	5%	RMC1/16 103JATP	J24185103		1-		
R109	CHIP RES.	10k	1/16W	5%	RMC1/16 103JATP	J24185103		1-		
R110	CHIP RES.	8.2k	1/16W	5%	RMC1/16 822JATP	J24185822		1-		
R111	CHIP RES.	68k	1/16W	5%	RMC1/16 683JATP	J24185683		1-		
R112	CHIP RES.	27k	1/16W	5%	RMC1/16 273JATP	J24185273		1-		
R113	CHIP RES.	390k	1/16W	5%	RMC1/16 394JATP	J24185394		1-		
R114	CHIP RES.	68k	1/16W	5%	RMC1/16 683JATP	J24185683		1-		
R115	CHIP RES.	390k	1/16W	5%	RMC1/16 394JATP	J24185394		1-		
R116	CHIP RES.	390k	1/16W	5%	RMC1/16 394JATP	J24185394		1-		
R119	CHIP RES.	33k	1/16W	5%	RMC1/16 333JATP	J24185333		1-		
R120	CHIP RES.	15k	1/16W	5%	RMC1/16 153JATP	J24185153		1-		
R121	CHIP RES.	18k	1/16W	5%	RMC1/16 183JATP	J24185183		1-		
R122	CHIP RES.	15k	1/16W	5%	RMC1/16 153JATP	J24185153		1-		
R123	CHIP RES.	22K	1/16W	5%	RMC1/16 223JATP	J24185223		1-		
R124	CHIP RES.	27k	1/16W	5%	RMC1/16 273JATP	J24185273		1-		
R126	CHIP RES.	27k	1/16W	5%	RMC1/16 273JATP	J24185273		1-		
R128	CHIP RES.	39k	1/16W	5%	RMC1/16 393JATP	J24185393		1-		
R131	CHIP RES.	10	1/16W	5%	RMC1/16 100JATP	J24185100		1-		
R132	CHIP RES.	47K	1/16W	5%	RMC1/16 473JATP	J24185473		1-		
R133	CHIP RES.	10	1/16W	5%	RMC1/16 100JATP	J24185100		1-		
R134	CHIP RES.	100k	1/16W	5%	RMC1/16 104JATP	J24185104		1-		
R135	CHIP RES.	100k	1/16W	5%	RMC1/16 104JATP	J24185104		1-		
R136	CHIP RES.	10k	1/16W	5%	RMC1/16 103JATP	J24185103		1-		
R137	CHIP RES.	10k	1/16W	5%	RMC1/16 103JATP	J24185103		1-		
R138	CHIP RES.	10k	1/16W	5%	RMC1/16 103JATP	J24185103		1-		
R139	CHIP RES.	10k	1/16W	5%	RMC1/16 103JATP	J24185103		1-		
R140	CHIP RES.	10k	1/16W	5%	RMC1/16 103JATP	J24185103		1-		
R141	CHIP RES.	10k	1/16W	5%	RMC1/16 103JATP	J24185103		1-		
R142	CHIP RES.	1M	1/16W	5%	RMC1/16 105JATP	J24185105		1-		
R143	CHIP RES.	10k	1/16W	5%	RMC1/16 103JATP	J24185103		1-		
R144	CHIP RES.	100k	1/16W	1%	RMC1/16 104FTP	J24183104		1-		
R145	CHIP RES.	100k	1/16W	5%	RMC1/16 104JATP	J24185104		1-		
R146	CHIP RES.	15k	1/16W	5%	RMC1/16 153JATP	J24185153		1-		
R147	CHIP RES.	0			RMC1/16 000JATP	J24185000		1-		
R148	CHIP RES.	22K	1/16W	5%	RMC1/16 223JATP	J24185223		1-		
R149	CHIP RES.	100k	1/16W	5%	RMC1/16 104JATP	J24185104		1-		
R150	CHIP RES.	390k	1/16W	5%	RMC1/16 394JATP	J24185394		1-		
R151	CHIP RES.	47K	1/16W	5%	RMC1/16 473JATP	J24185473		1-		
R152	CHIP RES.	100k	1/16W	5%	RMC1/16 104JATP	J24185104		1-		
R153	CHIP RES.	100k	1/16W	1%	RMC1/16 104FTP	J24183104		1-		
R158	CHIP RES.	4.7K	1/16W	5%	RMC1/16 472JATP	J24185472		1-		
R160	CHIP RES.	4.7K	1/16W	5%	RMC1/16 472JATP	J24185472		1-		
R161	CHIP RES.	4.7K	1/16W	5%	RMC1/16 472JATP	J24185472		1-		
R162	CHIP RES.	100k	1/16W	1%	RMC1/16 104FTP	J24183104		1-		
R163	CHIP RES.	100k	1/16W	1%	RMC1/16 104FTP	J24183104		1-		
R164	CHIP RES.	100k	1/16W	1%	RMC1/16 104FTP	J24183104		1-		
R165	VR	20k			XV09211NPV30F15A20K	S8101386		1-		
R166	VR	100k			XV09211NPV30F1B100K	S8101387		1-		
R167	CHIP RES.	4.7K	1/16W	5%	RMC1/16 472JATP	J24185472		1-		
R180	CHIP RES.	47K	1/16W	5%	RMC1/16 473JATP	J24185473		1-		

μCOM Unit Parts List

Note

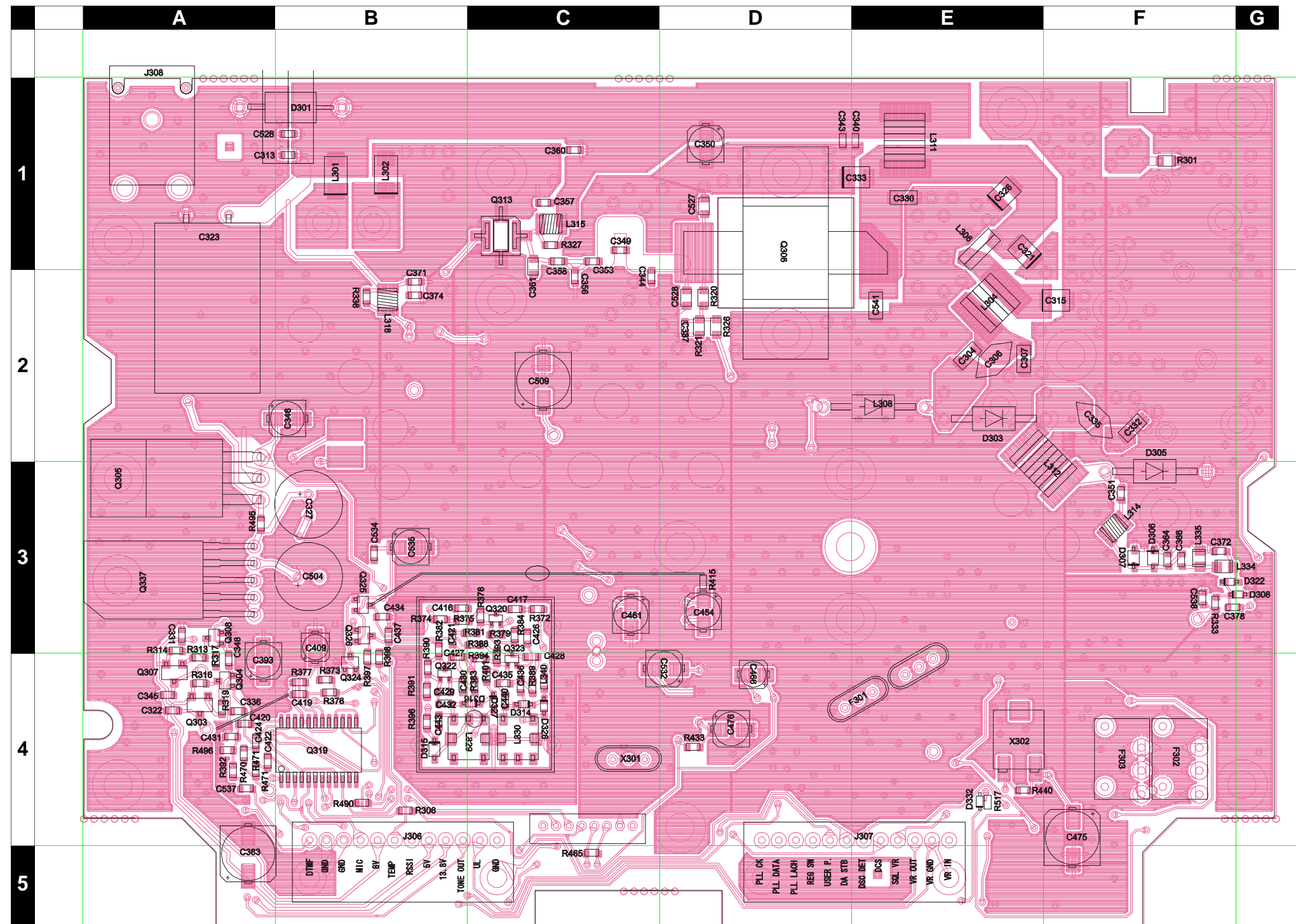
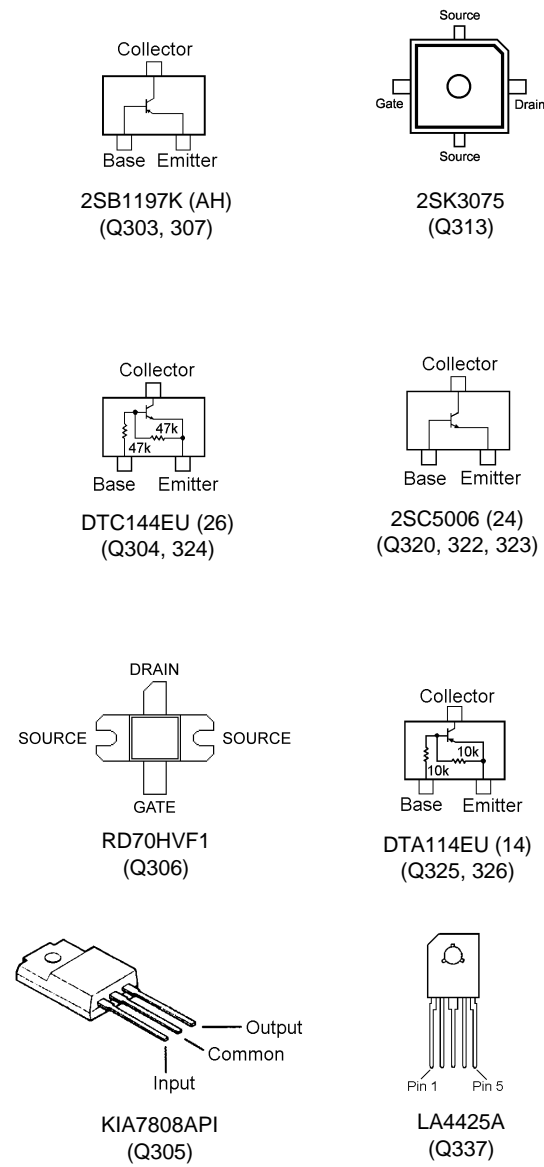

Downloaded by
RadioAmateur.EU

Side A

RF Unit Parts Layout

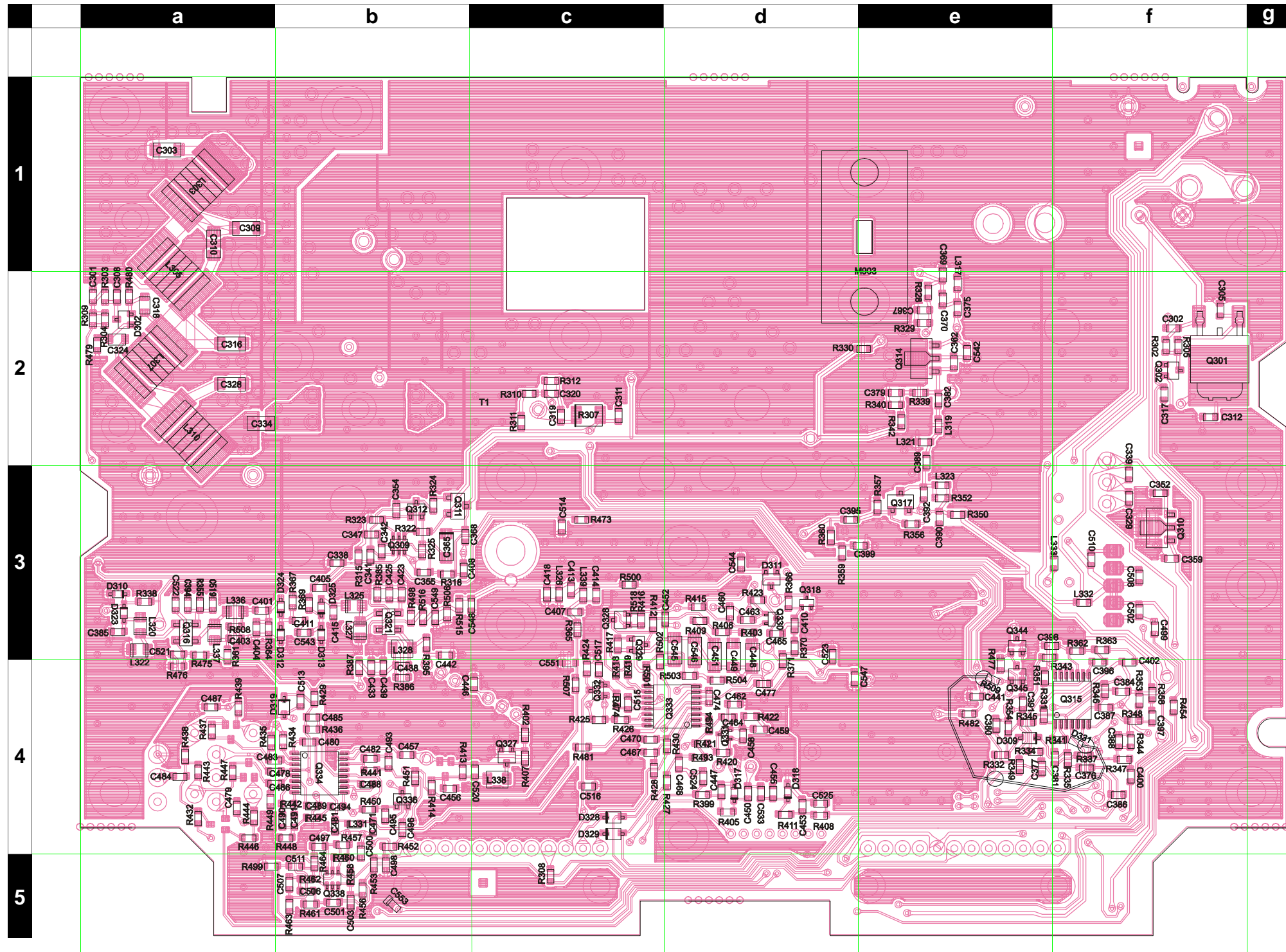

Side B

Downloaded by
RadioAmateur.EU

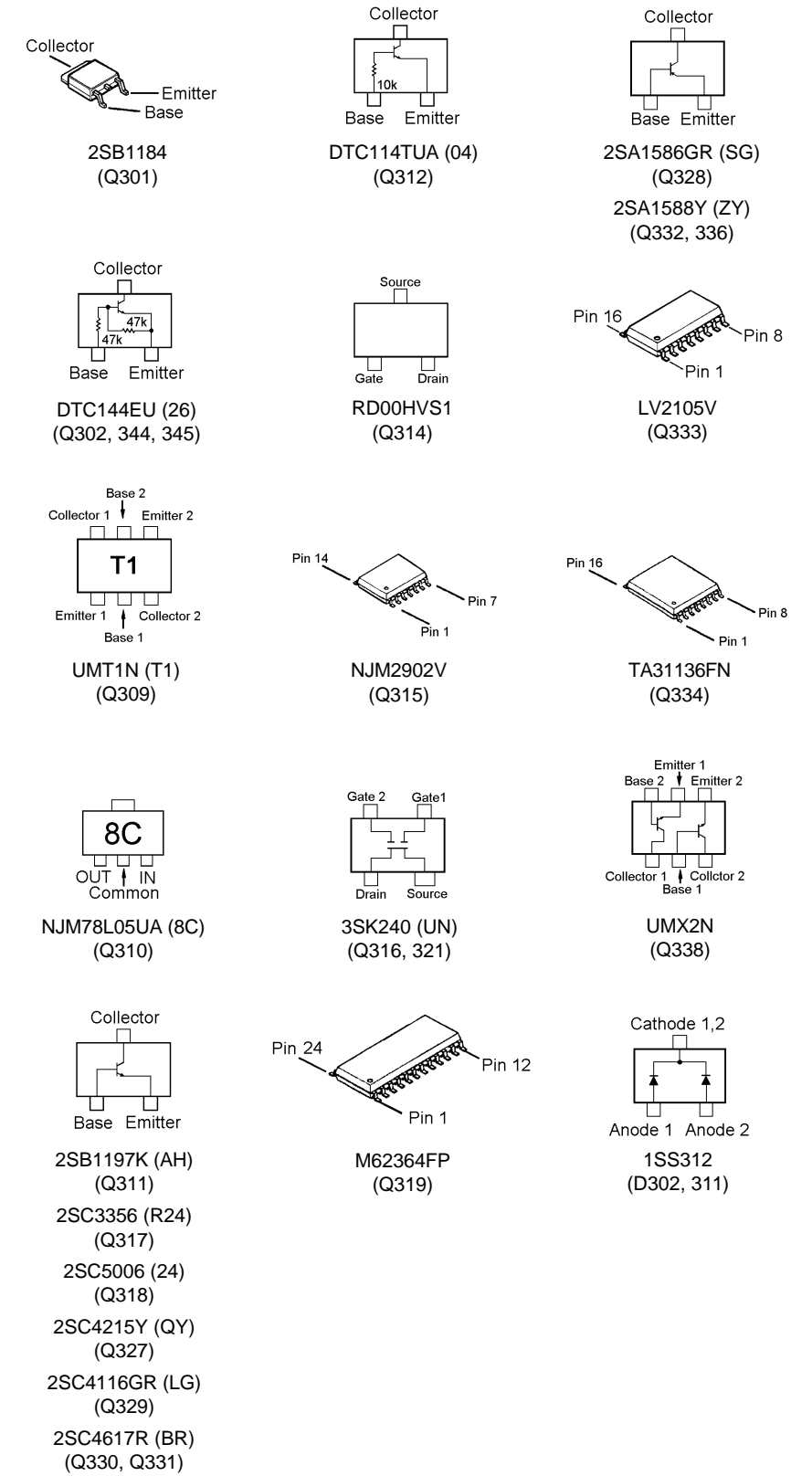

RF Unit Parts List

REF	DESCRIPTION	VALUE	V/W	TOL.	MFR'S DESIG	VXSTD P/N	VERS.	LOT	SIDE	LAY ADR
PCB with Components						S8101438	A2 (USA)			
C301	CHIP CAP.	0.001uF	50V	B	GRM39B102K50PT	K22174821				1-
C302	CHIP CAP.	0.001uF	50V	B	GRM39B102K50PT	K22174821				1-
C303	CHIP CAP.	15pF	500V	CH	GRM42-6CH150J500PT	K22271217				1-
C305	CHIP CAP.	0.001uF	50V	B	GRM39B102K50PT	K22174821				1-
C306	CERAMIC CAP.	0.001uF	500V	B	HM60SJYB102K500	S8101392				1-
C307	CHIP CAP.	15pF	500V	CH	GRM42-6CH150J500PT	K22271217				1-
C308	CHIP CAP.	0.001uF	50V	B	GRM39B102K50PT	K22174821				1-
C309	CHIP CAP.	27pF	500V	CH	GRM42-6CH270J500PT	K22271223				1-
C310	CHIP CAP.	3pF	50V	CJ	GRM40CJ030C50PT	K22170204				1-
C311	CHIP CAP.	0.001uF	50V	B	GRM39B102K50PT	K22174821				1-
C312	CHIP CAP.	0.001uF	50V	B	GRM39B102K50PT	K22174821				1-
C313	CHIP CAP.	0.001uF	50V	B	GRM39B102K50PT	K22174821				1-
C315	FILM CAP.	47pF	500V		UC232H0470J-T	K33279034				1-
C316	CHIP CAP.	27pF	500V	CH	GRM42-6CH270J500PT	K22271223				1-
C317	CHIP CAP.	0.1uF	16V	B	GRM39B104K16PT	K22124805				1-
C318	CHIP CAP.	1pF	200V	CK	GRM40CK010C200PT	K22230208				1-
C319	CHIP CAP.	0.001uF	50V	B	GRM39B102K50PT	K22174821				1-
C320	CHIP CAP.	0.001uF	50V	B	GRM39B102K50PT	K22174821				1-
C321	FILM CAP.	68pF	500V		UC232H0680J-T	K33279030				1-
C322	CHIP CAP.	0.001uF	50V	B	GRM39B102K50PT	K22174821				1-
C323	AL.ELECTRO.CAP.	3300uF	16V		KMG16VB3300M	S8101401				1-
C324	CHIP CAP.	1pF	200V	CK	GRM40CK010C200PT	K22230208				1-
C327	AL.ELECTRO.CAP.	470uF	16V		SMG16VB470M	S8101402				1-
C328	CHIP CAP.	27pF	500V	CH	GRM42-6CH270J500PT	K22271223				1-
C329	CHIP CAP.	0.001uF	50V	B	GRM39B102K50PT	K22174821				1-
C330	CHIP CAP.	27pF	500V	CH	GRM42-6CH270J500PT	K22271223				1-
C331	CHIP CAP.	0.001uF	50V	B	GRM39B102K50PT	K22174821				1-
C332	CHIP CAP.	27pF	500V	CH	GRM42-6CH270J500PT	K22271223				1-
C333	FILM CAP.	120pF	500V		UC232H1200J-T	K33279049				1-
C335	CERAMIC CAP.	0.001uF	500V	B	HM60SJYB102K500	S8101392				1-
C336	CHIP CAP.	0.001uF	50V	B	GRM39B102K50PT	K22174821				1-
C337	CHIP CAP.	0.001uF	50V	B	GRM39B102K50PT	K22174821				1-
C338	CHIP CAP.	0.001uF	50V	B	GRM39B102K50PT	K22174821				1-
C339	CHIP CAP.	0.001uF	50V	B	GRM39B102K50PT	K22174821				1-
C340	CHIP CAP.	0.001uF	50V	B	GRM39B102K50PT	K22174821				1-
C341	CHIP CAP.	0.1uF	16V	B	GRM39B104K16PT	K22124805				1-
C342	CHIP CAP.	0.001uF	50V	B	GRM39B102K50PT	K22174821				1-
C343	CHIP CAP.	0.1uF	16V	B	GRM39B104K16PT	K22124805				1-
C344	CHIP CAP.	220pF	50V	B	GRM39B221K50PT	K22174801				1-
C345	CHIP CAP.	0.001uF	50V	B	GRM39B102K50PT	K22174821				1-
C346	AL.ELECTRO.CAP.	10uF	16V		MV16VC10MD55	S8101398				1-
C347	CHIP CAP.	0.001uF	50V	B	GRM39B102K50PT	K22174821				1-
C348	CHIP CAP.	0.001uF	50V	B	GRM39B102K50PT	K22174821				1-
C350	AL.ELECTRO.CAP.	4.7uF	35V		MVJ35VC4R7MD60	S8101396				1-
C351	CHIP CAP.	39pF	50V	CH	GRM39CH390J50PT	K22174225				1-
C352	CHIP CAP.	0.001uF	50V	B	GRM39B102K50PT	K22174821				1-
C353	CHIP CAP.	0.001uF	50V	B	GRM39B102K50PT	K22174821				1-
C354	CHIP CAP.	0.001uF	50V	B	GRM39B102K50PT	K22174821				1-
C355	CHIP CAP.	0.001uF	50V	B	GRM39B102K50PT	K22174821				1-
C357	CHIP CAP.	0.001uF	50V	B	GRM39B102K50PT	K22174821				1-
C359	CHIP CAP.	0.001uF	50V	B	GRM39B102K50PT	K22174821				1-
C360	CHIP CAP.	0.1uF	16V	B	GRM39B104K16PT	K22124805				1-
C363	AL.ELECTRO.CAP.	100uF	16V		UWX1C101MCR1GB	S8101395				1-
C364	CHIP CAP.	10pF	50V	CH	GRM39CH100D50PT	K22174211				1-
C365	CHIP TA.CAP.	4.7uF	16V		F931C475MAA	S8101394				1-
C366	CHIP CAP.	100pF	50V	CH	GRM39CH101J50PT	K22174235				1-
C367	CHIP CAP.	0.001uF	50V	B	GRM39B102K50PT	K22174821				1-
C368	CHIP CAP.	0.001uF	50V	B	GRM39B102K50PT	K22174821				1-
C370	CHIP CAP.	100pF	50V	CH	GRM39CH101J50PT	K22174235				1-
C371	CHIP CAP.	0.001uF	50V	B	GRM39B102K50PT	K22174821				1-
C372	CHIP CAP.	2.5pF	50V	CJ	GRM39CJ2R5C50PT	K22174259				1-
C374	CHIP CAP.	0.1uF	16V	B	GRM39B104K16PT	K22124805				1-
C375	CHIP CAP.	100pF	50V	CH	GRM39CH101J50PT	K22174235				1-
C376	CHIP CAP.	0.0047uF	50V	B	GRM39B472K50PT	K22174833				1-
C377	CHIP CAP.	1uF	10V	B	GRM188B11A105KA61D	S8101390				1-
C378	CHIP CAP.	2pF	50V	CK	GRM39CK020C50PT	K22174203				1-
C379	CHIP CAP.	0.001uF	50V	B	GRM39B102K50PT	K22174821				1-
C380	CHIP CAP.	0.01uF	25V	B	GRM39B103K25PT	K22144803				1-
C381	CHIP CAP.	0.1uF	16V	B	GRM39B104K16PT	K22124805				1-
C382	CHIP CAP.	100pF	50V	CH	GRM39CH101J50PT	K22174235				1-
C384	CHIP CAP.	0.001uF	50V	B	GRM39B102K50PT	K22174821				1-
C385	CHIP CAP.	2.5pF	50V	CJ	GRM39CJ2R5C50PT	K22174259				1-
C386	CHIP CAP.	0.001uF	50V	B	GRM39B102K50PT	K22174821				1-
C387	CHIP CAP.	0.001uF	50V	B	GRM39B102K50PT	K22174821				1-
C388	CHIP CAP.	150pF	50V	CH	GRM39CH151J50PT	K22174239				1-

RF Unit Parts List

REF	DESCRIPTION	VALUE	V/W	TOL.	MFR'S DESIG	VXSTD P/N	VERS.	LOT	SIDE	LAY ADR
C389	CHIP CAP.	100pF	50V	CH	GRM39CH101J50PT	K22174235		1-		
C390	CHIP CAP.	0.001uF	50V	B	GRM39B102K50PT	K22174821		1-		
C391	CHIP CAP.	0.001uF	50V	B	GRM39B102K50PT	K22174821		1-		
C393	AL.ELECTRO.CAP.	10uF	16V		MV16VC10MD55	S8101398		1-		
C394	CHIP CAP.	0.001uF	50V	B	GRM39B102K50PT	K22174821		1-		
C395	CHIP CAP.	10pF	50V	CH	GRM39CH100D50PT	K22174211		1-		
C396	CHIP CAP.	0.01uF	25V	B	GRM39B103K25PT	K22144803		1-		
C397	CHIP CAP.	1uF	6.3V	B	GRM39B105K6.3PT	K22084801		1-		
C398	CHIP CAP.	0.0047uF	50V	B	GRM39B472K50PT	K22174833		1-		
C399	CHIP CAP.	0.001uF	50V	B	GRM39B102K50PT	K22174821		1-		
C400	CHIP CAP.	0.01uF	25V	B	GRM39B103K25PT	K22144803		1-		
C401	CHIP CAP.	0.001uF	50V	B	GRM39B102K50PT	K22174821		1-		
C402	CHIP CAP.	0.0033uF	50V	B	GRM39B332K50PT	K22174831		1-		
C403	CHIP CAP.	0.001uF	50V	B	GRM39B102K50PT	K22174821		1-		
C404	CHIP CAP.	1.5pF	50V	CK	GRM39CK1R5C50PT	K22174258		1-		
C405	CHIP CAP.	0.001uF	50V	B	GRM39B102K50PT	K22174821		1-		
C407	CHIP CAP.	0.001uF	50V	B	GRM39B102K50PT	K22174821		1-		
C408	CHIP CAP.	0.001uF	50V	B	GRM39B102K50PT	K22174821		1-		
C409	AL.ELECTRO.CAP.	4.7uF	25V		MV25VC4R7MB55	S8101397		1-		
C410	CHIP CAP.	100pF	50V	CH	GRM39CH101J50PT	K22174235		1-		
C411	CHIP CAP.	2pF	50V	CK	GRM39CK020C50PT	K22174203		1-		
C413	CHIP CAP.	22pF	50V	CH	GRM39CH220J50PT	K22174219		1-		
C415	CHIP CAP.	2.5pF	50V	CJ	GRM39CJ2R5C50PT	K22174259		1-		
C416	CHIP CAP.	0.001uF	50V	B	GRM39B102K50PT	K22174821		1-		
C417	CHIP CAP.	100pF	50V	CH	GRM39CH101J50PT	K22174235		1-		
C418	CHIP CAP.	22pF	50V	CH	GRM39CH220J50PT	K22174219		1-		
C419	CHIP CAP.	0.1uF	16V	B	GRM39B104K16PT	K22124805		1-		
C420	CHIP CAP.	1uF	6.3V	B	GRM39B105K6.3PT	K22084801		1-		
C421	CHIP CAP.	3pF	50V	CJ	GRM39CJ030C50PT	K22174204		1-		
C422	CHIP CAP.	0.0015uF	50V	B	GRM39B152K50PT	K22174827		1-		
C423	CHIP CAP.	0.001uF	50V	B	GRM39B102K50PT	K22174821		1-		
C424	CHIP CAP.	1uF	6.3V	B	GRM39B105K6.3PT	K22084801		1-		
C425	CHIP CAP.	0.1uF	16V	B	GRM39B104K16PT	K22124805		1-		
C426	CHIP CAP.	1pF	50V	CK	GRM39CK010C50PT	K22174202		1-		
C427	CHIP CAP.	0.001uF	50V	B	GRM39B102K50PT	K22174821		1-		
C428	CHIP CAP.	0.001uF	50V	B	GRM39B102K50PT	K22174821		1-		
C429	CHIP CAP.	39pF	50V	CH	GRM39CH390J50PT	K22174225		1-		
C430	CHIP CAP.	47pF	50V	CH	GRM39CH470J50PT	K22174227		1-		
C431	CHIP CAP.	0.0047uF	50V	B	GRM39B472K50PT	K22174833		1-		
C432	CHIP CAP.	33pF	50V	CH	GRM39CH330J50PT	K22174223		1-		
C433	CHIP CAP.	0.01uF	25V	B	GRM39B103K25PT	K22144803		1-		
C434	CHIP CAP.	1uF	10V	B	GRM188B11A105KA61D	S8101390		1-		
C435	CHIP CAP.	39pF	50V	CH	GRM39CH390J50PT	K22174225		1-		
C436	CHIP CAP.	47pF	50V	CH	GRM39CH470J50PT	K22174227		1-		
C437	CHIP CAP.	1uF	10V	B	GRM188B11A105KA61D	S8101390		1-		
C438	CHIP CAP.	100pF	50V	CH	GRM39CH101J50PT	K22174235		1-		
C439	CHIP CAP.	0.001uF	50V	B	GRM39B102K50PT	K22174821		1-		
C440	CHIP CAP.	33pF	50V	CH	GRM39CH330J50PT	K22174223		1-		
C441	CHIP CAP.	0.001uF	50V	B	GRM39B102K50PT	K22174821		1-		
C442	CHIP CAP.	1pF	50V	CK	GRM39CK010C50PT	K22174202		1-		
C443	CHIP CAP.	1pF	50V	CK	GRM39CK010C50PT	K22174202		1-		
C446	CHIP CAP.	10pF	50V	CH	GRM39CH100D50PT	K22174211		1-		
C447	CHIP CAP.	0.01uF	25V	B	GRM39B103K25PT	K22144803		1-		
C449	CHIP TA.CAP.	0.1uF	35V		TESVA1V104M1-8R	K78160025		1-		
C450	CHIP CAP.	47pF	50V	CH	GRM39CH470J50PT	K22174227		1-		
C451	CHIP TA.CAP.	4.7uF	10V		TEMSVA1A475M-8R	K78100022		1-		
C452	CHIP CAP.	0.001uF	50V	B	GRM39B102K50PT	K22174821		1-		
C453	CHIP CAP.	0.1uF	16V	B	GRM39B104K16PT	K22124805		1-		
C454	AL.ELECTRO.CAP.	1uF	50V		UWT1H010MCR1GB	K78170005		1-		
C455	CHIP CAP.	12pF	50V	CH	GRM39CH120J50PT	K22174213		1-		
C456	CHIP CAP.	0.01uF	50V	B	GRM39B103K50PT	K22174823		1-		
C457	CHIP CAP.	0.01uF	25V	B	GRM39B103K25PT	K22144803		1-		
C458	CHIP CAP.	150pF	50V	CH	GRM39CH151J50PT	K22174239		1-		
C459	CHIP CAP.	150pF	50V	CH	GRM39CH151J50PT	K22174239		1-		
C460	CHIP CAP.	0.001uF	50V	B	GRM39B102K50PT	K22174821		1-		
C461	AL.ELECTRO.CAP.	10uF	16V		MV16VC10MD55	S8101398		1-		
C462	CHIP CAP.	0.01uF	25V	B	GRM39B103K25PT	K22144803		1-		
C463	CHIP CAP.	0.001uF	50V	B	GRM39B102K50PT	K22174821		1-		
C464	CHIP CAP.	10pF	50V	CH	GRM39CH100D50PT	K22174211		1-		
C465	CHIP CAP.	0.001uF	50V	B	GRM39B102K50PT	K22174821		1-		
C466	AL.ELECTRO.CAP.	4.7uF	25V		MV25VC4R7MB55	S8101397		1-		
C467	CHIP CAP.	100pF	50V	CH	GRM39CH101J50PT	K22174235		1-		
C468	CHIP CAP.	100pF	50V	CH	GRM39CH101J50PT	K22174235		1-		
C470	CHIP CAP.	100pF	50V	CH	GRM39CH101J50PT	K22174235		1-		
C471	CHIP CAP.	10pF	50V	CH	GRM39CH100D50PT	K22174211		1-		
C474	CHIP CAP.	0.001uF	50V	B	GRM39B102K50PT	K22174821		1-		

RF Unit Parts List

REF	DESCRIPTION	VALUE	V/W	TOL.	MFR'S DESIG	VXSTD P/N	VERS.	LOT	SIDE	LAY ADR
C475	AL.ELECTRO.CAP.	47uF	16V		MV16VC47MF55	S8101400		1-		
C476	AL.ELECTRO.CAP.	10uF	16V		MV16VC10MD55	S8101398		1-		
C477	CHIP CAP.	10pF	50V	CH	GRM39CH100D50PT	K22174211		1-		
C478	CHIP CAP.	0.001uF	50V	B	GRM39B102K50PT	K22174821		1-		
C480	CHIP CAP.	100pF	50V	CH	GRM39CH101J50PT	K22174235		1-		
C481	CHIP CAP.	10pF	50V	CH	GRM39CH100D50PT	K22174211		1-		
C482	CHIP CAP.	0.01uF	50V	B	GRM39B103K50PT	K22174823		1-		
C483	CHIP CAP.	0.01uF	50V	B	GRM39B103K50PT	K22174823		1-		
C485	CHIP CAP.	0.001uF	50V	B	GRM39B102K50PT	K22174821		1-		
C486	CHIP CAP.	0.01uF	50V	B	GRM39B103K50PT	K22174823		1-		
C488	CHIP CAP.	100pF	50V	CH	GRM39CH101J50PT	K22174235		1-		
C489	CHIP CAP.	0.1uF	16V	B	GRM39B104K16PT	K22124805		1-		
C490	CHIP CAP.	150pF	50V	CH	GRM39CH151J50PT	K22174239		1-		
C491	CHIP CAP.	150pF	50V	CH	GRM39CH151J50PT	K22174239		1-		
C493	CHIP CAP.	0.01uF	50V	B	GRM39B103K50PT	K22174823		1-		
C494	CHIP CAP.	0.001uF	50V	B	GRM39B102K50PT	K22174821		1-		
C495	CHIP CAP.	220pF	50V	CH	GRM39CH221J50PT	K22174243		1-		
C496	CHIP CAP.	0.1uF	16V	B	GRM39B104K16PT	K22124805		1-		
C497	CHIP CAP.	0.01uF	50V	B	GRM39B103K50PT	K22174823		1-		
C498	CHIP CAP.	0.068uF	16V	B	GRM39B683K16PT	K22124808		1-		
C499	CHIP CAP.	0.1uF	16V	B	GRM39B104K16PT	K22124805		1-		
C500	CHIP CAP.	0.1uF	16V	B	GRM39B104K16PT	K22124805		1-		
C501	CHIP CAP.	0.027uF	16V	R	GRM39R273K16PT	K22124802		1-		
C502	CHIP CAP.	0.0022uF	50V	B	GRM39B222K50PT	K22174822		1-		
C503	CHIP CAP.	0.001uF	50V	B	GRM39B102K50PT	K22174821		1-		
C504	AL.ELECTRO.CAP.	470uF	16V		SMG16VB470M	S8101402		1-		
C506	CHIP CAP.	0.01uF	50V	B	GRM39B103K50PT	K22174823		1-		
C507	CHIP CAP.	0.01uF	50V	B	GRM39B103K50PT	K22174823		1-		
C508	CHIP CAP.	0.001uF	50V	B	GRM39B102K50PT	K22174821		1-		
C509	AL.ELECTRO.CAP.	47uF	16V		MV16VC47MF55	S8101400		1-		
C510	CHIP CAP.	0.001uF	50V	B	GRM39B102K50PT	K22174821		1-		
C511	CHIP CAP.	0.1uF	16V	B	GRM39B104K16PT	K22124805		1-		
C513	CHIP CAP.	0.01uF	25V	B	GRM39B103K25PT	K22144803		1-		
C514	CHIP CAP.	0.1uF	16V	B	GRM39B104K16PT	K22124805		1-		
C515	CHIP CAP.	0.001uF	50V	B	GRM39B102K50PT	K22174821		1-		
C516	CHIP CAP.	0.001uF	50V	B	GRM39B102K50PT	K22174821		1-		
C517	CHIP CAP.	0.001uF	50V	B	GRM39B102K50PT	K22174821		1-		
C519	CHIP CAP.	0.1uF	16V	B	GRM39B104K16PT	K22124805		1-		
C520	CHIP CAP.	82pF	50V	CH	GRM39CH820J50PT	K22174233		1-		
C521	CHIP CAP.	0.001uF	50V	CH	GRM39CH102J50PT	S8101389		1-		
C522	CHIP CAP.	0.1uF	16V	B	GRM39B104K16PT	K22124805		1-		
C523	CHIP CAP.	0.001uF	50V	B	GRM39B102K50PT	K22174821		1-		
C524	CHIP CAP.	0.01uF	25V	B	GRM39B103K25PT	K22144803		1-		
C525	CHIP CAP.	0.01uF	25V	B	GRM39B103K25PT	K22144803		1-		
C526	CHIP CAP.	0.001uF	50V	B	GRM39B102K50PT	K22174821		1-		
C532	AL.ELECTRO.CAP.	10uF	16V		MV16VC10MD55	S8101398		1-		
C533	CHIP CAP.	33pF	50V	CH	GRM39CH330J50PT	K22174223		1-		
C534	CHIP CAP.	0.001uF	50V	B	GRM39B102K50PT	K22174821		1-		
C535	AL.ELECTRO.CAP.	10uF	16V		MV16VC10MD55	S8101398		1-		
C537	CHIP CAP.	1uF	10V	B	GRM188B11A105KA61D	S8101390		1-		
C538	CHIP CAP.	0.001uF	50V	B	GRM39B102K50PT	K22174821		1-		
C541	CHIP CAP.	27pF	500V	CH	GRM42-6CH270J500PT	K22271223		1-		
C542	CHIP CAP.	56pF	50V	CH	GRM39CH560J50PT	K22174229		1-		
C543	CHIP CAP.	2.5pF	50V	CJ	GRM39CJ2R5C50PT	K22174259		1-		
C545	CHIP TA.CAP.	22uF	6.3V		F930J226MAA	S8101393		1-		
C546	CHIP CAP.	0.033uF	50V	B	GRM40B333K50PT	K22170857		1-		
C547	CHIP CAP.	0.033uF	16V	B	GRM39B333K16PT	K22124812		1-		
C551	CHIP CAP.	0.001uF	50V	B	GRM39B102K50PT	K22174821		1-		
C553	CHIP CAP.	0.22uF	10V	B	GRM39B224K10PT	K22104801		1-		
D301	SURGE ABSORBER				P6KE18A	Q9000630		1-	A	B1
D302	DIODE				1SS312-TE85R	S8101420		1-	B	a2
D303	DIODE				XB15A407A2GB	G2090741		1-	A	E2
D305	DIODE				XB15A308A2GB	G2090742		1-	A	F3
D306	DIODE				MA111-(TX)	G2070338		1-	A	F3
D307	DIODE				MA111-(TX)	G2070338		1-	A	F3
D308	DIODE				HVC350B-TRF	G2070596		1-	A	F3
D309	DIODE				MA111-(TX)	G2070338		1-	B	e4
D310	DIODE				HVC350B-TRF	G2070596		1-	B	a3
D311	DIODE				1SS312-TE85R	S8101420		1-	B	d3
D312	DIODE				HVC350B-TRF	G2070596		1-	B	b3
D313	DIODE				HVC350B-TRF	G2070596		1-		
D314	DIODE				1SV282(TPH3)	G2070778		1-	A	C4
D315	DIODE				1SV214 TPH	G2070356		1-	A	B4
D316	DIODE				1SV282(TPH3)	G2070778		1-	A	C4
D317	DIODE				HVC350B-TRF	G2070596		1-	B	d4
D318	DIODE				HVC350B-TRF	G2070596		1-	B	d4

RF Unit Parts List

REF	DESCRIPTION	VALUE	V/W	TOL.	MFR'S DESIG	VXSTD P/N	VERS.	LOT	SIDE	LAY ADR
D319	DIODE				UDZS TE-17 5.6B	G2070910		1-	B	b4
D322	DIODE				HVC350B-TRF	G2070596		1-	A	F3
D323	DIODE				HVC350B-TRF	G2070596		1-	B	a3
D324	DIODE				HVC350B-TRF	G2070596		1-	B	b3
D325	DIODE				HVC350B-TRF	G2070596		1-	B	b3
D326	DIODE				1SV282(TPH3)	G2070778		1-	A	C4
D327	DIODE				1SV282(TPH3)	G2070778		1-	A	C4
D328	DIODE				MA111-(TX)	G2070338		1-	B	c4
D329	DIODE				MA111-(TX)	G2070338		1-	B	c4
D331	DIODE				MA111-(TX)	G2070338		1-	B	f4
D332	DIODE				1SS400 TE61	G2070634		1-	A	E4
F301	XTAL FILTER				UM-5 21.7MHz	S8101426		1-		
F302	CERAMIC FILTER				ALFYM450F=K	H3900531		1-		
J306	CONNECTOR				TKC-M12P-A1	S8101429		1-		
J307	CONNECTOR				TKC-M12P-A1	S8101429		1-		
J308	CONNECTOR (EXT SP)				JY-3564	S8101430		1-		
J309	CONNECTOR				B8B-ZR	P0090650		1-		
L301	FERRITE BEADS				SMB304729	L9190094		1-		
L302	FERRITE BEADS				SMB304729	L9190094		1-		
L303	COIL				1.0PEW3.0D6.0T_E2	S8101405		1-		
L304	COIL				1.0PEW3.0D5.0T_E2	S8101406		1-		
L305	COIL				1.0PEW3.0D6.0T_E2	S8101405		1-		
L306	COIL				1.0PEW2.5D1.5T	S8101408		1-		
L307	COIL				1.0PEW3.0D6.0T_E2	S8101405		1-		
L308	COIL	4.7uH			LAL03KH4R7K	S8101413		1-		
L310	COIL				1.0PEW3.0D6.0T_E2	S8101405		1-		
L311	COIL				0.8PEW3.2D7.0T_E2	S8101407		1-		
L312	COIL				0.8PEW3.2D7.0T_E2	S8101407		1-		
L314	COIL				0.35UEW1.6D8.0T_E2	S8101404		1-		
L315	COIL				0.35UEW1.6D8.0T_E2	S8101404		1-		
L317	M.RFC	0.027uH			HK1608 27NJ-T	L1690521		1-		
L318	COIL				0.35UEW1.6D6.0T_E-2	S8101403		1-		
L319	M.RFC	0.047uH			HK1608 47NJ-T	L1690524		1-		
L320	CHIP COIL	0.039uH			LQN21A39NJ04	L1690616		1-		
L322	CHIP COIL	0.082uH			LQN21A82NJ04	L1690919		1-		
L323	M.RFC	0.1uH			HK1608 R10J-T	L1690528		1-		
L325	CHIP COIL	0.039uH			LQN21A39NJ04	L1690616		1-		
L327	CHIP COIL	0.082uH			LQN21A82NJ04	L1690919		1-		
L328	M.RFC	0.47uH			ELJ-NCR47JF	L1690655		1-		
L329	COIL				S-VCO-TX	S8101410		1-		
L330	COIL				S-VCO-RX	S8101409		1-		
L331	M.RFC	0.082uH			HK1608 82NJ-T	L1690527		1-		
L332	COIL				ACB1608M-120-T	S8101414		1-		
L333	COIL				ACB1608M-120-T	S8101414		1-		
L334	CHIP COIL	0.12uH			LQN21AR12J04	L1690621		1-		
L335	CHIP COIL	0.015uH			LQN21A15NJ04	L1690611		1-		
L336	CHIP COIL	0.068uH			LQN21A68NJ04	L1690605		1-		
L337	CHIP COIL	0.068uH			LQN21A68NJ04	L1690605		1-		
L338	COIL	0.56uH			NL252018T-R56J	S8101411		1-		
L339	M.RFC	0.082uH			HK1608 82NJ-T	L1690527		1-		
L340	M.RFC	4.7uH			LK1608 4R7K-T	L1690688		1-		
L342	COIL	0.22uH			MLF1608DR22KT	S8101412		1-		
Q301	TRANSISTOR				2SB1184F5-Q	S8101415		1-	B	f2
Q302	TRANSISTOR				DTC144EU T106	G3070041		1-	B	f2
Q303	TRANSISTOR				2SB1197K(Q)	S8101416		1-	A	A4
Q304	TRANSISTOR				DTC144EU T106	G3070041		1-	A	A4
Q305	IC				KIA7808API	G1093164		1-	A	A3
Q306	FET				RD70HVF1	G3090140		1-	A	D1
Q307	TRANSISTOR				2SB1197K(Q)	S8101416		1-	A	A4
Q308	TRANSISTOR				DTC144EU T106	G3070041		1-	A	A3
Q309	TRANSISTOR				UMT1N TR	S8101418		1-	B	b3
Q310	IC				NJM78L05UA TE1	G1091325		1-	B	f3
Q311	TRANSISTOR				2SB1197K(Q)	S8101416		1-	B	b3
Q312	TRANSISTOR				DTC114TUA T106	S8101417		1-	b	b3
Q313	FET				2SK3075(TE12L)	G3830758		1-	A	C1
Q314	FET				RD00HVS1	S8101419		1-	B	e2
Q315	IC				NJM2902V-TE1	G1091679		1-	B	f4
Q316	FET				3SK240(TE85L)	G4802407		1-	B	a3
Q317	TRANSISTOR				2SC3356-T2B R24	G3333567D		1-	B	e3
Q318	TRANSISTOR				2SC5006-T1	G3350068		1-	B	d3
Q319	IC				M62364FP 600D	G1093033		1-	A	B4
Q320	TRANSISTOR				2SC5006-T1	G3350068		1-	A	C3
Q321	FET				3SK240(TE85L)	G4802407		1-	B	b3
Q322	TRANSISTOR				2SC5006-T1	G3350068		1-	A	B4
Q323	TRANSISTOR				2SC5006-T1	G3350068		1-	A	C4
Q324	TRANSISTOR				DTC144EU T106	G3070041		1-	A	B4

RF Unit Parts List

REF	DESCRIPTION	VALUE	V/W	TOL.	MFR'S DESIG	VXSTD P/N	VERS.	LOT	SIDE	LAY ADR
Q325	TRANSISTOR				DTA114EU T106	G3070083		1-	A	B3
Q326	TRANSISTOR				DTA114EU T106	G3070083		1-	A	B3
Q327	TRANSISTOR				2SC4215Y TE85R	G3342157Y		1-	B	c4
Q328	TRANSISTOR				2SA1586GR TE85R	G3115867G		1-	B	c3
Q329	TRANSISTOR				2SC4116GR TE85R	G3341167G		1-	B	c3
Q330	TRANSISTOR				2SC4617 TL R	G3346178R		1-	B	d3
Q331	TRANSISTOR				2SC4617 TL R	G3346178R		1-	B	d4
Q332	TRANSISTOR				2SA1588Y(TE85L)	G3115888Y		1-	B	c4
Q333	IC				LV2105V-TLM	G1093191		1-	B	d4
Q334	IC				TA31136FN(EL)	G1091605		1-	B	b4
Q336	TRANSISTOR				2SA1588Y(TE85L)	G3115888Y		1-	B	b4
Q337	IC				LA4425A	G1092241		1-	A	A3
Q338	TRANSISTOR				UMX2N TR	G3070254		1-	B	b5
Q344	TRANSISTOR				DTC144EU T106	G3070041		1-	B	e3
Q345	TRANSISTOR				DTC144EU T106	G3070041		1-	B	e4
R301	CHIP RES.	47k	1/10W	5%	RMC1/10T 473J	J24205473		1-		
R302	CHIP RES.	10k	1/16W	5%	RMC1/16 103JATP	J24185103		1-		
R303	CHIP RES.	10k	1/16W	5%	RMC1/16 103JATP	J24185103		1-		
R304	THERMISTOR				TBPS1R473J475H5Q	S8101388		1-		
R305	CHIP RES.	2.7k	1/16W	5%	RMC1/16 272JATP	J24185272		1-		
R306	CHIP RES.	1k	1/16W	5%	RMC1/16 102JATP	J24185102		1-		
R307	CHIP RES.	100	1/4W	5%	RMC1/4 101JATP	J24245101		1-		
R308	CHIP RES.	10k	1/16W	5%	RMC1/16 103JATP	J24185103		1-		
R309	CHIP RES.	15k	1/16W	5%	RMC1/16 153JATP	J24185153		1-		
R310	THERMISTOR				TBPS1R473J475H5Q	S8101388		1-		
R311	CHIP RES.	0			RMC1/16 000JATP	J24185000		1-		
R312	CHIP RES.	2.7k	1/16W	5%	RMC1/16 272JATP	J24185272		1-		
R313	CHIP RES.	1k	1/16W	5%	RMC1/16 102JATP	J24185102		1-		
R314	CHIP RES.	4.7K	1/16W	5%	RMC1/16 472JATP	J24185472		1-		
R315	CHIP RES.	10k	1/16W	5%	RMC1/16 103JATP	J24185103		1-		
R316	CHIP RES.	4.7K	1/16W	5%	RMC1/16 472JATP	J24185472		1-		
R318	CHIP RES.	10k	1/16W	5%	RMC1/16 103JATP	J24185103		1-		
R319	CHIP RES.	2.2K	1/16W	5%	RMC1/16 222JATP	J24185222		1-		
R320	CHIP RES.	220	1/10W	5%	RMC1/10T 221J	J24205221		1-		
R321	CHIP RES.	33k	1/10W	5%	RMC1/10T 333J	J24205333		1-		
R322	CHIP RES.	22K	1/16W	5%	RMC1/16 223JATP	J24185223		1-		
R323	CHIP RES.	22K	1/16W	5%	RMC1/16 223JATP	J24185223		1-		
R324	CHIP RES.	4.7K	1/16W	5%	RMC1/16 472JATP	J24185472		1-		
R325	CHIP RES.	1k	1/16W	5%	RMC1/16 102JATP	J24185102		1-		
R326	CHIP RES.	33k	1/10W	5%	RMC1/10T 333J	J24205333		1-		
R328	CHIP RES.	56	1/16W	5%	RMC1/16 560JATP	J24185560		1-		
R329	CHIP RES.	27k	1/16W	5%	RMC1/16 273JATP	J24185273		1-		
R330	CHIP RES.	33k	1/16W	5%	RMC1/16 333JATP	J24185333		1-		
R331	CHIP RES.	4.7K	1/16W	5%	RMC1/16 472JATP	J24185472		1-		
R332	CHIP RES.	47K	1/16W	5%	RMC1/16 473JATP	J24185473		1-		
R333	CHIP RES.	1M	1/16W	5%	RMC1/16 105JATP	J24185105		1-		
R334	CHIP RES.	470	1/16W	5%	RMC1/16 471JATP	J24185471		1-		
R335	CHIP RES.	5.6k	1/16W	5%	RMC1/16 562JATP	J24185562		1-		
R337	CHIP RES.	4.7K	1/16W	5%	RMC1/16 472JATP	J24185472		1-		
R338	CHIP RES.	1M	1/16W	5%	RMC1/16 105JATP	J24185105		1-		
R339	CHIP RES.	56	1/16W	5%	RMC1/16 560JATP	J24185560		1-		
R340	CHIP RES.	10k	1/16W	5%	RMC1/16 103JATP	J24185103		1-		
R341	CHIP RES.	100k	1/16W	5%	RMC1/16 104JATP	J24185104		1-		
R342	CHIP RES.	33k	1/16W	5%	RMC1/16 333JATP	J24185333		1-		
R343	CHIP RES.	470K	1/16W	5%	RMC1/16 474JATP	J24185474		1-		
R344	CHIP RES.	330K	1/16W	5%	RMC1/16 334JATP	J24185334		1-		
R345	CHIP RES.	47K	1/16W	5%	RMC1/16 473JATP	J24185473		1-		
R346	CHIP RES.	47K	1/16W	5%	RMC1/16 473JATP	J24185473		1-		
R347	CHIP RES.	390k	1/16W	5%	RMC1/16 394JATP	J24185394		1-		
R348	CHIP RES.	2.7k	1/16W	5%	RMC1/16 272JATP	J24185272		1-		
R349	CHIP RES.	47K	1/16W	5%	RMC1/16 473JATP	J24185473		1-		
R350	CHIP RES.	100	1/16W	5%	RMC1/16 101JATP	J24185101		1-		
R351	CHIP RES.	10k	1/16W	5%	RMC1/16 103JATP	J24185103		1-		
R352	CHIP RES.	470	1/16W	5%	RMC1/16 471JATP	J24185471		1-		
R353	CHIP RES.	5.6k	1/16W	5%	RMC1/16 562JATP	J24185562		1-		
R354	CHIP RES.	30k	1/16W	5%	RMC1/16 303JATP	J24185303		1-		
R355	CHIP RES.	22	1/16W	5%	RMC1/16 220JATP	J24185220		1-		
R356	CHIP RES.	8.2k	1/16W	5%	RMC1/16 822JATP	J24185822		1-		
R357	CHIP RES.	1k	1/16W	5%	RMC1/16 102JATP	J24185102		1-		
R358	CHIP RES.	4.7K	1/16W	5%	RMC1/16 472JATP	J24185472		1-		
R359	CHIP RES.	220	1/16W	5%	RMC1/16 221JATP	J24185221		1-		
R361	CHIP RES.	22	1/16W	5%	RMC1/16 220JATP	J24185220		1-		
R362	CHIP RES.	4.7K	1/16W	5%	RMC1/16 472JATP	J24185472		1-		
R363	CHIP RES.	2.2K	1/16W	5%	RMC1/16 222JATP	J24185222		1-		
R364	CHIP RES.	470K	1/16W	5%	RMC1/16 474JATP	J24185474		1-		
R365	CHIP RES.	220	1/16W	5%	RMC1/16 221JATP	J24185221		1-		

RF Unit Parts List

REF	DESCRIPTION	VALUE	V/W	TOL.	MFR'S DESIG	VXSTD P/N	VERS.	LOT	SIDE	LAY ADR
R366	CHIP RES.	47K	1/16W	5%	RMC1/16 473JATP	J24185473		1-		
R367	CHIP RES.	1M	1/16W	5%	RMC1/16 105JATP	J24185105		1-		
R369	CHIP RES.	1M	1/16W	5%	RMC1/16 105JATP	J24185105		1-		
R370	CHIP RES.	15	1/16W	5%	RMC1/16 150JATP	J24185150		1-		
R371	CHIP RES.	47	1/16W	5%	RMC1/16 470JATP	J24185470		1-		
R372	CHIP RES.	15	1/16W	5%	RMC1/16 150JATP	J24185150		1-		
R373	CHIP RES.	100k	1/16W	5%	RMC1/16 104JATP	J24185104		1-		
R374	CHIP RES.	100	1/16W	5%	RMC1/16 101JATP	J24185101		1-		
R375	CHIP RES.	220	1/16W	5%	RMC1/16 221JATP	J24185221		1-		
R376	CHIP RES.	82	1/16W	5%	RMC1/16 820JATP	J24185820		1-		
R377	CHIP RES.	680	1/16W	5%	RMC1/16 681JATP	J24185681		1-		
R378	CHIP RES.	22K	1/16W	5%	RMC1/16 223JATP	J24185223		1-		
R379	CHIP RES.	4.7K	1/16W	5%	RMC1/16 472JATP	J24185472		1-		
R381	CHIP RES.	10	1/16W	5%	RMC1/16 100JATP	J24185100		1-		
R382	CHIP RES.	47	1/16W	5%	RMC1/16 470JATP	J24185470		1-		
R383	CHIP RES.	270	1/16W	5%	RMC1/16 271JATP	J24185271		1-		
R384	CHIP RES.	10	1/16W	5%	RMC1/16 100JATP	J24185100		1-		
R385	CHIP RES.	56	1/16W	5%	RMC1/16 560JATP	J24185560		1-		
R386	CHIP RES.	1k	1/16W	5%	RMC1/16 102JATP	J24185102		1-		
R387	CHIP RES.	100	1/16W	5%	RMC1/16 101JATP	J24185101		1-		
R388	CHIP RES.	47	1/16W	5%	RMC1/16 470JATP	J24185470		1-		
R389	CHIP RES.	270	1/16W	5%	RMC1/16 271JATP	J24185271		1-		
R390	CHIP RES.	22K	1/16W	5%	RMC1/16 223JATP	J24185223		1-		
R391	CHIP RES.	10k	1/16W	5%	RMC1/16 103JATP	J24185103		1-		
R392	CHIP RES.	100k	1/16W	5%	RMC1/16 104JATP	J24185104		1-		
R393	CHIP RES.	22K	1/16W	5%	RMC1/16 223JATP	J24185223		1-		
R394	CHIP RES.	10k	1/16W	5%	RMC1/16 103JATP	J24185103		1-		
R395	CHIP RES.	1k	1/16W	5%	RMC1/16 102JATP	J24185102		1-		
R396	CHIP RES.	47K	1/16W	5%	RMC1/16 473JATP	J24185473		1-		
R397	CHIP RES.	470K	1/16W	5%	RMC1/16 474JATP	J24185474		1-		
R398	CHIP RES.	220K	1/16W	5%	RMC1/16 224JATP	J24185224		1-		
R399	CHIP RES.	47K	1/16W	5%	RMC1/16 473JATP	J24185473		1-		
R401	CHIP RES.	2.2K	1/16W	5%	RMC1/16 222JATP	J24185222		1-		
R402	CHIP RES.	1.5k	1/16W	5%	RMC1/16 152JATP	J24185152		1-		
R403	CHIP RES.	220	1/16W	5%	RMC1/16 221JATP	J24185221		1-		
R405	CHIP RES.	47K	1/16W	5%	RMC1/16 473JATP	J24185473		1-		
R406	CHIP RES.	2.7k	1/16W	5%	RMC1/16 272JATP	J24185272		1-		
R407	CHIP RES.	220K	1/16W	5%	RMC1/16 224JATP	J24185224		1-		
R408	CHIP RES.	470K	1/16W	5%	RMC1/16 474JATP	J24185474		1-		
R409	CHIP RES.	330	1/16W	5%	RMC1/16 331JATP	J24185331		1-		
R411	CHIP RES.	100k	1/16W	5%	RMC1/16 104JATP	J24185104		1-		
R412	CHIP RES.	1k	1/16W	5%	RMC1/16 102JATP	J24185102		1-		
R413	CHIP RES.	1k	1/16W	5%	RMC1/16 102JATP	J24185102		1-		
R414	CHIP RES.	1k	1/16W	5%	RMC1/16 102JATP	J24185102		1-		
R415	CHIP RES.	100	1/16W	5%	RMC1/16 101JATP	J24185101		1-		
R416	CHIP RES.	47K	1/16W	5%	RMC1/16 473JATP	J24185473		1-		
R417	CHIP RES.	18k	1/16W	5%	RMC1/16 183JATP	J24185183		1-		
R418	CHIP RES.	47K	1/16W	5%	RMC1/16 473JATP	J24185473		1-		
R419	CHIP RES.	68k	1/16W	5%	RMC1/16 683JATP	J24185683		1-		
R420	CHIP RES.	220K	1/16W	5%	RMC1/16 224JATP	J24185224		1-		
R421	CHIP RES.	100	1/16W	5%	RMC1/16 101JATP	J24185101		1-		
R422	CHIP RES.	2.2K	1/16W	5%	RMC1/16 222JATP	J24185222		1-		
R423	CHIP RES.	1k	1/16W	5%	RMC1/16 102JATP	J24185102		1-		
R424	CHIP RES.	100k	1/16W	5%	RMC1/16 104JATP	J24185104		1-		
R425	CHIP RES.	470K	1/16W	5%	RMC1/16 474JATP	J24185474		1-		
R426	CHIP RES.	470K	1/16W	5%	RMC1/16 474JATP	J24185474		1-		
R427	CHIP RES.	1k	1/16W	5%	RMC1/16 102JATP	J24185102		1-		
R428	CHIP RES.	1k	1/16W	5%	RMC1/16 102JATP	J24185102		1-		
R429	CHIP RES.	270	1/16W	5%	RMC1/16 271JATP	J24185271		1-		
R430	CHIP RES.	1k	1/16W	5%	RMC1/16 102JATP	J24185102		1-		
R433	CHIP RES.	10	1/16W	5%	RMC1/16 100JATP	J24185100		1-		
R436	CHIP RES.	220K	1/16W	5%	RMC1/16 224JATP	J24185224		1-		
R437	CHIP RES.	0			RMC1/16 000JATP	J24185000		1-		
R440	CHIP RES.	1.2k	1/16W	5%	RMC1/16 122JATP	J24185122		1-		
R441	CHIP RES.	10k	1/16W	5%	RMC1/16 103JATP	J24185103		1-		
R442	CHIP RES.	150k	1/16W	5%	RMC1/16 154JATP	J24185154		1-		
R445	CHIP RES.	150k	1/16W	5%	RMC1/16 154JATP	J24185154		1-		
R447	CHIP RES.	0			RMC1/16 000JATP	J24185000		1-		
R448	CHIP RES.	3.3K	1/16W	5%	RMC1/16 332JATP	J24185332		1-		
R450	CHIP RES.	100k	1/16W	5%	RMC1/16 104JATP	J24185104		1-		
R451	CHIP RES.	47K	1/16W	5%	RMC1/16 473JATP	J24185473		1-		
R452	CHIP RES.	4.7K	1/16W	5%	RMC1/16 472JATP	J24185472		1-		
R453	CHIP RES.	10k	1/16W	5%	RMC1/16 103JATP	J24185103		1-		
R454	CHIP RES.	100	1/16W	5%	RMC1/16 101JATP	J24185101		1-		
R456	CHIP RES.	10k	1/16W	5%	RMC1/16 103JATP	J24185103		1-		
R457	CHIP RES.	47K	1/16W	5%	RMC1/16 473JATP	J24185473		1-		

RF Unit Parts List

REF	DESCRIPTION	VALUE	V/W	TOL.	MFR'S DESIG	VXSTD P/N	VERS.	LOT	SIDE	LAY ADR
R458	CHIP RES.	1M	1/16W	5%	RMC1/16 105JATP	J24185105		1-		
R460	CHIP RES.	1M	1/16W	5%	RMC1/16 105JATP	J24185105		1-		
R461	CHIP RES.	10k	1/16W	5%	RMC1/16 103JATP	J24185103		1-		
R462	CHIP RES.	3.9k	1/16W	5%	RMC1/16 392JATP	J24185392		1-		
R463	CHIP RES.	1M	1/16W	5%	RMC1/16 105JATP	J24185105		1-		
R464	CHIP RES.	10k	1/16W	5%	RMC1/16 103JATP	J24185103		1-		
R465	CHIP RES.	0			RMC1/16 000JATP	J24185000		1-		
R470	CHIP RES.	47K	1/16W	5%	RMC1/16 473JATP	J24185473		1-		
R471	CHIP RES.	47K	1/16W	5%	RMC1/16 473JATP	J24185473		1-		
R473	CHIP RES.	10k	1/16W	5%	RMC1/16 103JATP	J24185103		1-		
R474	CHIP RES.	10	1/16W	5%	RMC1/16 100JATP	J24185100		1-		
R475	CHIP RES.	10k	1/16W	5%	RMC1/16 103JATP	J24185103		1-		
R476	CHIP RES.	10k	1/16W	5%	RMC1/16 103JATP	J24185103		1-		
R477	CHIP RES.	10k	1/16W	5%	RMC1/16 103JATP	J24185103		1-		
R479	CHIP RES.	4.7K	1/16W	5%	RMC1/16 472JATP	J24185472		1-		
R480	CHIP RES.	4.7K	1/16W	5%	RMC1/16 472JATP	J24185472		1-		
R481	CHIP RES.	100	1/16W	5%	RMC1/16 101JATP	J24185101		1-		
R482	CHIP RES.	47K	1/16W	5%	RMC1/16 473JATP	J24185473		1-		
R490	CHIP RES.	0			RMC1/16 000JATP	J24185000		1-		
R493	CHIP RES.	10k	1/16W	5%	RMC1/16 103JATP	J24185103		1-		
R494	CHIP RES.	10k	1/16W	5%	RMC1/16 103JATP	J24185103		1-		
R495	CHIP RES.	0.33	1/10W	1%	SR731JTDR330F	S8101385		1-		
R496	CHIP RES.	10k	1/16W	5%	RMC1/16 103JATP	J24185103		1-		
R498	CHIP RES.	1k	1/16W	5%	RMC1/16 102JATP	J24185102		1-		
R500	CHIP RES.	0			RMC1/16 000JATP	J24185000		1-		
R501	CHIP RES.	270	1/16W	5%	RMC1/16 271JATP	J24185271		1-		
R502	CHIP RES.	150	1/16W	5%	RMC1/16 151JATP	J24185151		1-		
R503	CHIP RES.	4.7K	1/16W	5%	RMC1/16 472JATP	J24185472		1-		
R504	CHIP RES.	2.2K	1/16W	5%	RMC1/16 222JATP	J24185222		1-		
R507	CHIP RES.	100	1/16W	5%	RMC1/16 101JATP	J24185101		1-		
R509	CHIP RES.	47K	1/16W	5%	RMC1/16 473JATP	J24185473		1-		
R510	CHIP RES.	0			RMC1/16 000JATP	J24185000		1-		
R515	CHIP RES.	0			RMC1/16 000JATP	J24185000		1-		
R516	CHIP RES.	100	1/16W	5%	RMC1/16 101JATP	J24185101		1-		
R517	CHIP RES.	2.2M	1/16W	5%	RMC1/16 225JATP	J24185225		1-		
R518	THERMISTOR				TBPS1R473J475H5Q	S8101388		1-		
X301	XTAL				UM-5.2S 21.25MHz	S8101424		1-		
X302	CERAMIC DISC.				CDBC450CX24-TC	H7901340		1-		
	CASE-SHIELD					S8002054		1-		
	SPRING-EARTH					S8002069		1-		
	SPACER					S8002064		1-		
	CABLE (with BLADE FUSE)					S8101435		1-		

RF Unit Parts List

Note



Copyright 2003
VERTEX STANDARD CO., LTD.
All rights reserved

No portion of this manual
may be reproduced without
the permission of
VERTEX STANDARD CO., LTD.

Printed in Japan.