

# FT-2500M

## Mil-Spec 2-m FM Transceiver

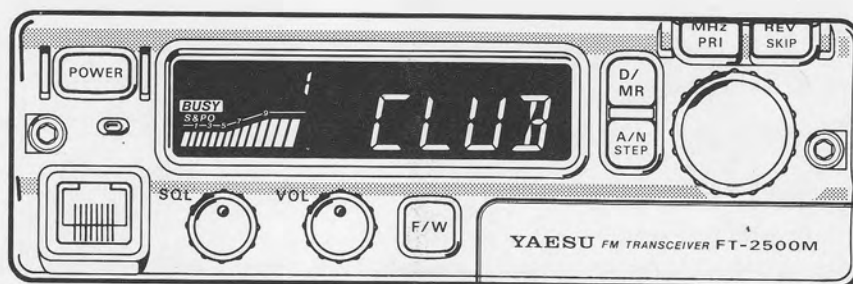

## Technical Supplement

YAESU MUSEN CO., LTD.

C.P.O. Box 1500, Tokyo, Japan

YAESU U.S.A.

17210 Edwards Rd., Cerritos, California 90703

U.S.A.

YAESU EUROPE B.V.

Snipweg 3. 1118DN Schiphol, The Netherlands

YAESU UK LTD.

Unit 2, Maple Grove Business Centre

Lawrence Rd., Hounslow, Middlesex TW4 6DR, UK

# Contents

## I. General Information

Introduction . . . . .	1-1
Specifications . . . . .	1-2
Chip Component Information . . . . .	1-3
Circuit Description . . . . .	1-7
Block Diagram . . . . .	1-11
Interconnection Diagram . . . . .	1-13
Exploded View & Miscellaneous Parts . . . . .	1-15

## II. Servicing

Case Disassembly & PCB Access . . . . .	2-1
LCD & Control Unit Access . . . . .	2-1
Lithium Backup Battery Replacement . . . . .	2-1
Panel Lamp Replacement . . . . .	2-1
9600 Baud Packet Modification . . . . .	2-2
Channel Display-Only Mode . . . . .	2-4

Alignment . . . . .	2-5
PLL & Transmitter . . . . .	2-6
PLL VCV ( <i>Varactor Control Voltage</i> ) . . . . .	2-6
PLL Reference Frequency . . . . .	2-7
Transmitter Output . . . . .	2-7
Transmitter Deviation . . . . .	2-7
Receiver . . . . .	2-8
Interstage Transformers . . . . .	2-8
S-Meter Calibration . . . . .	2-8
Scanner Center Stop . . . . .	2-8
Squelch . . . . .	2-8

## III. Board Units (Schematics, Layout & Parts List)

VCO Unit . . . . .	3A-1
MAIN Unit . . . . .	3B-1
MIC Unit . . . . .	3C
CNTL Unit . . . . .	3D-1
DISPLAY Unit . . . . .	3E-1

## IV. Optional Board Units (Schematics, Layout & Parts)

FRC-6 DTMF Paging Unit . . . . .	4A-1
FTS-17A CTCSS Tone Squelch Unit . . . . .	4B-1
MH-26G8j Microphone . . . . .	4C
MH-27A8j Microphone . . . . .	4D-1

Cut out the label at the right and place it behind the clear plastic window in the spine of the manual binder.

**FT-2500M**  
Technical Supplement



The FT-2500M is Yaesu's new successor to the famous FT-2400H, the industry's first amateur transceiver designed to meet rugged U.S. military specifications for shock and vibration (MIL-SPEC 810-C). The FT-2500M is upgraded with a new front panel and control knob layout, and additional operator features.

Selectable power output of 5, 25 or 50 watts without the need of forced air cooling is possible due to the large heatsink surface area of the compartmentalized one-piece diecast chassis. Backlighting for the large LCD (display) and knobs is manually adjustable, or automatically controlled by a photosensor, and the less-used buttons have a flip-down protective cover. The thirty-one tunable memories can each be programmed with a 4-character channel name, which can then be displayed in place of frequency, as desired.

Each memory offers complete programmability and scanning functions, such as independent tx/rx frequencies, independent repeater offset and CTCSS tone, programmable scan limits, selectable scan resume modes and memory skip, priority monitoring and a 1-touch instant-recall

CALL channel. Channel steps are user-selectable from 5 to 50 kHz, and Automatic Repeater Shift can set standard repeater shifts when you tune to a repeater subband. A 1750-Hz tone generator is included in European versions. A 39-tone programmable CTCSS encoder is built in as standard, and the FTS-17A CTCSS unit can be installed to provide tone squelched private channels and a CTCSS paging bell feature to sound a paging alert tone when the tone squelch opens.

DTMF (Dual-Tone, Multi-Frequency) -based selective calling and private paging capabilities can be easily added with the optional FRC-6, controlled entirely from the front panel. You can select any of 999 3-digit ID codes for your transceiver, and then have your receiver stay quiet until your code is received (from any standard DTMF-equipped transceiver). When a call is received, the FT-2500M displays the caller's code, and a paging beeper can be set to sound and even to respond to the call automatically. Seven DTMF code memories store your ID plus those of six other frequently-called stations or groups you wish to monitor.

# Specifications

---

## General

Frequency Range:	144~146 or 148 MHz Tx, or 144~146 MHz or 140~174 MHz Rx
Channel Steps:	5, 10, 12.5, 15, 20, 25 & 50 kHz
Frequency Stability:	< ±10 ppm (-20° to +60° C)
Mode of Emission:	G3E (F3)
Antenna Impedance:	50 ohms, unbalanced
Supply voltage:	13.8 VDC ±10%, negative ground
Current Consumption (typical):	Rx: 600 mA, Tx hi/mid/low: 12/9/5A
Operating Temp. Range:	-20° to +60° C
Case Size (WHD):	160 x 50 x 180 mm (w/o knobs)
Weight:	1.5 kg (3.3 lb.)

## Transmitter

Output Power (high/mid/low):	50/25/5W
Modulation Type:	Variable Reactance
Maximum Deviation:	±5 kHz
Spurious Radiation:	less than -60 dB
Microphone Impedance:	2kΩ

## Receiver

Circuit Type:	Double Conversion Superheterodyne
IFs:	21.4 MHz & 455 kHz
Sensitivity (for 12dB SINAD):	better than 0.2 μV
Selectivity (-6/-60 dB):	12/30 kHz
IF Rejection:	better than 70 dB
Image Rejection:	better than 70 dB
Maximum AF Output:	3.5 W into 4 ohms @10% THD

*Specifications are subject to change without notice or obligation.*

# Chip Component Information

The diagrams below indicate some of the distinguishing features of common chip components.

## Capacitors

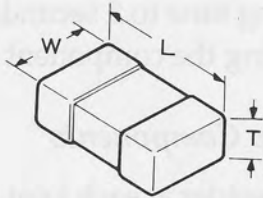

(Unit : mm)

Type	L	W	T
3216	3.2	1.6	0.45~0.60
2125	2.0	1.25	0.35~0.50
1608	1.6	0.8	0.65~0.95

## Tantalum Capacitors

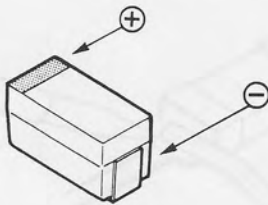

## Resistors

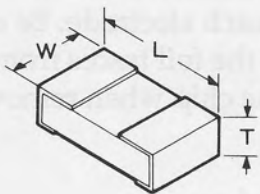

Type	L	W	T
1/10	2.0	1.25	0.45
1/16	1.6	0.8	0.45

### INDICATED LETTERS

**1 2 3 4**  
**5 6 7 8**  
**9 0 .**

Type RMC 1/10W, 1/16W

Marking\* 100,222,473.....

473		
Ten unit	One unit	Multiplier code
0	0	$10^0$
1	1	$10^1$
2	2	$10^2$
3	3	$10^3$
4	4	$10^4$
5	5	$10^5$
6	6	$10^6$
7	7	$10^7$
8	8	$10^8$
9	9	$10^9$

Examples :

100 = 10Ω

222 = 2.2kΩ

473 = 47kΩ

# Chip Component Information

## Replacing Chip Components

Chip components are installed at the factory by a series of robots. The first one places a spot of adhesive resin at the location where each part is to be installed, and later robots handle and place parts using vacuum suction.

For single-sided boards, solder paste is applied and the board is then baked to harden the resin and flow the solder. For double-sided boards, no solder paste is applied, but the board is baked (or exposed to ultra-violet light) to cure the resin before dip soldering.

In our laboratories and service shops, small quantities of chip components are mounted manually by applying a spot of resin, placing them with tweezers, and then soldering by very small dual streams of hot air (without physical contact during soldering). We remove parts by first removing solder using a vacuum suction iron, which applies a light, steady vacuum at the iron tip, and then breaking the adhesive with tweezers.

The special vacuum soldering/desoldering equipment is recommended if you expect to do a lot of chip replacements. Otherwise, it is usually possible to remove and replace chip components with only a tapered, temperature-controlled soldering iron, a set of tweezers and braided copper solder wick. Soldering iron temperature should be less than 280 °C (536 °F).

## Precautions for Chip Replacement

- ✗ Do not disconnect a chip forcefully, or the foil pattern may peel off the board.
- ✗ Never re-use a chip component. Dispose of all removed chip components immediately to avoid mixing with new parts.
- ✗ Limit soldering time to 3 seconds or less to avoid damaging the component and board.

## Removing Chip Components

- Remove the solder at each joint, one joint at a time, using solder wick whetted with non-acidic flux as shown below. Avoid applying pressure, and do not attempt to remove the tinning from the chip's electrode.

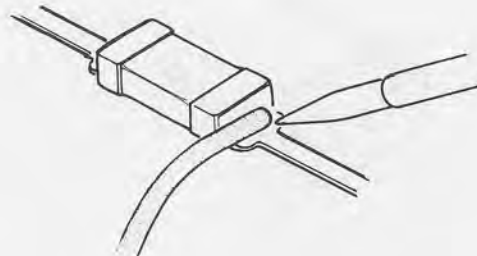

- Grasp the chip on both sides with tweezers, and gently twist the tweezers back and forth (to break the adhesive bond) while alternately heating each electrode. Be careful to avoid peeling the foil traces from the board. Dispose of the chip when removed.

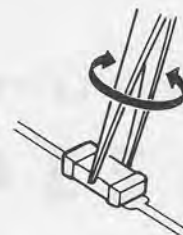

- After removing the chip, use the copper braid and soldering iron to which away any excess solder and smooth the land for installation of the replacement part.

## *Install a Replacement Chip*

As the value of some chip components is not indicated on the body of the chip, be careful to get the right part for replacement.

- Apply a small amount of solder to the land on one side where the chip is to be installed. Avoid too much solder, which may cause bridging (shorting to other parts).



- Hold the chip with tweezers in the desired position, and apply the soldering iron with a motion line that is indicated by the arrow in the diagram below. Do not apply heat for more than 3 seconds.

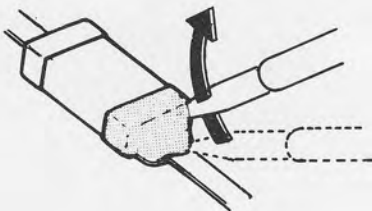

- Remove the tweezers and solder the electrode on the other side in the manner just described.

Install a Replacement Chip  
As the value of some chip components is not indicated on the body of the chip, be careful to get the right part for replacement.

- Apply a small amount of solder to the land on one side where the chip is to be installed. Avoid too much solder, which may cause bridging (shorting to other parts).



- Hold the chip with tweezers in the desired position, and apply the soldering iron with a motion line that indicates by the arrow in the diagram below. Do not apply heat for more than 3 seconds.



- Remove the tweezers and solder the electrode on the other side in the manner just described.



## Receive Signal Path

Incoming RF from the antenna jack is delivered to the Main Unit and passed through a low-pass filter and a  $\frac{1}{4}$ -wave antenna switching network consisting of coils L1003 & L1004, capacitors C1003 & C1004, and diodes D1001 & D1025. Signals within the frequency range of the transceiver are then passed through a varactor-tuned bandpass filter consisting of T1001/T1002 before RF amplification by Q1001 (3SK131). The amplified RF is then bandpass filtered again by varactor-tuned resonators T1003/T1004, to ensure pure in-band input to 1st mixer Q1002/Q1003 (2SK302GR  $\times$  2).

Buffered output from the VCO Unit is amplified by Q1005 (2SC2759) and lowpass filtered by L1009 and C1042/C1043, to provide a pure 1st local signal between 118.6 and 152.6 MHz to the 1st mixer. The 21.4-MHz 1st mixer product is passed through dual monolithic crystal filter XF1001 & XF1002 ( $\pm$  7.5 kHz BW) to strip away all but the desired signal, which is then amplified by Q1004 (2SC2714Y).

The amplified 1st IF signal is applied to FM IF subsystem IC Q1008 (MC3372ML), which contains the 2nd mixer, 2nd local oscillator, limiter amplifier, noise amplifier, S-meter amplifier and squelch gates. A 2nd local signal is generated from 21.855 MHz crystal X1001, which produces the 455 kHz 2nd IF when mixed with the 1st IF signal within Q1008. The 2nd IF is passed through ceramic filter CF1001 to strip away unwanted mixer products, and then applied to the limiter amp in Q1008, which removes amplitude variations in the 455 kHz IF before detection of the speech by ceramic discriminator CD1001.

Detected audio is delivered from Q1008 to the CNTL Unit, where it passes through buffer amplifier Q2018 (2SC2712GR) and audio gate Q2002 (DTC114EK) before de-emphasis, and high-pass filtering by Q2001-2 (NJM2902M- $\frac{1}{4}$ ). Another audio muting gate, Q2003 (DTC114EK), passes the signal, which is then combined with beeper audio originating from the microprocessor through Beeper volume trimmer VR2001. The level of the combined receiver and beeper audio on the CNTL Unit is set by VOL potentiometer VR3002 on the DISP Unit and is then returned the Main Unit for amplification by Q1023

(TDA2003H) up to 2 watts for the optional headphone jack or 8-ohm loudspeaker.

## Squelch Control

The squelch circuit consists of noise amplifier Q1007 (2SC2712GR) and a highpass filter and squelch trigger within Q1008 on the MAIN Unit, and control circuitry within microprocessor Q2006 (SC418082CFU) on the CNTL Unit.

When no carrier is received, noise at the output of the detector stage in Q1008 is amplified by Q1007 and highpass filtered by the noise amp section of Q1008, and then rectified by D1012 to provide a DC control voltage for the squelch switching section within Q1008. With no carrier, pin 14 of Q1008 is high. This signal is inverted by Q1006 (IMH5) and delivered to BUSY pin 16 of main microprocessor Q2006 on the CNTL Unit as the Scan Stop signal, which causes the **BUSY** indication on the display when the squelch is open. This signal also causes the microprocessor to cut receiver audio in two places on the CNTL Unit mentioned already: opening audio mute gate Q2002, and pulling the audio line to ground just before the audio amplifier at Q2003, thus silencing the receiver while no signal is being received, and during transmission.

When a carrier appears at the discriminator, noise is removed from the output, causing pin 14 of Q1008 to go low. This signals the microprocessor to activate the **BUSY** indicator through LCD driver Q3001 (LC7582E). The microprocessor then checks for CTCSS tone detection from the FTS-17A Tone Squelch Unit (if installed), and for Digital Code Squelch information (if the FRC-6 Pager Unit is installed). If not transmitting and tone squelch is not activated, or if the received tone matches that programmed, the microprocessor switches Q2002 and Q2003 to allow audio to pass to the amplifier and loudspeaker.

## Center-Stop Scanning

To ensure that scanning stops at the center of a detected signal, discriminator output from pin 9 of Q1008 is also delivered to comparator circuit Q2001 (NJM2902- $\frac{3}{4}$  &  $\frac{4}{4}$ ) on the CNTL Unit, which compares the discriminator output to a preset DC level. The output of the comparator connects to the Scan Stop line, preventing the received signal from signalling the microprocessor to stop scanning until the signal has been

# Circuit Description

tuned to its peak level, preset by Center-Stop trimmer VR2007.

## Transmit Signal Path

Speech input from the microphone is delivered via the Mic (Jack) Unit and DISPLAY Unit to the CNTL Unit, where it passed through Mic Mute switch D2003 (DAP202K) for amplification and pre-emphasis by Q2007-1 (NJM2902M- $\frac{1}{4}$ ). To prevent over-deviation, the audio is processed by IDC (instantaneous deviation control) stage Q2007- $\frac{2}{4}$ , and then lowpass filtered by Q2007- $\frac{3}{4}$  & - $\frac{4}{4}$ (NJM2902M) before delivery to the modulator on the VCO Unit.

If a CTCSS tone is enabled for transmission, the subaudible tone from microprocessor Q2006 on the CNTL Unit is lowpass filtered by Q2001-1 and mixed with the IDC-processed speech audio. Also, DTMF tones generated by the FRC-6 option (if installed) or directly from the microprocessor, are applied to the transmit audio chain at the input of the IDC stage. The microprocessor also disables microphone at Mic Mute switch D2003.

The modulating audio is delivered to diode D305 (1SV214) on the VCO Unit, frequency modulating the PLL carrier up to  $\pm 5$  kHz from the unmodulated carrier at the transmitting frequency. The modulated signal from transmitter VCO Q303 (2SC3356) is buffered by Q305 (2SC2759) and delivered to the Main Unit for amplification by Q1012 (2SC2759), Q1011 (MMBR951L) and Q1010 (2SC2053). The low level transmit signal is then finally amplified by PA module Q1009 (M67781L) up to 50 watts. Harmonic spurious radiation in the final output is suppressed by a 3-pole lowpass filter on the Main Unit, and the transmit signal then passes through  $\frac{1}{4}$ -wave antenna switch D1016 (UM9415) before delivery to the antenna.

## Automatic Transmit Power Control

RF power output from the final amplifier is sampled by C1064 and rectified by D1017 (1SS97). The resulting DC is passed by high/medium/low power controller Q1017 (FMS1) and transmit inhibit gate Q1018 (IMX1) to Automatic Power Controller Q1019 (2SB1143S) which regulates supply voltage to transmitter RF amplifiers Q1009 and Q1010, so as to maintain stable high, medium or low output power under varying antenna loading conditions.

## Spurious Suppression

Generation of spurious products by the transmitter is minimized by the fundamental carrier frequency being equal to the final transmitting frequency, modulated directly in the transmit VCO. Additional harmonic suppression is provided by a 3-pole lowpass filter consisting of L1002, L1013, L1014 and C1002, C1061, C1063, C1065-C1067, and C1164, resulting in more than 60 dB harmonic suppression (for transmitting frequencies in the amateur band) prior to delivery to the antenna.

## PLL Frequency Synthesizer

PLL circuitry on the Main Unit consists of prescaler Q1025 (MC12022SLAD) and PLL subsystem IC Q1024 (MC145158F2), which contains a reference oscillator/divider, serial-to-parallel data latch, programmable divider and a phase comparator. Stability is obtained by a regulated 5-V supply to Q1024 and temperature compensating capacitors associated with 12.8-MHz frequency reference crystal X1002.

Receiver VCO Q301 (2SC3356) on the VCO Unit oscillates between 118.6 and 152.6 according to the programmed receiving frequency. The VCO output is buffered by Q305 (2SC2759) on the VCO Unit, and then returned to the MAIN Unit where a sample of the output is buffered by Q1028 (2SC2714Y) for application to prescaler/swallow counter Q1025. There the VCO signal is divided by 64 or 65, according to a control signal from the data latch section of Q1024, before being applied to the programmable divider section of the PLL chip.

The data latch section of Q1024 also receives serial dividing data from microprocessor Q2006 on the CNTL Unit, which causes the predivided VCO signal to be further divided by 23,720 — 30,520 in the programmable divider section, depending upon the desired receive frequency, so as to produce a 5-kHz or 6.25-kHz derivative of the current VCO frequency. Meanwhile, the reference divider section of Q1024 divides the 12.8-MHz crystal reference by 2560 (or 2048) to produce the 5-kHz (or 6.25-kHz) loop reference (respectively).

The 5-kHz (or 6.25-kHz) signal from the programmable divider (derived from the VCO) and that derived from the crystal are applied to the

phase detector section of Q1024, which produces a dual 5-V pulsed output with pulse duration depending on the phase difference between the input signals. This pulse train is converted to DC by charge pump Q1026/Q1027 (IMX5/IMZ2), lowpass filtered, and then fed back to varactors D301 and D302 (1T363 × 2) on the VCO Unit.

Changes in the level of the DC voltage applied to D301/D302 affect the reactance in the tank circuit of VCO Q301, changing the oscillating frequency according to the phase difference between the signals derived from the VCO and the crystal reference oscillator. The VCO is thus phase-locked to the crystal reference oscillator.

The output of receiver VCO Q301, after buffering by Q305, is delivered to the Main Unit for amplification by Q1005 before application to the 1st mixer, as described previously.

Transmitter VCO Q303 (2SC3356) oscillates between 140 and 174 MHz according to the programmed transmit frequency. The remainder of the PLL circuitry is shared with the receiver. However, the dividing data from the microprocessor is such that the VCO frequency is at the actual transmit frequency (rather than offset for IFs, as in the receiving case). Also, the transmitter VCO is modulated by the filtered speech audio applied to modulating varactor D305, as described previously.

### *Transmit Inhibit*

When the transmit PLL is unlocked pin 7 of PLL chip Q1024 goes to a logic low, turning on Q1020 (DTA143EK) and turning off half of Q1018. This unlock signal produces a low impedance at the base of the other half of Q1018, which then turns off Automatic Power Controller Q1019 to disable the supply voltage to transmitter RF am-

plifiers Q1009 and Q1010, disabling the transmitter.

### *Miscellaneous Circuits*

#### *Power-On Sequencing & Panel Lamps*

Pressing the **POWER** switch on the DISP Unit turns on Q2017 (DTC114EK) on the CNTL Unit, applying 5 volts from regulator Q2012 (L7805) via 9-volt regulator Q1013 (AN6541) and the 13.8-V supply line to the base of Q2016 (2SB1140S). This pulls RESET pin 75 of microprocessor Q2006 low, causing PO pin 66 to go high. The PO line then pulls the base of Q2017 (DTC114EK) low, lighting the pilot lamps via Q2005 (2SC2712GR) and Q2004 (2SB1143S). Lamp brightness is controlled by CdS photosensor CS3001, which provides an input to microprocessor Q2006, pin 49. An pulsed DC output is then applied to the integrator circuit formed by C2015 and R2021, which produces a DC bias proportional to the pulse train input, which is then applied to the base of Q2005 (2SC2712GR), and Q2004 (2SB1143S), controlling voltage to the panel and display lamps.

#### *Push-To-Talk Transmit Activation*

The PTT switch on the microphone is connected to pin 44 of microprocessor Q2006, so that when the switch is closed pin 69 (tx/rx) goes low. This signal is delivered to power bus controller Q1021 (IMH5) on the MAIN Unit, which then disables the receiver by disabling the 9-V supply bus at Q1022 (DTA143EK) to the front end, IF, discriminator and receiver VCO circuitry. At the same time, Q1015 (2SB1143S) activates the transmit 9-V supply line to enable the transmitter.

plifiers Q1009 and Q1010, disabling the transmitter

Miscellaneous Circuits

Power-On Sequencing & Panel Lamps

Pressing the POWER switch on the DSP Unit turns on Q2017 (DTC114EK) on the CNTL Unit applying 5 volts from regulator Q2012 (L7805) via 9-volt regulator Q1013 (AN68241) and the 1.35-V supply line to the base of Q2016 (2SB1140S). This pulls RESET pin 75 of microprocessor Q2006 low, causing PO pin 66 to go high. The PO line then pulls the base of Q2017 (DTC114EK) low, lighting the pilot lamps via Q2005 (2SC2712GR) and Q2004 (2SB1143S). Lamp brightness is controlled by Cds photoresistor C23001, which provides an input to microprocessor Q2006, pin 48. An pulsed DC output is then applied to the integrator circuit formed by C2015 and R2021, which produces a DC bias proportional to the pulse train input, which is then applied to the base of Q2005 (2SC2712GR) and Q2004 (2SB1143S), controlling voltage to the panel and display lamps.

Push-To-Talk Transmitt Activation

The PTT switch on the microphone is connected to pin 44 of microprocessor Q2006, so that when the switch is closed pin 69 (TX) goes low. This signal is delivered to power bus controller Q1021 (1MH5) on the MAIN Unit, which then disables the receiver by disabling the 9-V supply bus at Q1022 (DTA143EK) to the front end. At the same time, Q1015 (2SB1143S) activates the transmitter 9-V supply line to enable the transmitter.

phase detector section of Q1024, which produces a dual 5-V pulsed output with pulse duration depending on the phase difference between the input signals. This pulse train is converted to DC by charge pump Q1025/Q1027 (1MX2/AM2), lowpass filtered, and then fed back to varactors D301 and D302 (1T883 x 2) on the VCO Unit.

Changes in the level of the DC voltage applied to D301/D302 affect the reactance in the tank circuit of VCO Q301, changing the oscillating frequency according to the phase difference between the signals derived from the VCO and the crystal reference oscillator. The VCO is thus phase-locked to the crystal reference oscillator.

The output of receiver VCO Q301, after buffering by Q305, is delivered to the Main Unit for amplification by Q1005 before application to the 1st mixer, as described previously.

Transmitter VCO Q303 (2SC3356) oscillates between 140 and 174 MHz according to the programmed transmit frequency. The remainder of the PLL circuitry is shared with the receiver. However, the dividing data from the microprocessor is such that the VCO frequency is at the actual transmit frequency (rather than offset for it, as in the receiving case). Also, the transmitted VCO is modulated by the filtered speech audio applied to modulating varactor D305, as described previously.

Transmit Inhibit

When the transmit PLL is unlocked pin 7 of PLL chip Q1024 goes to a logic low, turning on Q1020 (DTA143EK) and turning off half of Q1018. This unlock signal produces a low impedance at the base of the other half of Q1018, which then turns off Automatic Power Controller Q1019 to disable the supply voltage to transmitter RF amplifier.

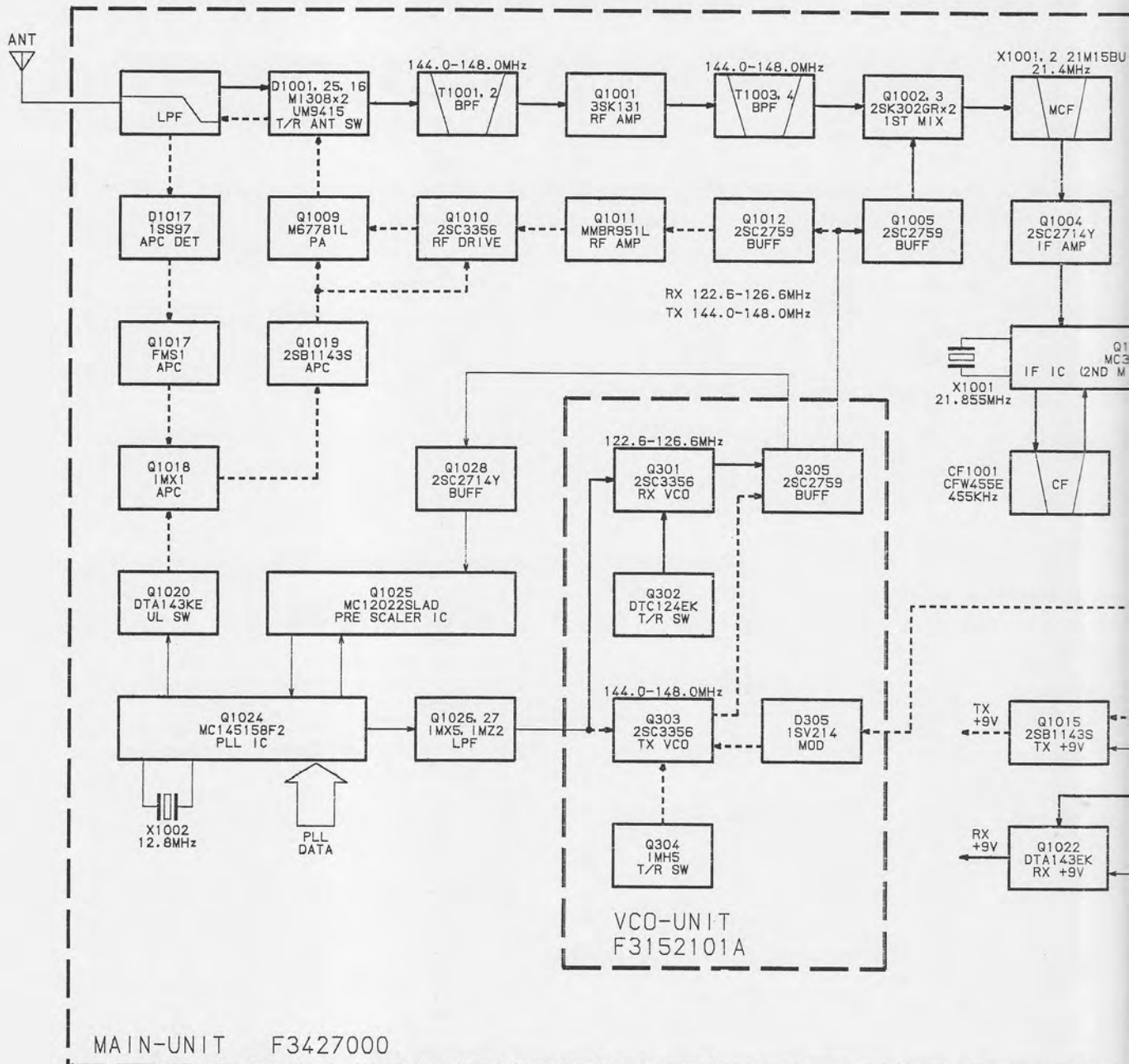

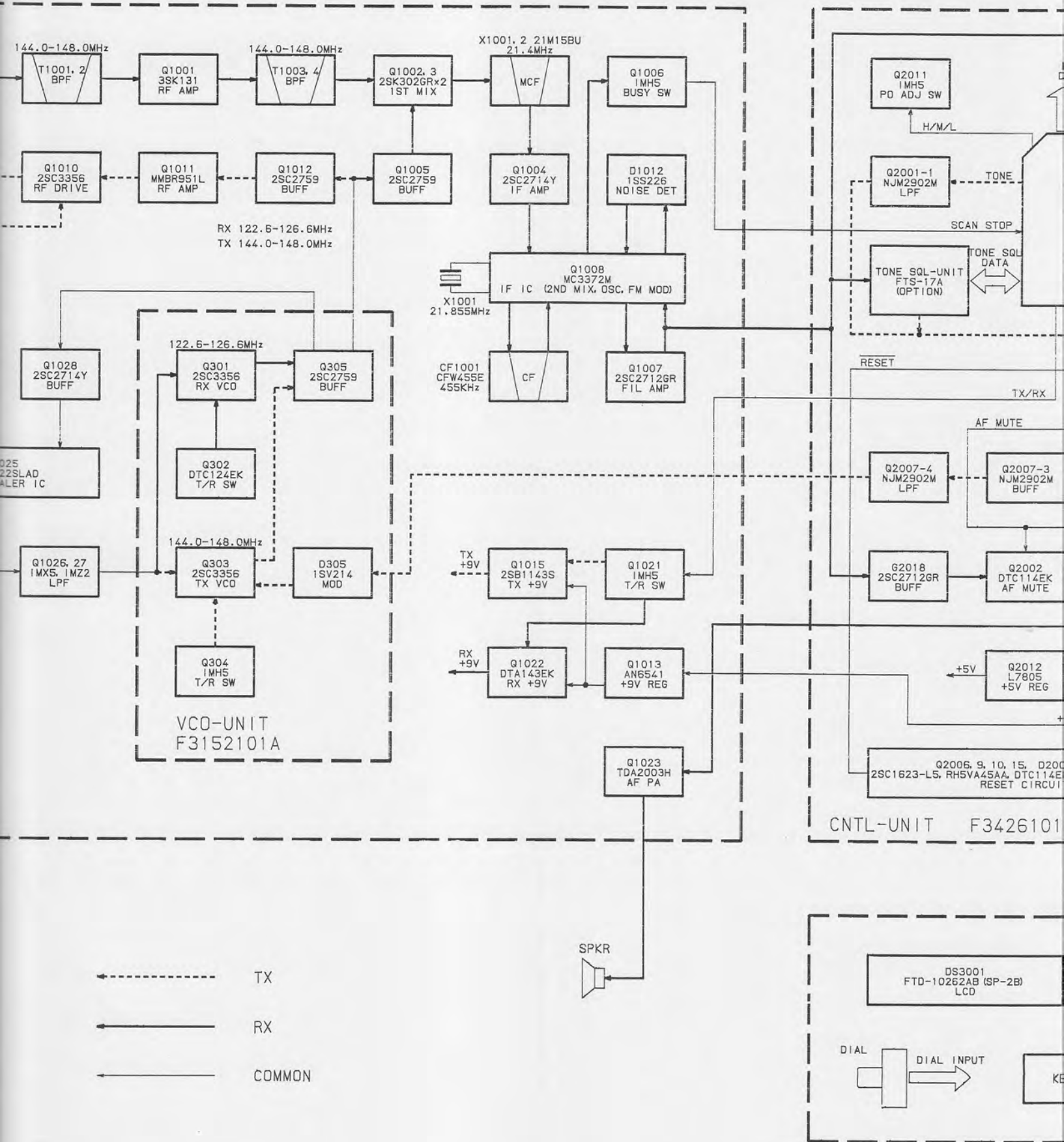

144.0-148.0MHz

144.0-148.0MHz

X1001.2 21M15BU  
21.4MHz

T1001.2  
BPF

Q1001  
3SK131  
RF AMP

T1003.4  
BPF

Q1002.3  
2SK302GRx2  
1ST MIX

MCF

Q1006  
1MHS  
BUSY SW

Q1010  
2SC3356  
RF DRIVE

Q1011  
MMBR951L  
RF AMP

Q1012  
2SC2759  
BUFF

Q1005  
2SC2759  
BUFF

Q1004  
2SC2714Y  
IF AMP

D1012  
1SS226  
NOISE DET

RX 122.6-126.6MHz  
TX 144.0-148.0MHz

Q1008  
MC3372M  
IF IC (2ND MIX, OSC, FM MOD)

X1001  
21.855MHz

CF1001  
CFW455E  
455KHz

CF

Q1007  
2SC2712GR  
FIL AMP

Q1028  
2SC2714Y  
BUFF

122.6-126.6MHz

Q301  
2SC3356  
RX VCO

Q305  
2SC2759  
BUFF

Q302  
DTC124EK  
T/R SW

144.0-148.0MHz

Q303  
2SC3356  
TX VCO

Q305  
1SV214  
MOD

Q304  
1MHS  
T/R SW

VCO-UNIT  
F3152101A

TX +9V

Q1015  
2SB1143S  
TX +9V

Q1021  
1MHS  
T/R SW

RX +9V

Q1022  
DTA143EK  
RX +9V

Q1013  
AN6541  
+9V REG

Q2011  
1MHS  
PD ADJ SW

H/M/L

Q2001-1  
NJM2902M  
LPF

TONE

SCAN STOP

TONE SQL-UNIT  
FTS-17A  
(OPTION)

TONE SQL  
DATA

RESET

TX/RX

AF MUTE

Q2007-4  
NJM2902M  
LPF

Q2007-3  
NJM2902M  
BUFF

Q2018  
2SC2712GR  
BUFF

Q2002  
DTC114EK  
AF MUTE

+5V

Q2012  
L7805  
+5V REG

Q2006.9, 10, 15, D200  
2SC1623-L5, RH5VA45AA, DTC114EK  
RESET CIRCUIT

CNTL-UNIT F3426101

SPKR



DS3001  
FTD-10262AB (SP-2B)  
LCD

DIAL

DIAL INPUT

KE

# Block Diagram

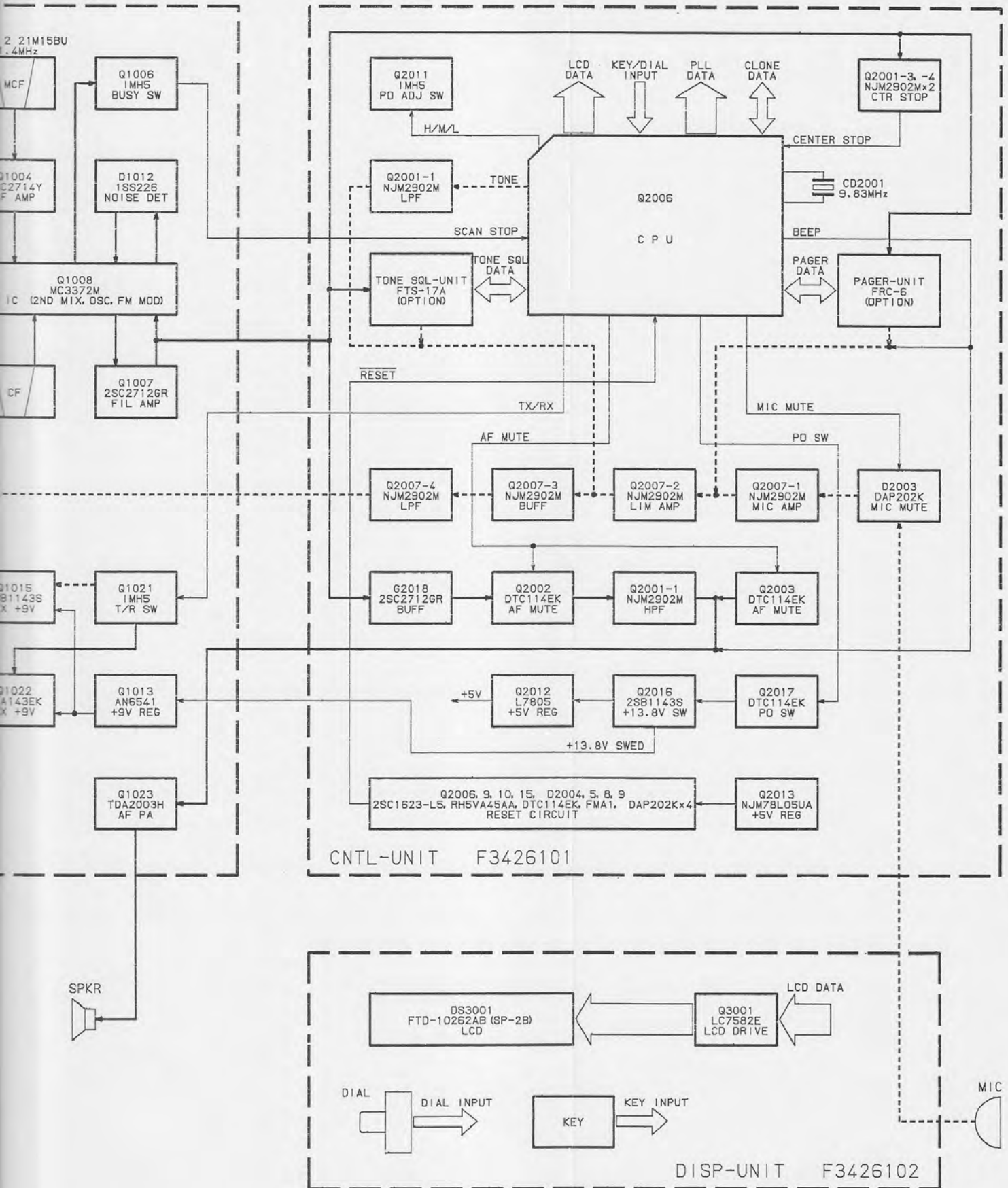

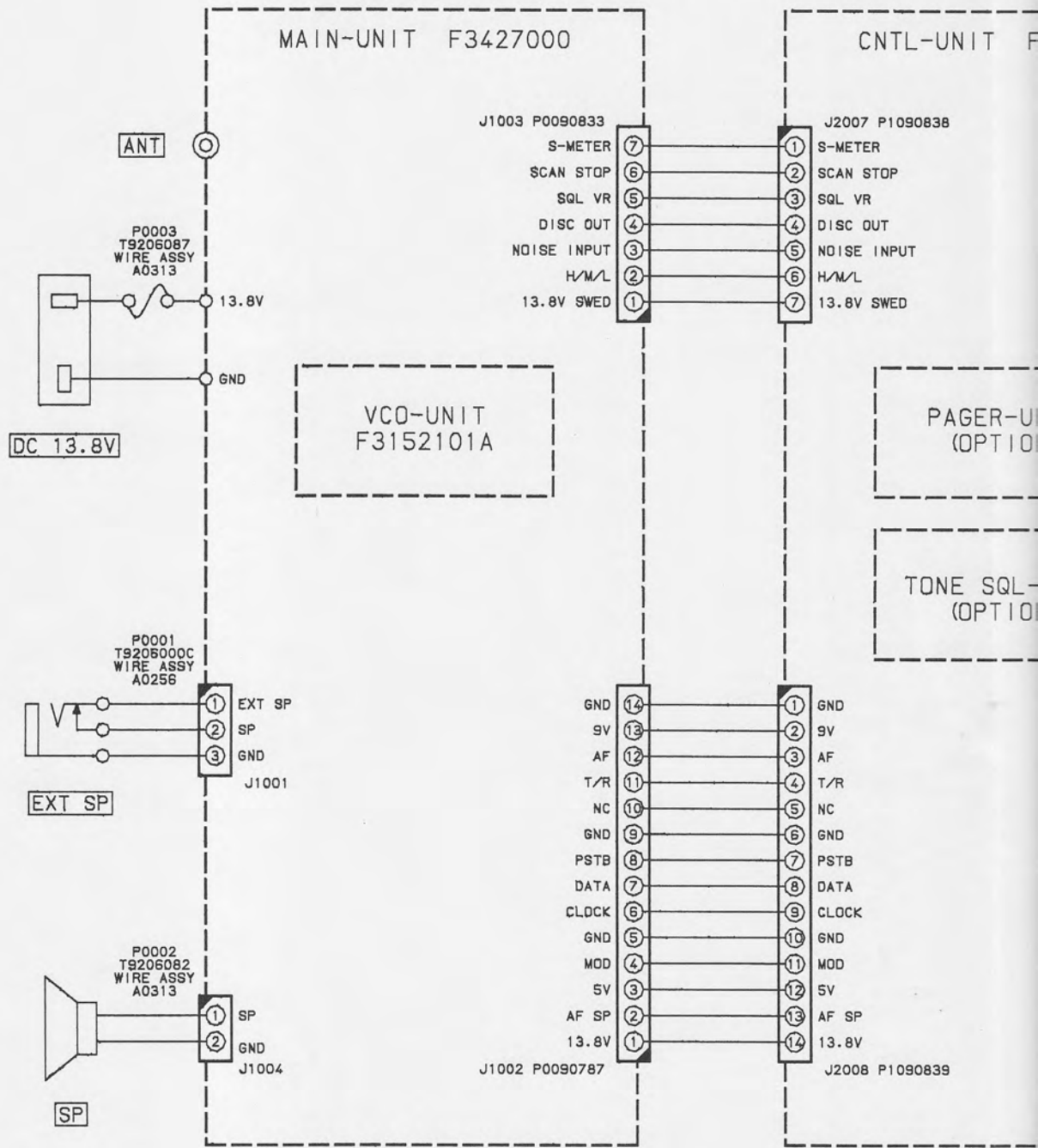



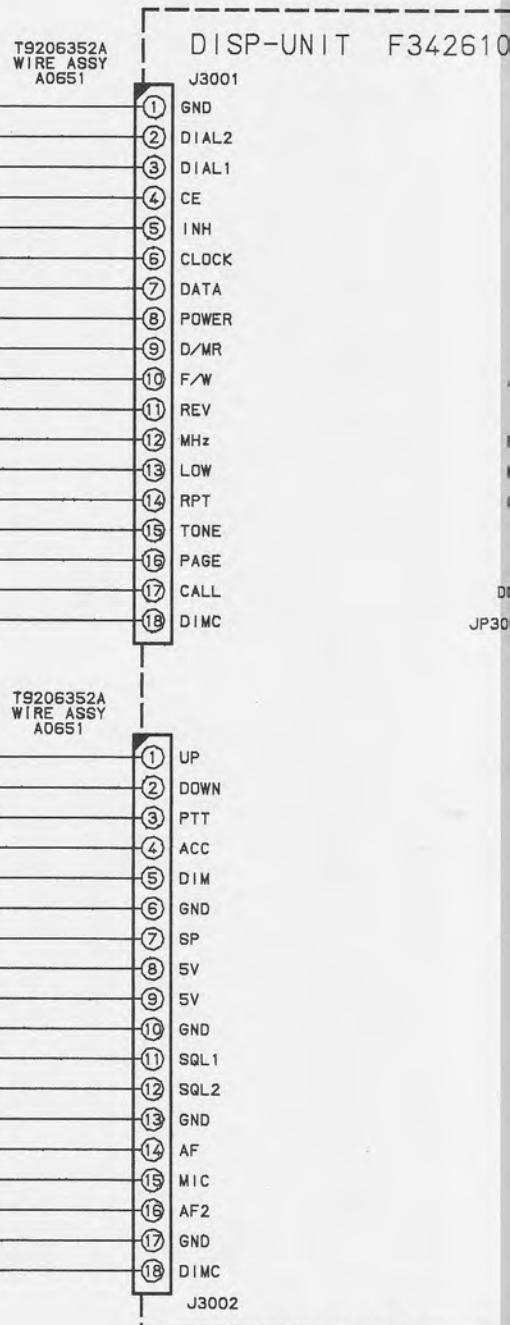
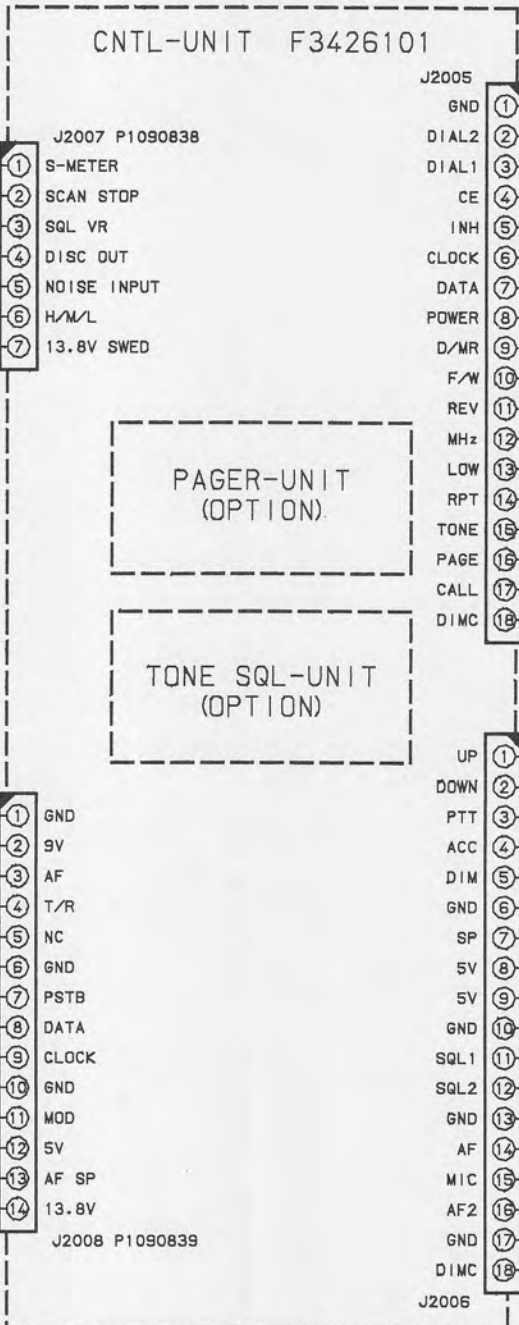
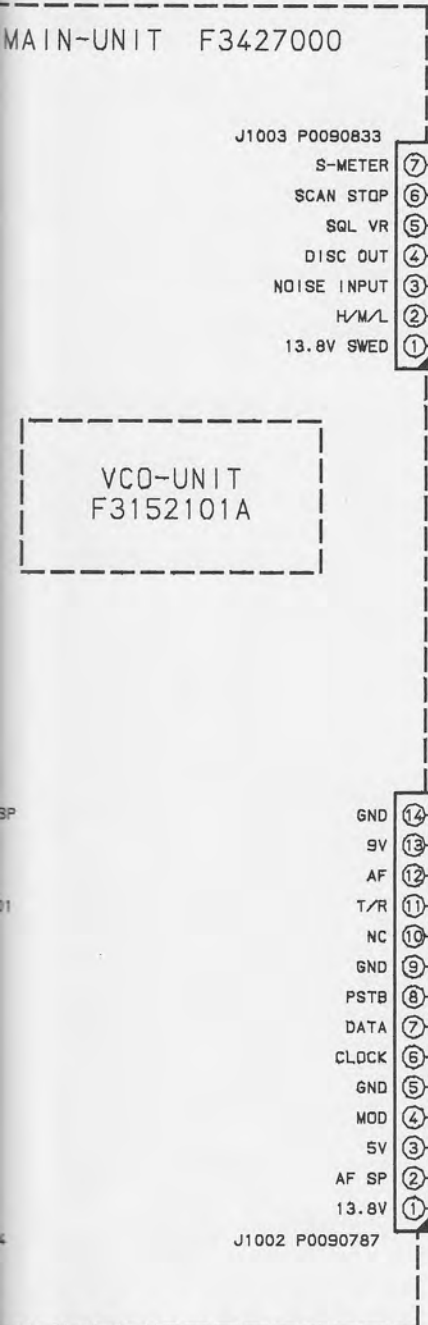

# Interconnection Diagram

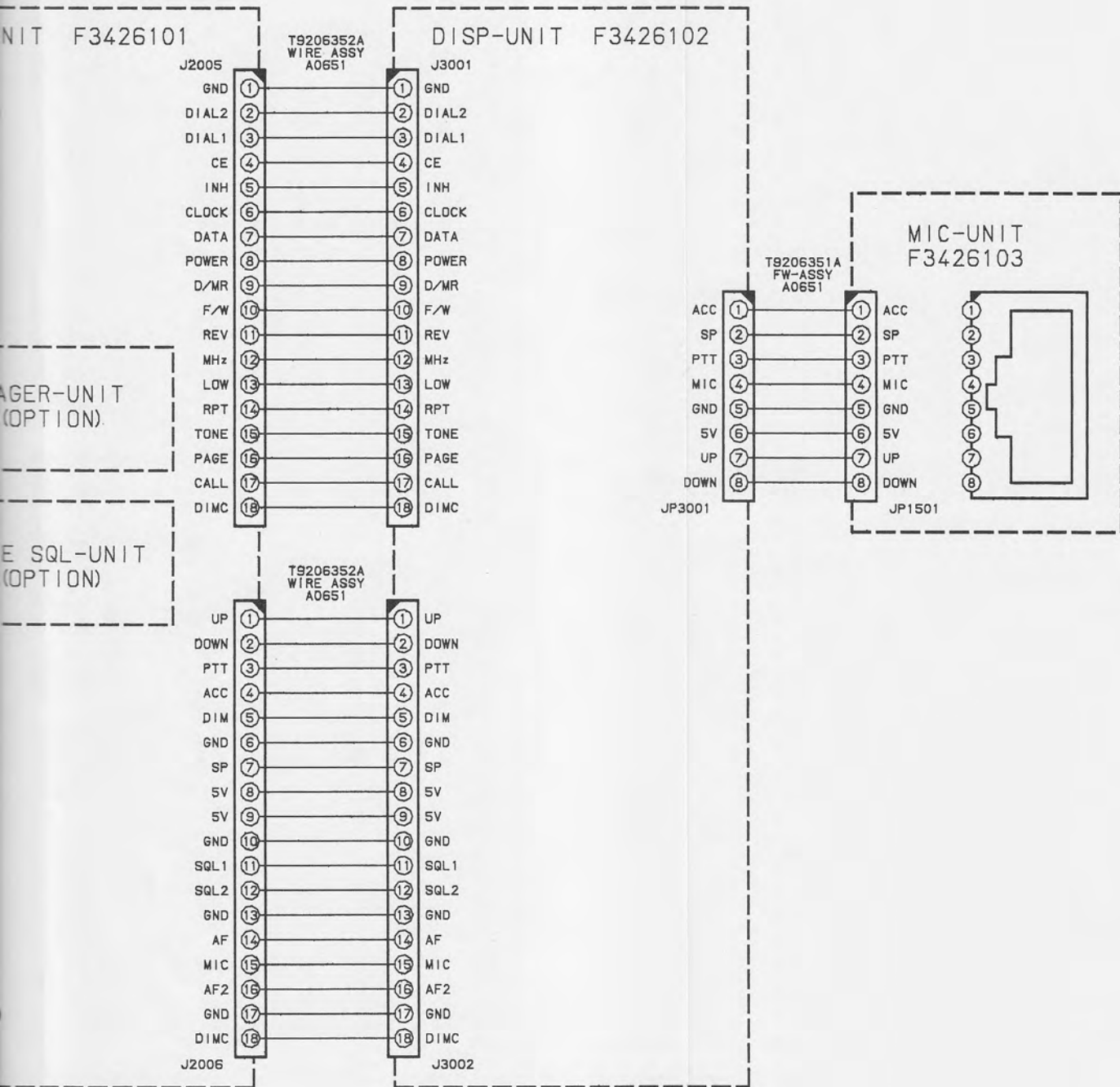

Screw List			
REF.	YAESU P/N	Description	Qty.
①	U00306001	PAN HEAD SCREW M3×6	1
②	U06408007	SCREW OM4×8B	2
③	U20206001	BINDING HEAD SCREW M2.6×6	2
④	U20306001	BINDING HEAD SCREW M3×6	1
⑤	U20306002	BINDING HEAD SCREW M3×6Ni	2
⑥	U20306007	BINDING HEAD SCREW M3×6B	8
⑦	U20308001	BINDING HEAD SCREW M3×8	2
⑧	U20308002	BINDING HEAD SCREW M3×8Ni	9
⑨	U30206001	FLAT HEAD SCREW M2.6×6	9
⑩	U30306007	FLAT HEAD SCREW M3×6B	1
⑪	U43206001	TAPTITE SCREW M2.6×6	1
⑫	U43306001	TAPTITE SCREW M3×6	4
⑬	U51425007	HEX SOCKET HEAD BOLT M4×25B	2

Basic Accessories		
YAESU P/N	Description	Qty.
Q0000008	FUSE 15A	2
T9018615A	DC CABLE	1
E06517500	OPERATING MANUAL	1

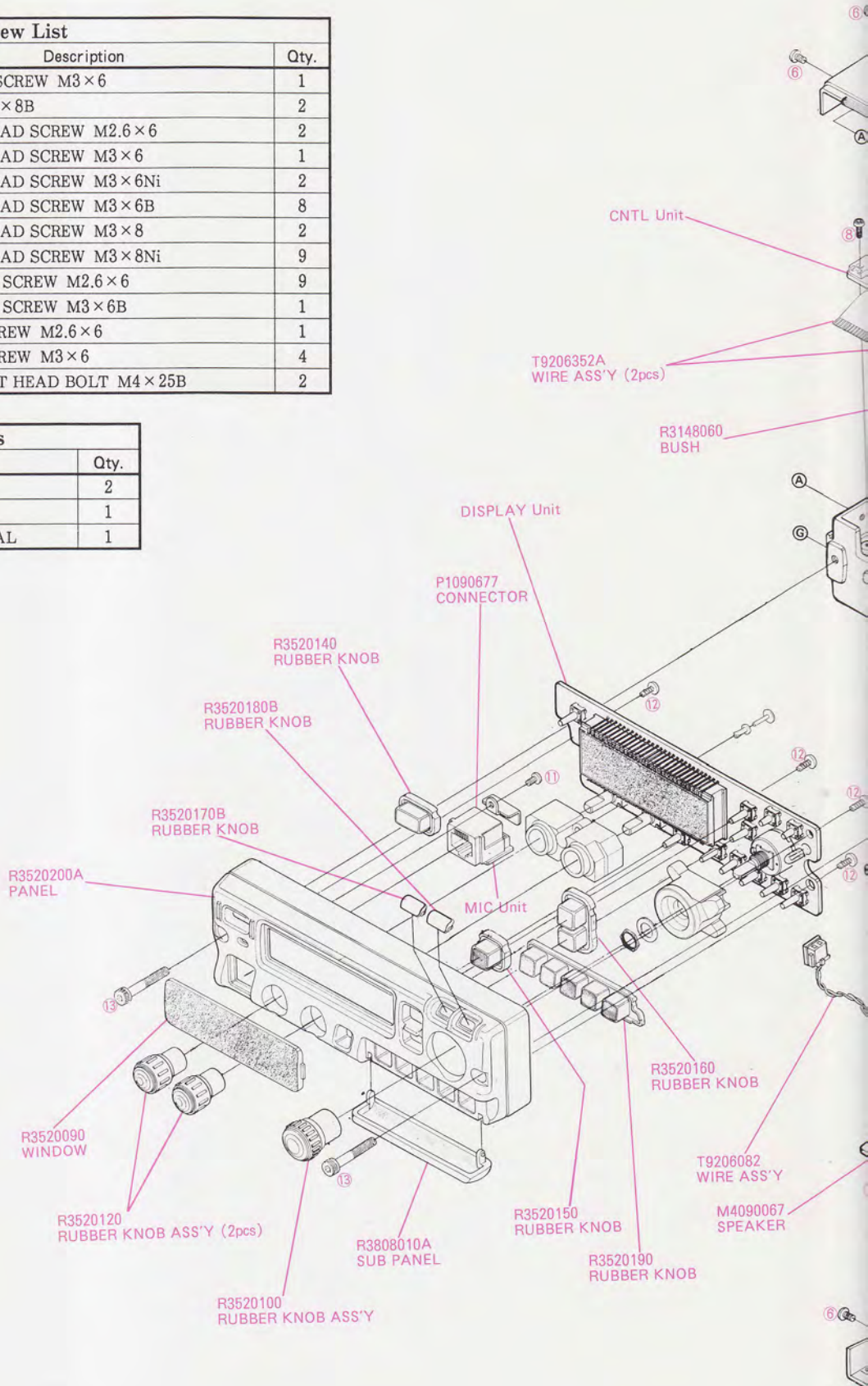

	Qty.
	1
	2
	2
	1
	2
	8
	2
	9
	9
	1
	1
	4
5B	2

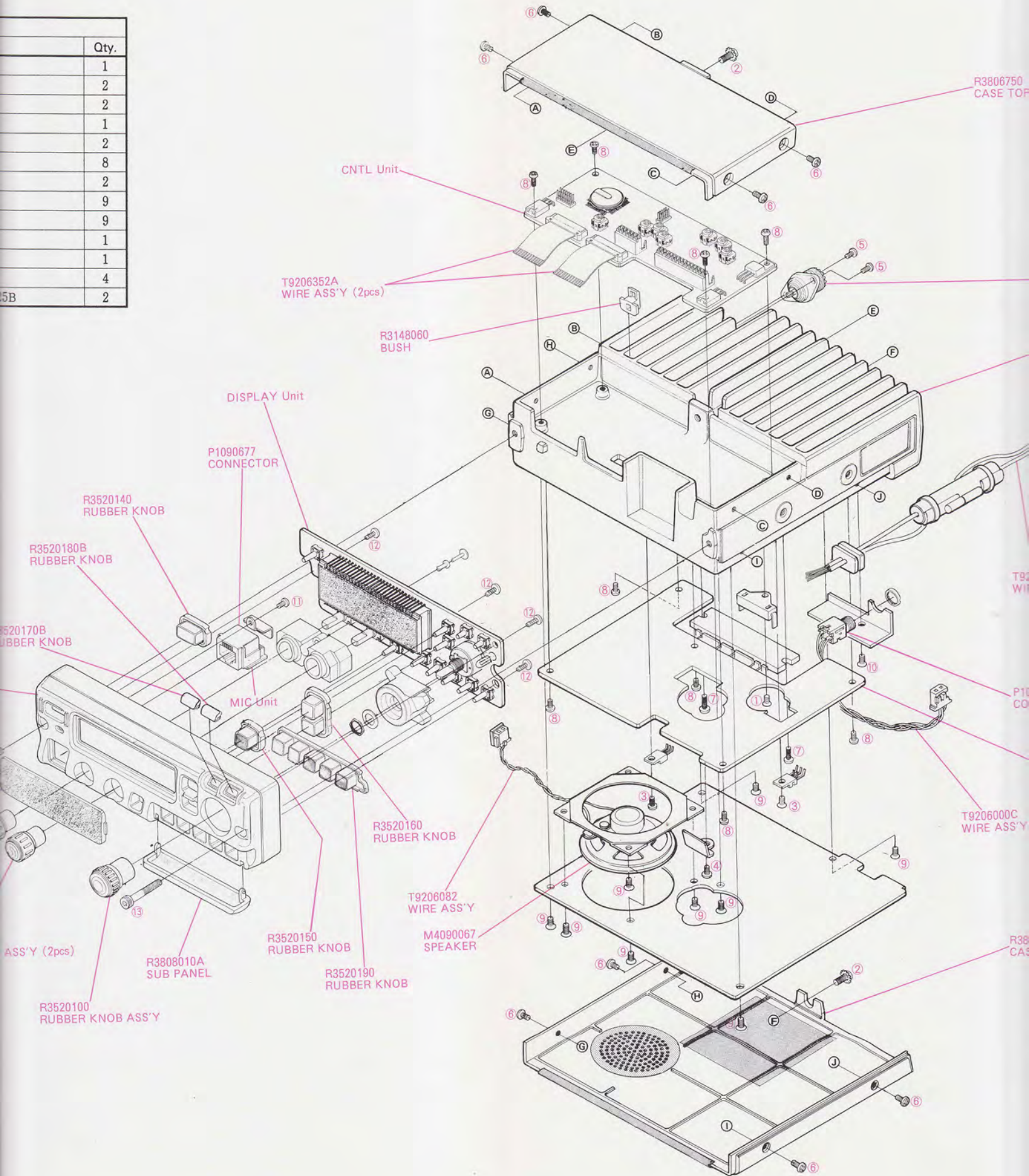

R3806750  
CASE TOP

CNTL Unit

T9206352A  
WIRE ASS'Y (2pcs)

R3148060  
BUSH

DISPLAY Unit

P1090677  
CONNECTOR

R3520140  
RUBBER KNOB

R3520180B  
RUBBER KNOB

R3520170B  
RUBBER KNOB

MIC Unit

R3520160  
RUBBER KNOB

T9206082  
WIRE ASS'Y

M4090067  
SPEAKER

ASS'Y (2pcs)

R3808010A  
SUB PANEL

R3520150  
RUBBER KNOB

R3520190  
RUBBER KNOB

R3520100  
RUBBER KNOB ASS'Y

T9206000C  
WIRE ASS'Y

R3806750  
CASE TOP

# Exploded View & Miscellaneous Parts

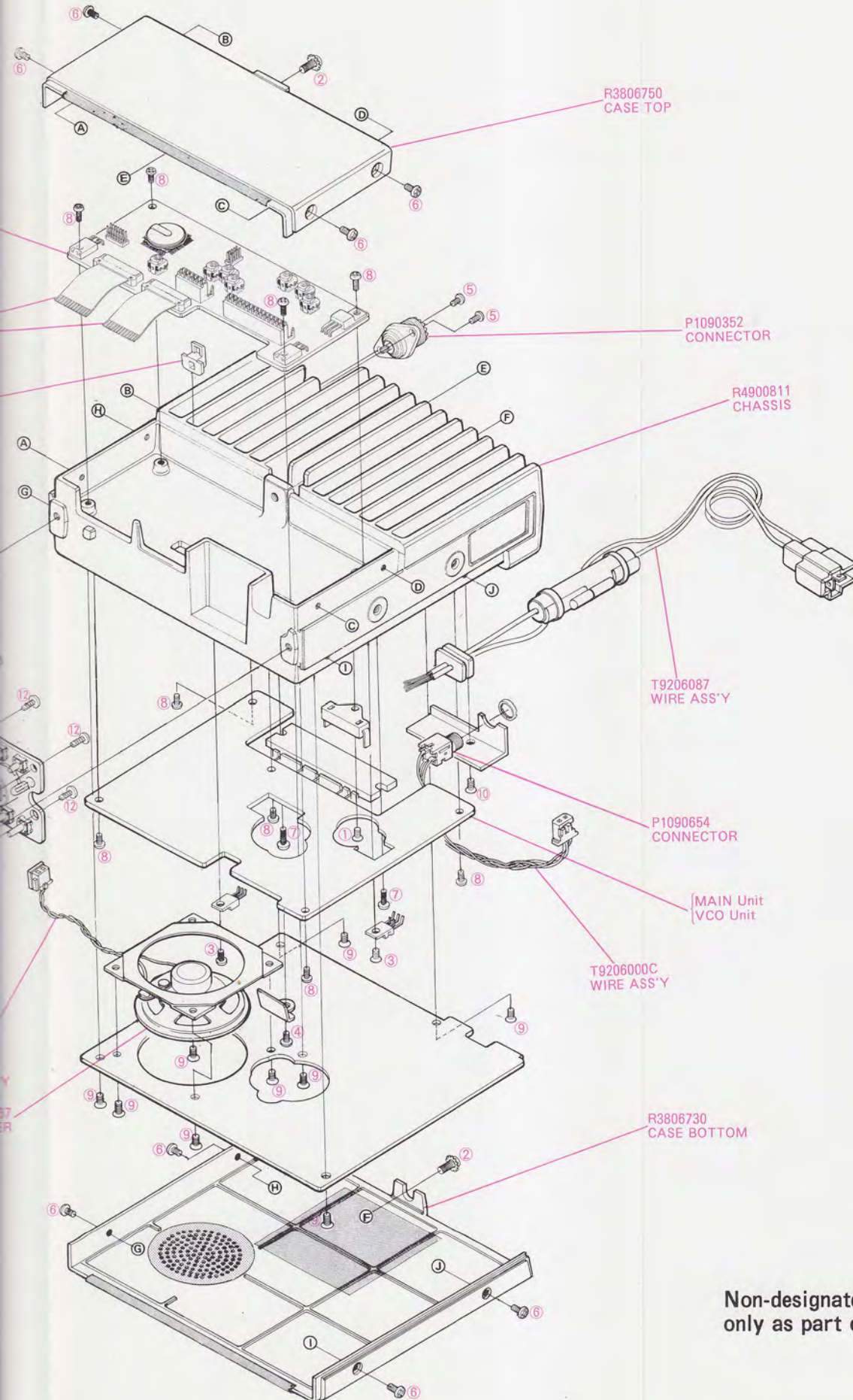

Non-designated parts are available only as part of a designated assembly.

# Case Disassembly and PCB Access

## LCD & Control Unit Access

- To access the Control Unit and Display Unit first remove the **VOL**, **SQL** and dial knobs by gently pulling them outward.



- Next remove two screws from each side of the top cover and one from the rear. Tilt the rear of the cover upward, then slide it out from the chassis. Note that the single rear screw is different from the other four, be sure to reinstall it in the correct location. Be careful not to lose the plastic plug covering the cable entrance cutout in the chassis.

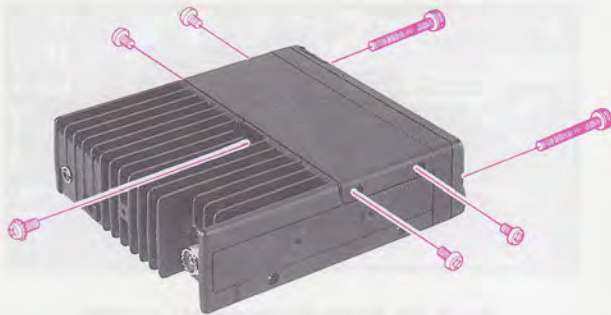

- Remove the two hex bolts from the front panel using a 3.5 mm hexagonal driver, then gently loosen the front panel.
- Remove the two flat ribbon cables by using a small screwdriver or fingernail to slide the release clamps forward on both sides of the cable connector. After releasing both cables, gently separate the front panel from the main chassis and place it on a soft surface to prevent the clear display from marring.

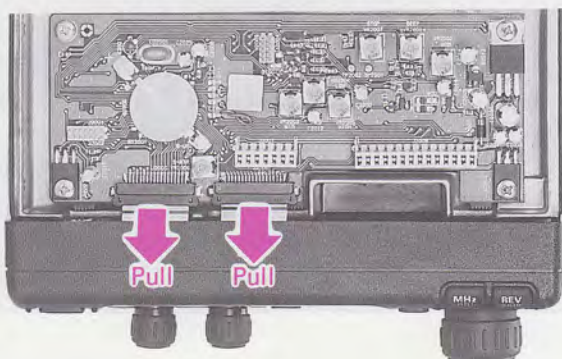

## Lithium Backup Battery Replacement

The lithium backup battery should not require servicing for a period of several years, however, to replace the cell, order Yaesu P/N Q9000552.

- First note the location and tab polarity of BT2001, mounted over the CNTL Unit micro-processor. To remove the old cell, carefully unsolder each terminal from the CNTL Unit PCB and lift it free.

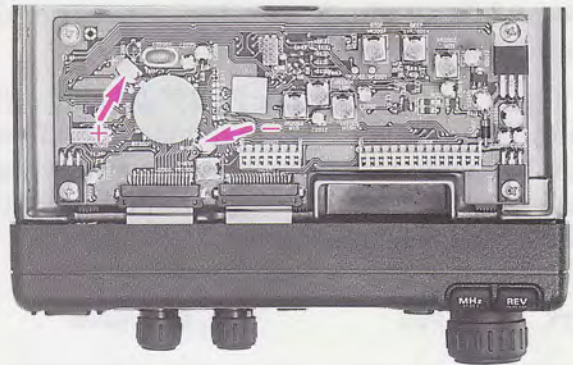

Dispose of lithium batteries according to regulations in your area, and ensure small children cannot play with or accidentally ingest the battery.

- Mount the replacement cell similarly, observing proper polarity when installing it. Next, place the plastic insulating seal (P/N R8118690) on top of the cell by peeling back the cover to expose the adhesive backing, then pressing it in place.

## Panel Lamp Replacement

The LCD and controls are illuminated by four 10-V incandescent miniature lamps. If these require replacement, they can be ordered from your Yaesu dealer (P/N Q1000083).

- First remove the front panel as previously described. Note the location of the four lamps, as indicated below.

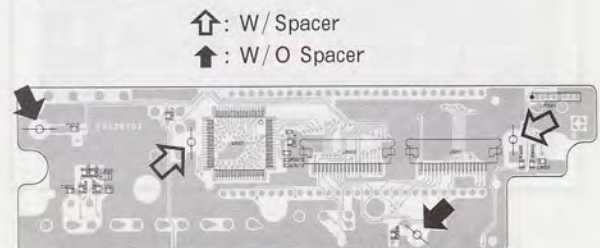

- To remove a failed lamp, use a low wattage soldering iron and forceps to unsolder and free each lead, then gently lift the bulb out of the hole.

# Modification for 9600-Baud Packet

*Note:* The two lamps on either side of the LCD use plastic spacers, be careful not to lose these when removing the bulb, and insert them again when installing a new bulb.

- Install replacement bulbs in the reverse manner, then reassemble the transceiver case.

## Modification for 9600-Baud Packet

Operation at high data rates requires special interfacing since the FT-2500M bandwidth and pre- and de-emphasis circuitry are not optimized for this mode of operation.

If you want to use your FT-2500M with a 9600-baud Packet TNC, the following modification should enable better performance at this higher data rate. However, throughput performance at 9600 baud is not guaranteed.

QTY.	Part	Comments
2 pc.	0-Ω chip resistor	*Read notice at below right.
1 pc.	10-kΩ chip resistor	You may have to experiment with this value for optimum audio input level.
2 pc.	lengths of wire	Use stranded #22 AWG, approx. 5 cm in length.
2 pc.	1-μF tantalum chip capacitor	If your TNC model does not have a capacitive-coupled audio input/output, see the notice below.

If you choose to perform this modification, you will need a low-wattage soldering iron, tweezers and the following components:

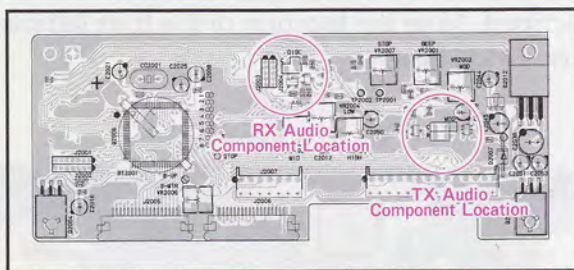

Fig. 1 Modification Component Location

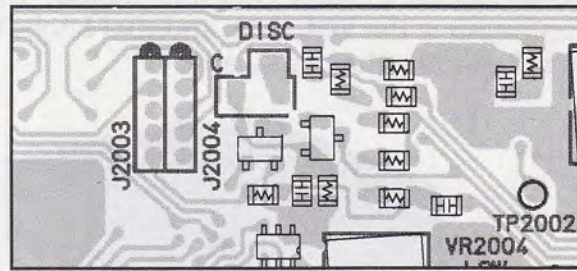

Fig. 2 RX Audio Component Location

*If you are not confident at surface mount soldering, do not attempt the modification, and contact your Yaesu dealer for assistance.*

- Remove the top cover as described on the previous page to expose the CNTL Unit. Refer to Fig. 1 to familiarize yourself with the part locations.

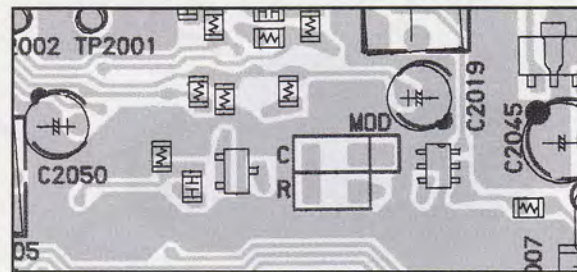

Fig. 3 TX Audio Component Location

- Locate the unused pad beneath connector J2004, labeled **C** (Fig. 2). Install a 0-Ω chip resistor\* across at this location, and a wire to the pad just to the left labeled **DISC**. This makes the connection for de-emphasized discriminator audio output for decoding.

### Notice!

If your TNC does not use a coupling capacitor in-line for transceiver audio connections, you will need to substitute 1-μF tantalum chip capacitors in place of the 0-Ω chip resistors. Refer to your TNC documentation to determine correct placement for proper polarity.

## Modification for 9600-Baud Packet

- Next locate the set of pads labeled **MOD (C & R)**, above connector J2008 (fig. 3). Solder a 10-k $\Omega$  chip resistor across pad **R**, and a 0- $\Omega$  chip resistor\* across pad **C**, and a wire lead to the adjacent pad. Pre-emphasized audio is fed to the transmitter here.
- Note the small plastic plug in the chassis cut-out at the rear left corner of the CNTL Unit compartment. Remove this plug, then run the leads from your TNC through this cut-out and solder them to the appropriate leads on the CNTL Unit. Be sure to insulate any spliced leads with heat-shrink tubing or electrical tape.
- After checking all connections for integrity, replace the top cover and tighten all screws. This completes the modification.

*While this modification should work with most units, experimentation with audio input and output level may be necessary before optimum performance is obtained.*

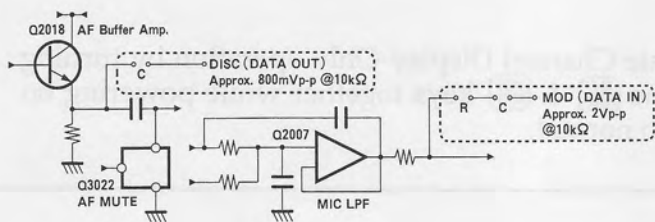

Fig. 4 TNC DATA IN/OUT Lead Connections



## Channel Display-Only Mode

### Channel Display-Only Mode

You can use this feature when you need very simple operation: only stored memories can be selected, and are displayed as "CH. 1, 2,..." instead of the channel frequency or alphanumeric name display. Indicators for *previously stored* settings such as repeater shift and tone squelch are still displayed, although they cannot be changed. Only the settings listed below can be changed as described

- ✗ High/Mid/Low TX power and locking function: use **LOW LOCK** (**F/W**) ⇒ **LOW LOCK** to toggle
- ✗ Volume & Squelch: same as before
- ✗ Channel Selection: DIAL knob or microphone **UP/DWN** keys
- ✗ Paging function selection: toggle **PAGE CODE** to select paging mode
- ✗ Paging code memory selection: press **F/W** ⇒ **PAGE CODE** and rotate DIAL knob to select
- ✗ CALL channel instant recall: press **CALL BELL** to toggle
- ✗ Priority channel recall: press **MHZ PRI** to toggle

After programming memories, you can activate Channel Display-Only operation by turning the transceiver off, then pressing and holding the **D/MR** & **A/N STEP** keys together while powering on again. Repeat this step to return the transceiver to normal.

The FT-2500M has been carefully aligned at the factory for the specified performance across the amateur band. Realignment should therefore not be necessary except in the event of a component failure. All component replacement and service should be performed only by an authorized Yaesu representative, or the warranty policy may be voided.

The following procedures cover the sometimes critical and tedious adjustments that are not normally required once the transceiver has left the factory. However, if damage occurs and some parts are replaced, realignment may be required. If a sudden problem occurs during normal operation, it is likely due to component failure; realignment should not be done until after the faulty component has been replaced.

We recommend that servicing be performed only by authorized Yaesu service technicians who are experienced with the circuitry and fully

equipped for repair and alignment. Therefore, if a fault is suspected, contact the dealer from whom the transceiver was purchased for instructions regarding repair. Authorized Yaesu service technicians realign all circuits and make complete performance checks to ensure compliance with factory specifications after replacing any faulty components.

Those who do undertake any of the following alignments are cautioned to proceed at their own risk. Problems caused by unauthorized attempts at realignment are not covered by the warranty policy. Also, Yaesu must reserve the right to change circuits and alignment procedures in the interest of improved performance, without notifying owners.

Under no circumstances should any alignment be attempted unless the normal function and operation of the transceiver are clearly understood, the cause of the malfunction has been

## Case Disassembly

- ❑ Make sure the transceiver is off. Remove the two screws from each side of the top and bottom covers, then loosen the two rear screws. Next remove the top and bottom covers, the CNTL Unit is now accessible from the top of the chassis.
- ❑ To expose the Main Unit PCB on the bottom of the transceiver chassis, remove the 5 screws affixing the shield cover plate, and remove the cover.

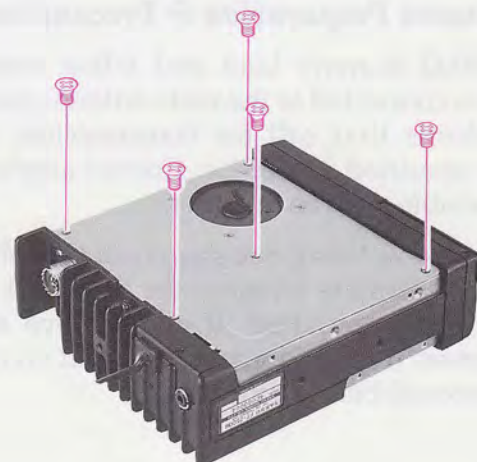
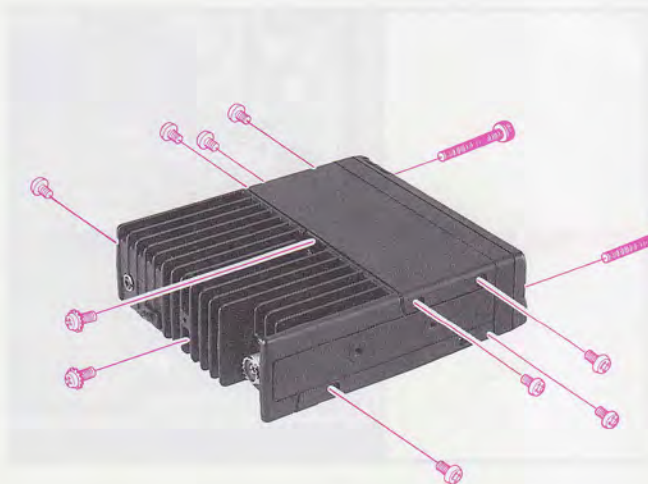
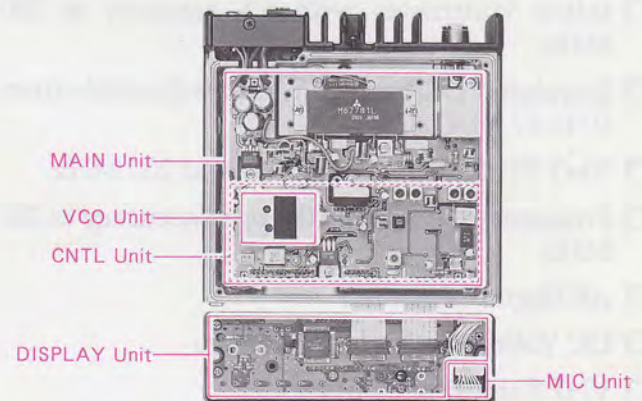

# Alignment

clearly pinpointed and any faulty components replaced, and the need for realignment determined to be absolutely necessary.

The following test equipment (and thorough familiarity with its correct use) is necessary for complete realignment. Correction of problems caused by misalignment resulting from use of improper test equipment is not covered under the warranty policy. While most steps do not require all of the equipment listed, the interactions of some adjustments may require that more complex adjustments be performed afterwards. Do not attempt to perform only a single step unless it is clearly isolated electrically from all other steps. Have all test equipment ready before beginning, and follow all of the steps in a section in the order presented.

## Required Test Equipment

- RF Signal Generator with calibrated output level at 200 MHz
- Deviation Meter (linear detector)
- AF Millivoltmeter
- SINAD Meter
- Inline Wattmeter with 5% accuracy at 200 MHz
- Regulated DC Power Supply: adjustable from 10 to 17 VDC, 15A
- 50-Ω RF Dummy Load: 100W at 200 MHz
- Frequency Counter:  $\pm 0.1$  ppm accuracy at 200 MHz
- AF Signal Generator
- DC Voltmeter: high impedance
- VHF Sampling Coupler
- AF Dummy Load: 8 Ω, 5W

## Alignment Preparation & Precautions

A 50-Ω dummy load and inline wattmeter must be connected to the main antenna jack in all procedures that call for transmission, except where specified otherwise. Correct alignment is not possible with an antenna.

After completing one step, read the following step to determine whether the same test equipment will be required. If not, remove the test equipment (except dummy load and wattmeter, if connected) before proceeding.

Correct alignment requires that the ambient temperature be the same as that of the transceiver and test equipment, and that this temperature be held constant between 20° and 30° C (68° ~ 86 °F). When the transceiver is brought into the shop from hot or cold air it should be allowed some time for thermal equalization with the environment before alignment.

If possible, alignments should be made with oscillator shields and circuit boards firmly affixed in place. Also, the test equipment must be thoroughly warmed up before beginning.

*Note:* Signal levels in dB referred to in this procedure are based on 0 dBμ = 0.5 μV(closed circuit).

## PLL & Transmitter

Set up the test equipment as shown for transmitter alignment. Maintain the supply voltage at 13.8V DC for all steps.

### PLL & Transmitter Alignment Setup

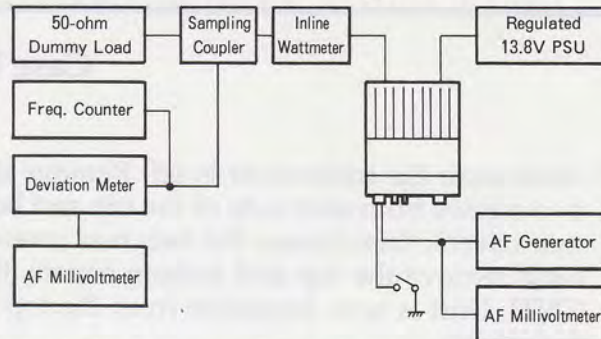

### PLL VCV (Varactor Control Voltage)

- Connect the positive lead of the DC voltmeter to the test point VCV on the Main Unit, as indicated in the figure, and the negative lead to chassis ground.

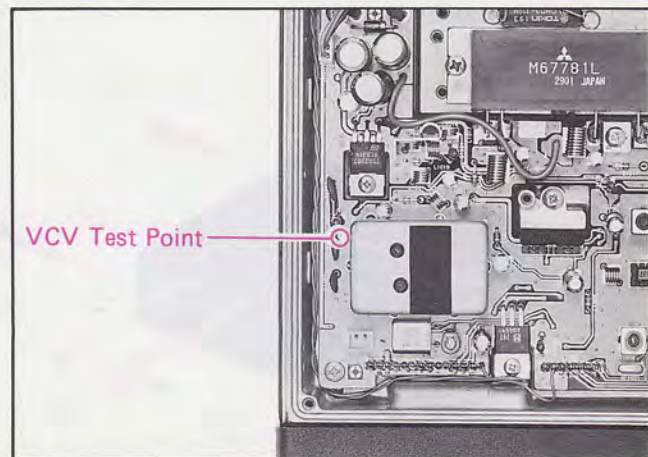

## PLL & Transmitter Alignment Points

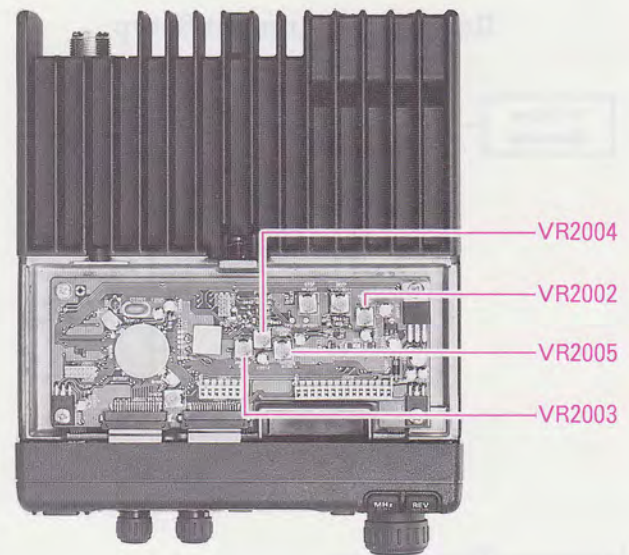
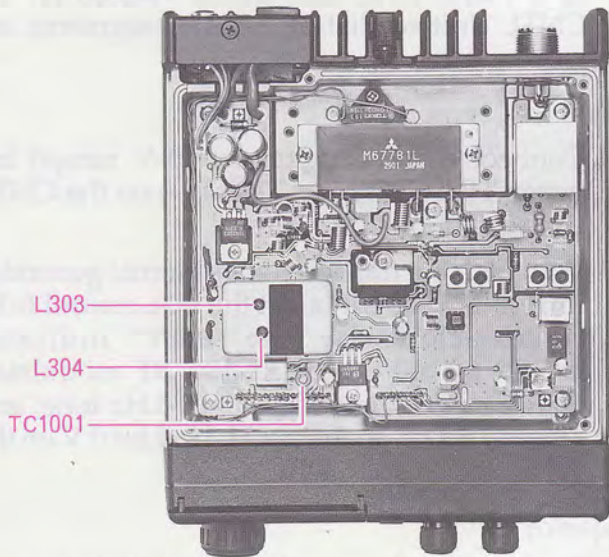

- Set the transceiver to the 174.000 MHz\*, and adjust coil L303 on the VCO Unit for 7.5 V on the voltmeter.

*\*For transceiver versions without extended receive capability, tune to 146.000 MHz and adjust L303 for 1.8 V on the voltmeter.*

- Next tune to 146.000 MHz, key the transmitter, and adjust L304 for 1.8 V on the voltmeter.

### PLL Reference Frequency

- With the wattmeter, dummy load and frequency counter connected to the antenna jack, and while tuned to 146.000 MHz, key the transmitter and adjust TC1001 on the Main Unit, if necessary, so the counter frequency is within 100 Hz of 146.000 MHz.

### Transmitter Output

- Preset trimmer potentiometers VR2003, VR2004 and VR2005 fully clockwise.
- While tuned to 146.000 MHz, press the **LOW** button on the panel to select high, mid- and then low power while adjusting the corresponding trimpot for the transmitter power output levels listed in the table:

Panel Power Selection	Adjustment	Power Output
High	VR2005	50 ± 5W
Mid	VR2003	25 ± 1W
Low	VR2004	5 ± 1W

### Transmitter Deviation

- While tuned to 146.000 MHz, adjust the AF generator level for 50 mV output @ 1 kHz to the **MIC** jack.
- Key the transmitter and adjust VR2002 on the CNTL Unit for ± 4.5 kHz deviation on the deviation meter (within 100 Hz).

# Alignment

## Receiver

Set up the test equipment as shown below for receiver alignment.

### Receiver Alignment Setup

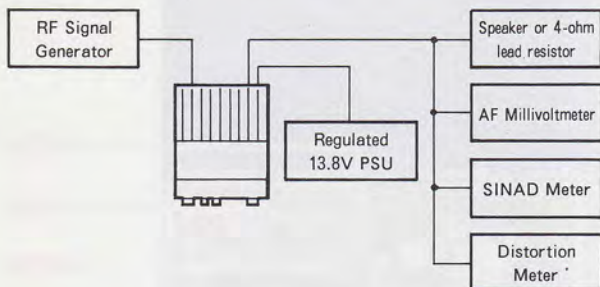

### Interstage Transformers

- Connect the DC voltmeter between J1003 pin 7 and chassis ground.
- Modulate the RF signal generator with  $\pm 3.5$  kHz deviation of a 1-kHz tone.
- Adjust T1001 ~ T1004, & T1006 on the Main Unit for maximum voltage on the meter, then once again for optimum SINAD (at least -7 dB $\mu$  for 12 dB SINAD).

### S-Meter Calibration

- While tuned to 146.000 MHz, inject a +25 dB $\mu$  RF signal modulated with  $\pm 3.5$  kHz deviation of a 1-kHz tone, and adjust VR2006 on the CNTL Unit so that all S-meter segments are just on.

### Scanner Center Stop

- Connect the DC voltmeter (3-V range) between TP2002 (+) and TP2001(-) on the CNTL Unit.
- With both the transceiver and signal generator tune to 146.000 MHz, set the **SQL** control fully counter-clockwise (the "**BUSY**" indicator should be on). Inject 20 dB $\mu$  RF modulated with  $\pm 3.5$  kHz deviation of a 1-kHz tone, and adjust VR2007 on the CNTL Unit for 0 V on the voltmeter.

### Squelch

- Preset the **SQL** control to the 10 o'clock position. At the center of the band, tune the RF signal generator to the same frequency, and set the generator level to -12 dB $\mu$ .
- Turn VR1001 clockwise until the squelch just closes, and then counter-clockwise very slightly so that it just opens.

### Receiver Alignment Points

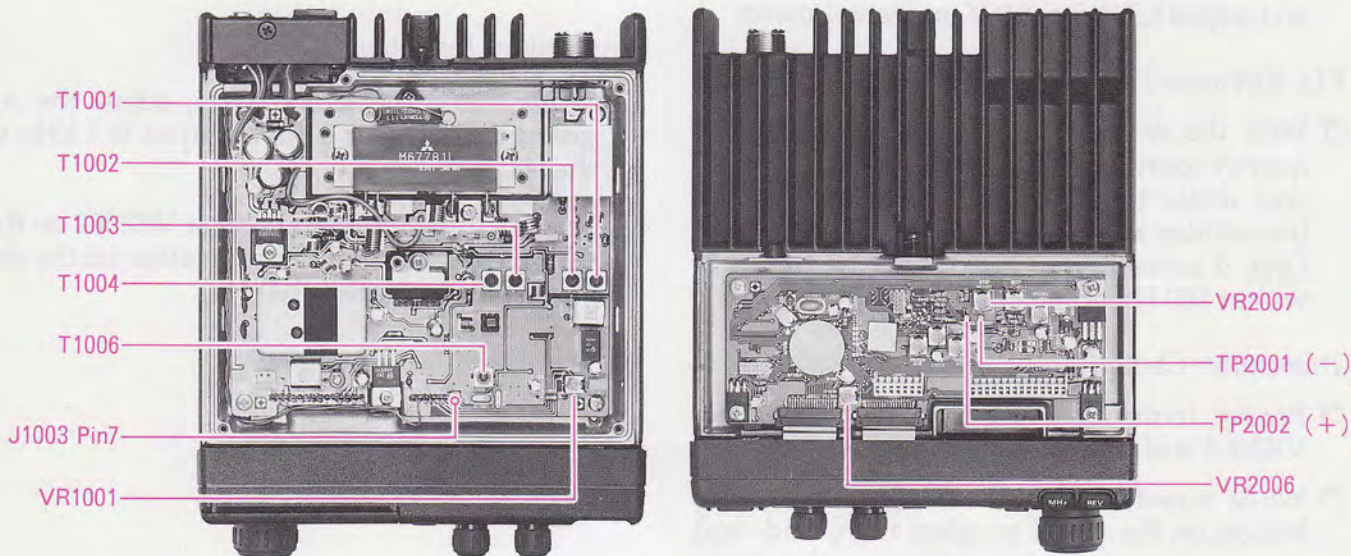

# VCO Unit

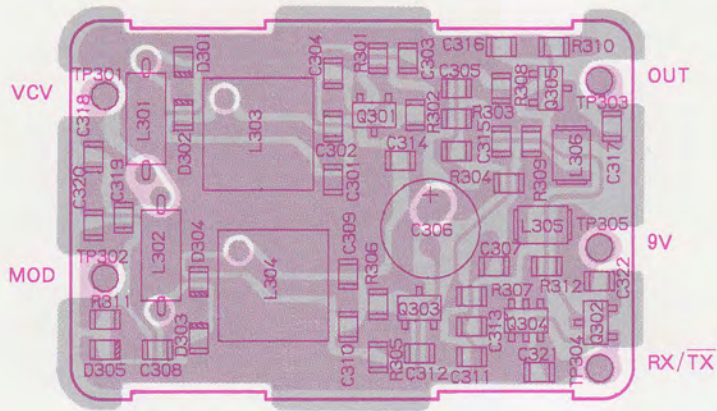

component side

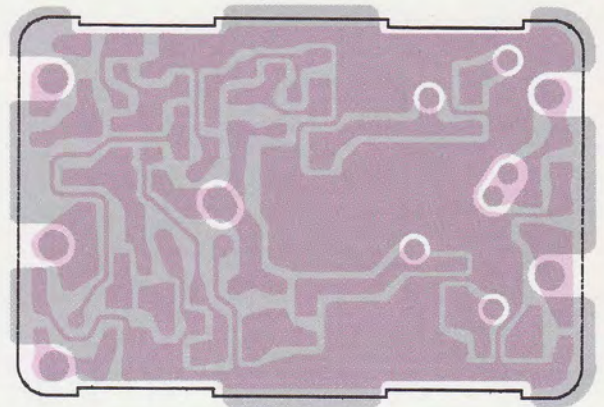

chip-only side

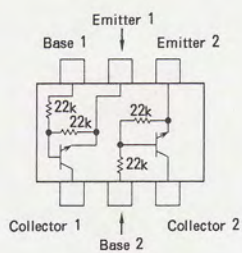

IMH5 (H5)  
(Q304)

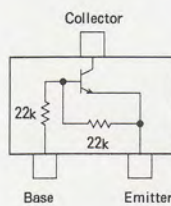

DTC124EK (25)  
(Q302)

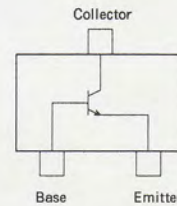

2SC2759 (U22)  
(Q305)  
2SC3356 (R24)  
(Q301,303)

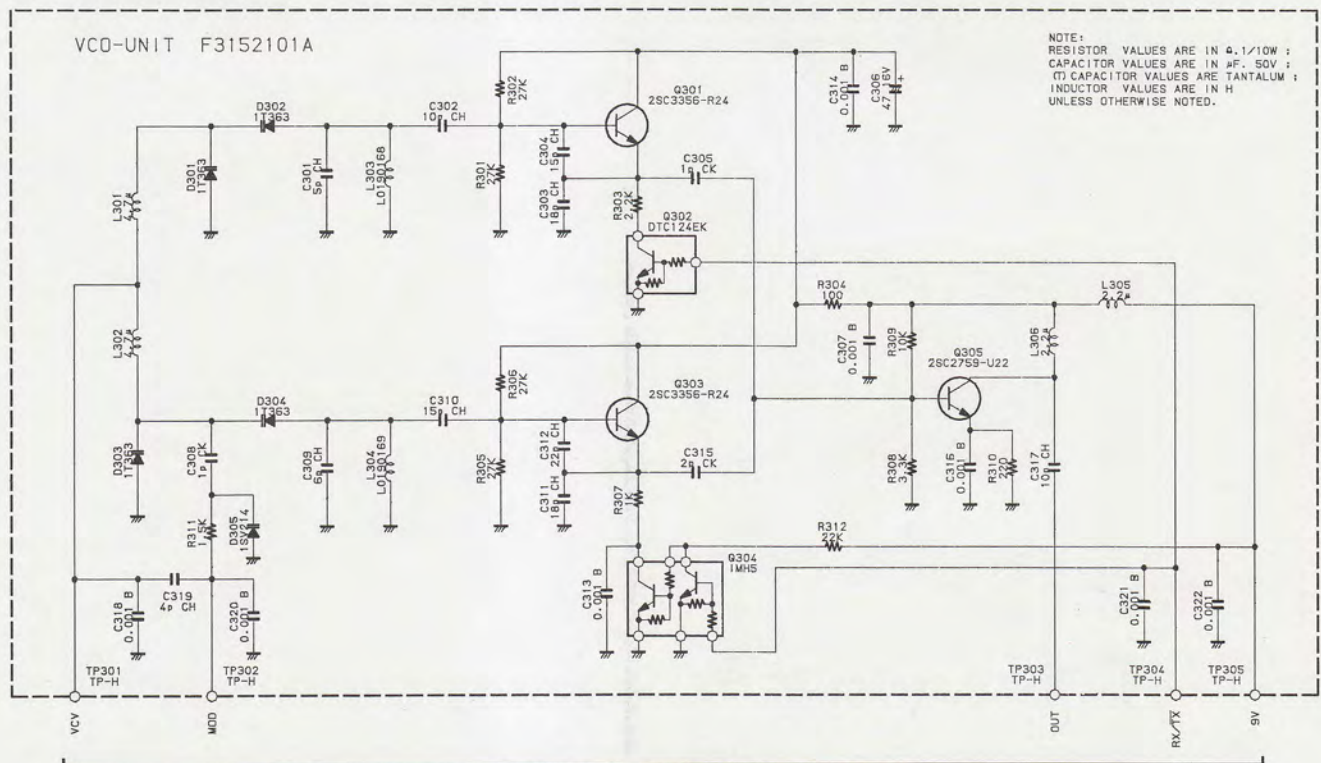

NOTE:  
RESISTOR VALUES ARE IN  $\Omega$ , 1/10W ;  
CAPACITOR VALUES ARE IN  $\mu$ F, 50V ;  
(T) CAPACITOR VALUES ARE TANTALUM ;  
INDUCTOR VALUES ARE IN H  
UNLESS OTHERWISE NOTED.

To MAIN Unit (See Page 3B-1)

# VCO Unit

REF.	DESCRIPTION	VALUE	WV	TOL.	MFR'S DESIG	YAESU P/N	VERS.
*** VCO UNIT ***							
	PCB With Components					CA1305001	
	Printed Circuit Board					F3152101A	
C 0301	CHIP CAP.	5pF	50V	CH	GRM40CH050C50PT	K22170206	
C 0302	CHIP CAP.	10pF	50V	CH	GRM40CH100D50PT	K22170211	
C 0303	CHIP CAP.	18pF	50V	CH	GRM40CH180J50PT	K22170217	
C 0304	CHIP CAP.	15pF	50V	CH	GRM40CH150J50PT	K22170215	
C 0305	CHIP CAP.	1pF	50V	CK	GRM40CK010C50PT	K22170202	
C 0306	AL. ELECTRO. CAP.	47uF	16V		16V470M6X7TR2	K46120006	
C 0307	CHIP CAP.	0.001uF	50V	B	GRM40B102M50PT	K22170805	
C 0308	CHIP CAP.	1pF	50V	CK	GRM40CK010C50PT	K22170202	
C 0309	CHIP CAP.	6pF	50V	CH	GRM40CH060D50PT	K22170207	
C 0310	CHIP CAP.	15pF	50V	CH	GRM40CH150J50PT	K22170215	
C 0311	CHIP CAP.	18pF	50V	CH	GRM40CH180J50PT	K22170217	
C 0312	CHIP CAP.	22pF	50V	CH	GRM40CH220J50PT	K22170219	
C 0313	CHIP CAP.	0.001uF	50V	B	GRM40B102M50PT	K22170805	
C 0314	CHIP CAP.	0.001uF	50V	B	GRM40B102M50PT	K22170805	
C 0315	CHIP CAP.	2pF	50V	CK	GRM40CK020C50PT	K22170203	
C 0316	CHIP CAP.	0.001uF	50V	B	GRM40B102M50PT	K22170805	
C 0317	CHIP CAP.	10pF	50V	CH	GRM40CH100D50PT	K22170211	
C 0318	CHIP CAP.	0.001uF	50V	B	GRM40B102M50PT	K22170805	
C 0319	CHIP CAP.	4pF	50V	CH	GRM40CH040C50PT	K22170205	
C 0320	CHIP CAP.	0.001uF	50V	B	GRM40B102M50PT	K22170805	
C 0321	CHIP CAP.	0.001uF	50V	B	GRM40B102M50PT	K22170805	
C 0322	CHIP CAP.	0.001uF	50V	B	GRM40B102M50PT	K22170805	
D 0301	DIODE				1T363-01-T08A	G2070114	
D 0302	DIODE				1T363-01-T08A	G2070114	
D 0303	DIODE				1T363-01-T08A	G2070114	
D 0304	DIODE				1T363-01-T08A	G2070114	
D 0305	DIODE				1SV214 TPH	G2070356	
L 0301	M. RFC	4.7uH			LAL03NA4R7K	L1190203	
L 0302	M. RFC	4.7uH			LAL03NA4R7K	L1190203	
L 0303	COIL				S7-T2 R12-K868C	L0190168	
L 0304	COIL				S7-T2 R12-K868B	L0190169	
L 0305	M. RFC	2.2uH			FLC32T-2R2K	L1690207	
L 0306	M. RFC	2.2uH			FLC32T-2R2K	L1690207	
Q 0301	TRANSISTOR				2SC3356-T2B R24	G3333567D	
Q 0302	TRANSISTOR				DTC124EK T97	G3070034	
Q 0303	TRANSISTOR				2SC3356-T2B R24	G3333567D	
Q 0304	TRANSISTOR				1MH5 T108	G3070027	
Q 0305	TRANSISTOR				2SC2759-T2B U22	G3327597B	
R 0301	CHIP RES.	27K	1/10W	5%	RMC1/10T 273J	J24205273	
R 0302	CHIP RES.	27K	1/10W	5%	RMC1/10T 273J	J24205273	
R 0303	CHIP RES.	2.2K	1/10W	5%	RMC1/10T 222J	J24205222	
R 0304	CHIP RES.	100	1/10W	5%	RMC1/10T 101J	J24205101	
R 0305	CHIP RES.	27K	1/10W	5%	RMC1/10T 273J	J24205273	
R 0306	CHIP RES.	27K	1/10W	5%	RMC1/10T 273J	J24205273	
R 0307	CHIP RES.	1K	1/10W	5%	RMC1/10T 102J	J24205102	

# VCO Unit

REF.	DESCRIPTION	VALUE	WV	TOL.	MFGR'S DESIG	YAESU P/N	VERS.
R 0308	CHIP RES.	3.3K	1/10W	5%	RMC1/10T 332J	J24205332	
R 0309	CHIP RES.	10K	1/10W	5%	RMC1/10T 103J	J24205103	
R 0310	CHIP RES.	220	1/10W	5%	RMC1/10T 221J	J24205221	
R 0311	CHIP RES.	1.5K	1/10W	5%	RMC1/10T 152J	J24205152	
R 0312	CHIP RES.	22K	1/10W	5%	RMC1/10T 223J	J24205223	
TP0301	TP-H				MK-10160	Q5000037	
TP0302	TP-H				MK-10160	Q5000037	
TP0303	TP-H				MK-10160	Q5000037	
TP0304	TP-H				MK-10160	Q5000037	
TP0305	TP-H				MK-10160	Q5000037	
	SHIELD CASE					R0136240B	









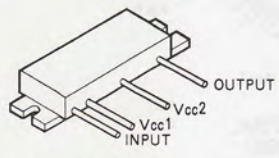

M67781L  
(Q1009)

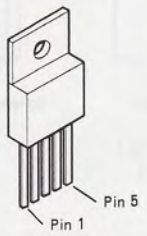

TDA2003H  
(Q1023)

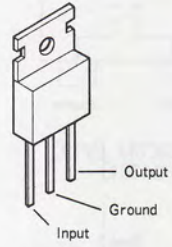

AN6541  
(Q1013)

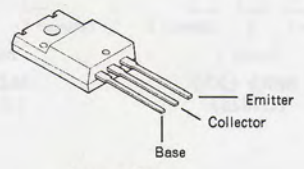

2SB1143S  
(Q1015,1019)

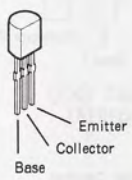

2SC2053  
(Q1010)

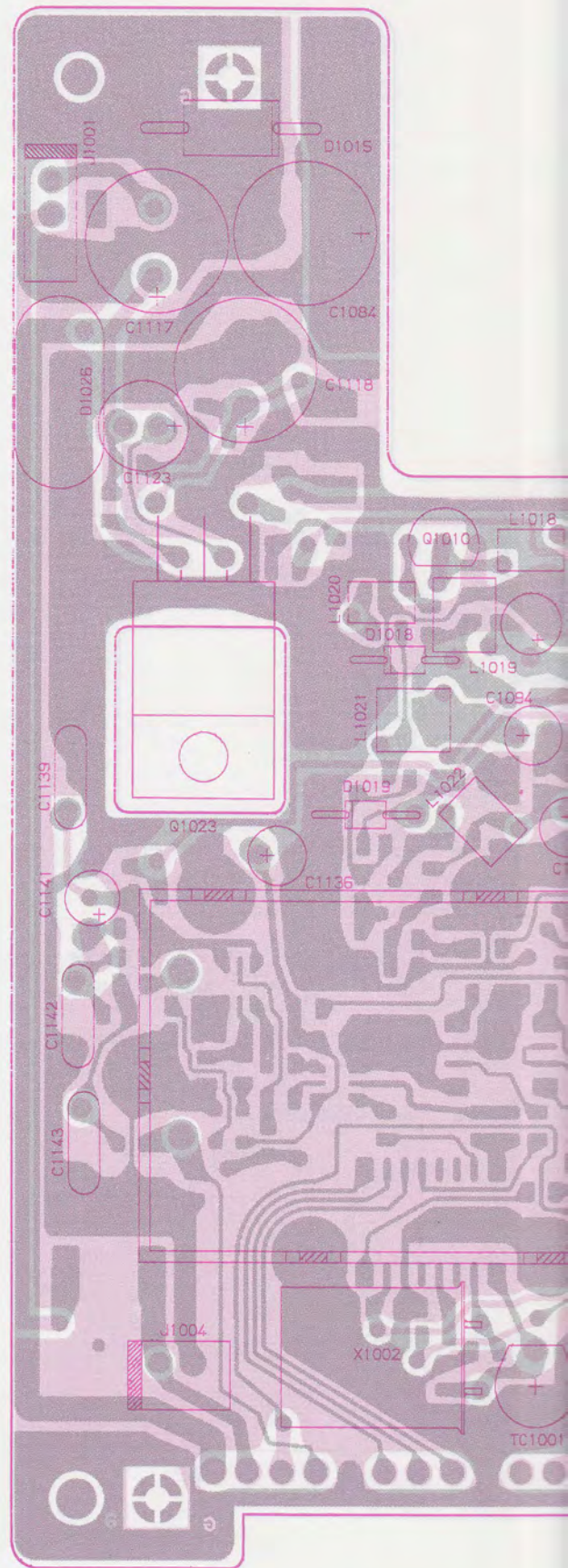



541  
(1013)

Emitter  
Collector

2053  
(1010)

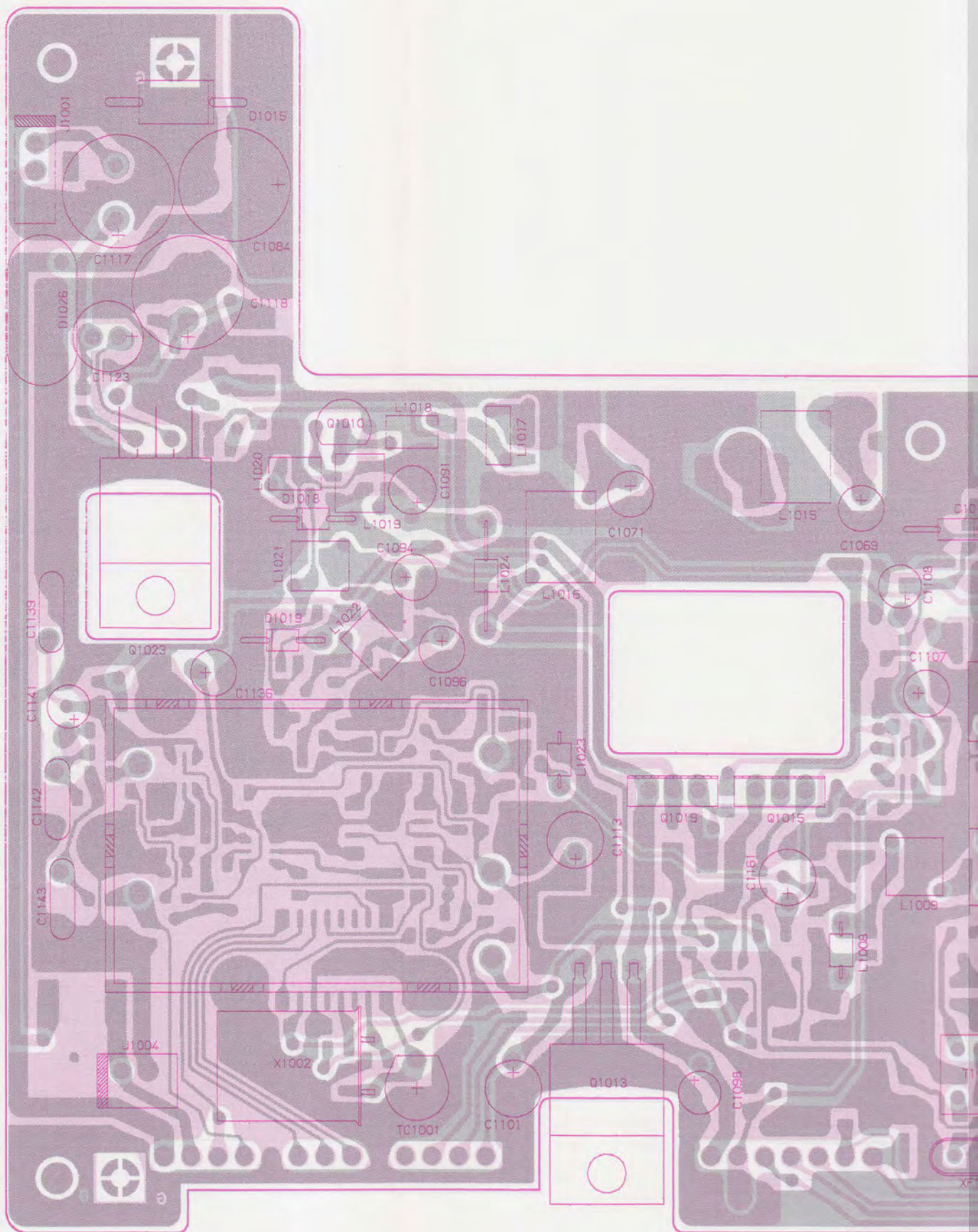

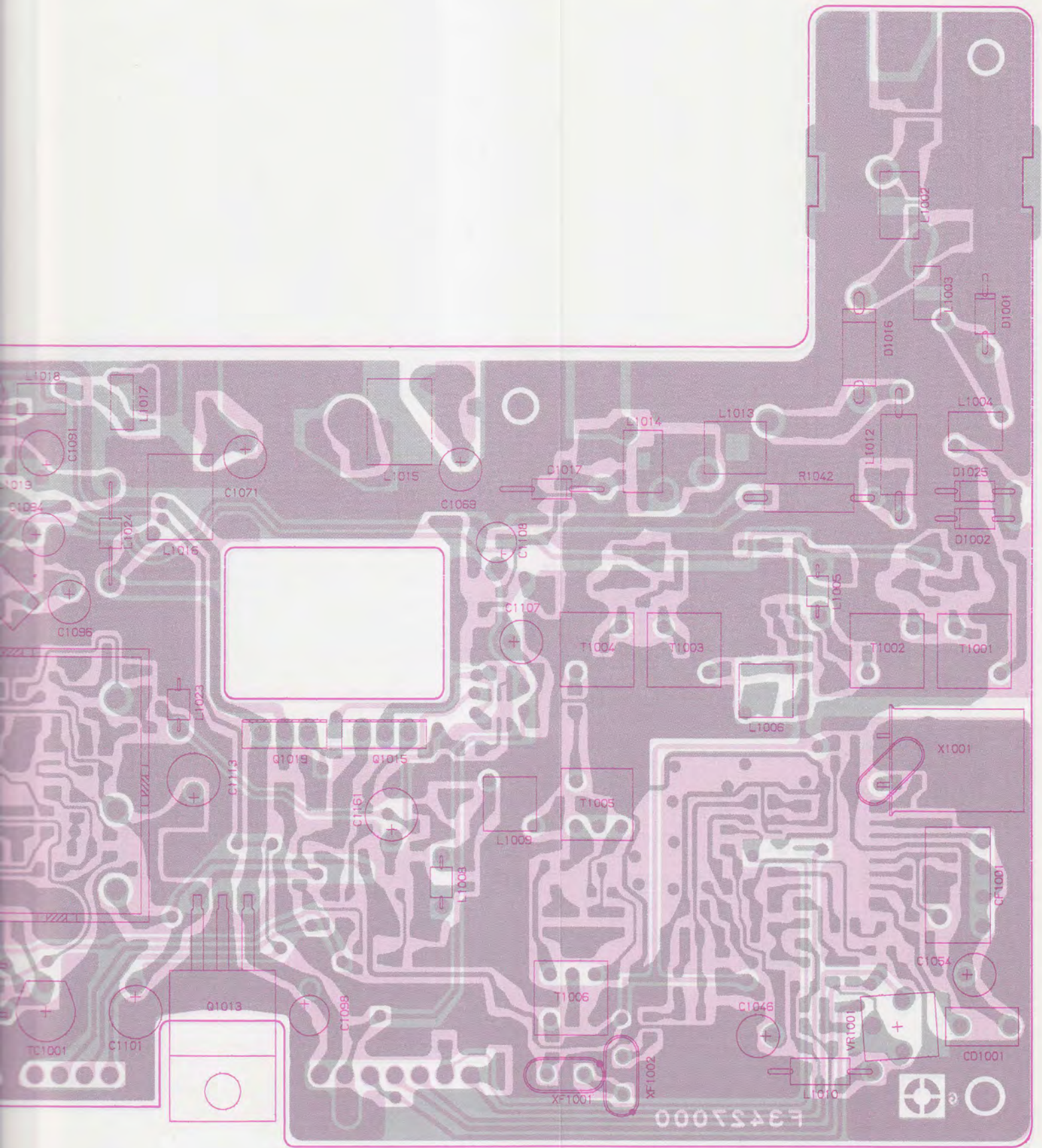

component side

# MAIN Unit

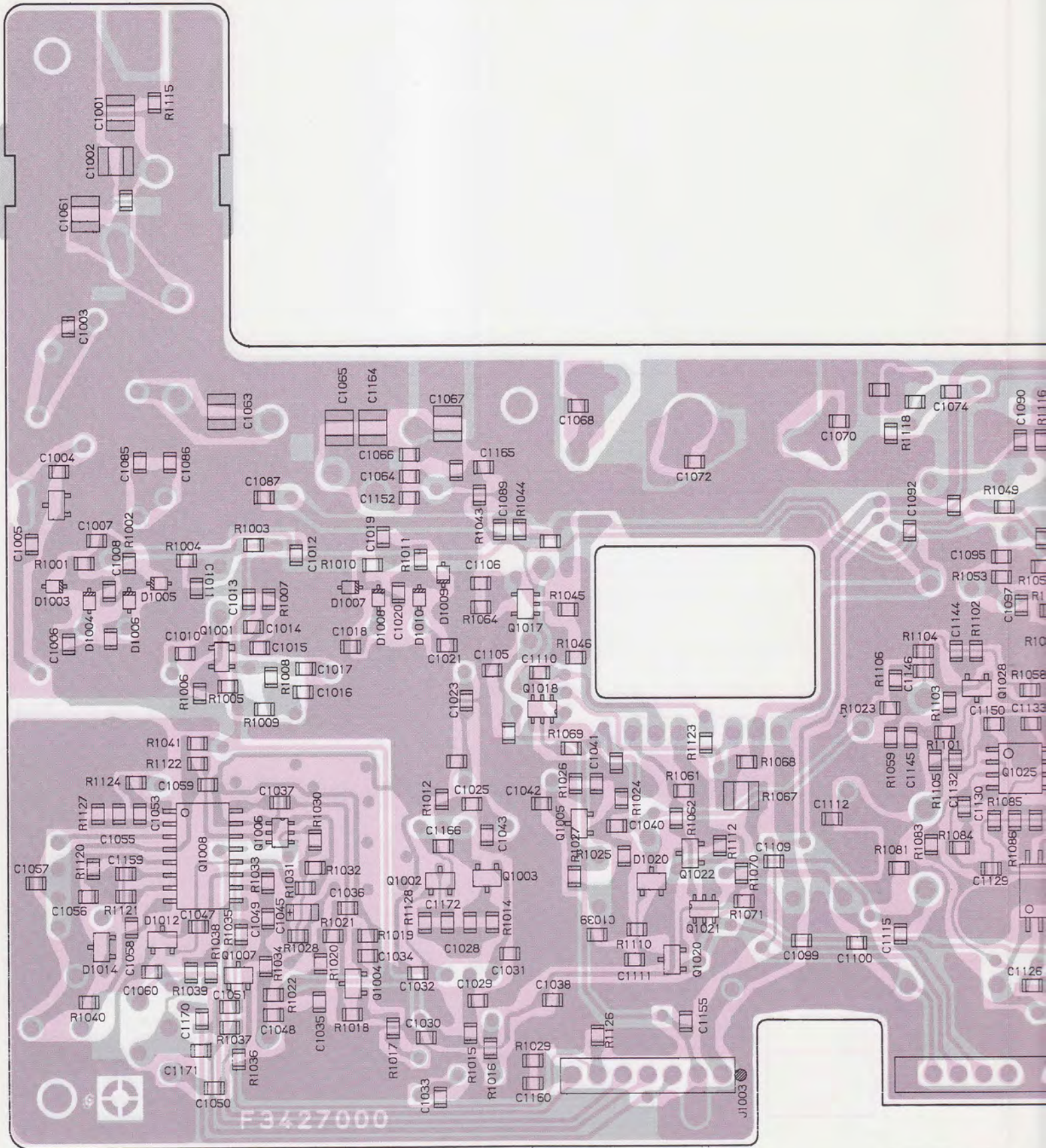

- 7. S-METER
- 6. SCAN STOP
- 5. SOL VOL
- 4. DISC OUT
- 3. NOISE INPUT
- 2. H/M/L
- 1. 13.8V SWED

To CNTL Unit J2007  
(See Page 3D-3)

- 14. GND
- 13. 9V
- 12. AF
- 11. T/R
- 10. NC
- 9. GND

To CNTL Unit J2008  
(See Page 3D-3)





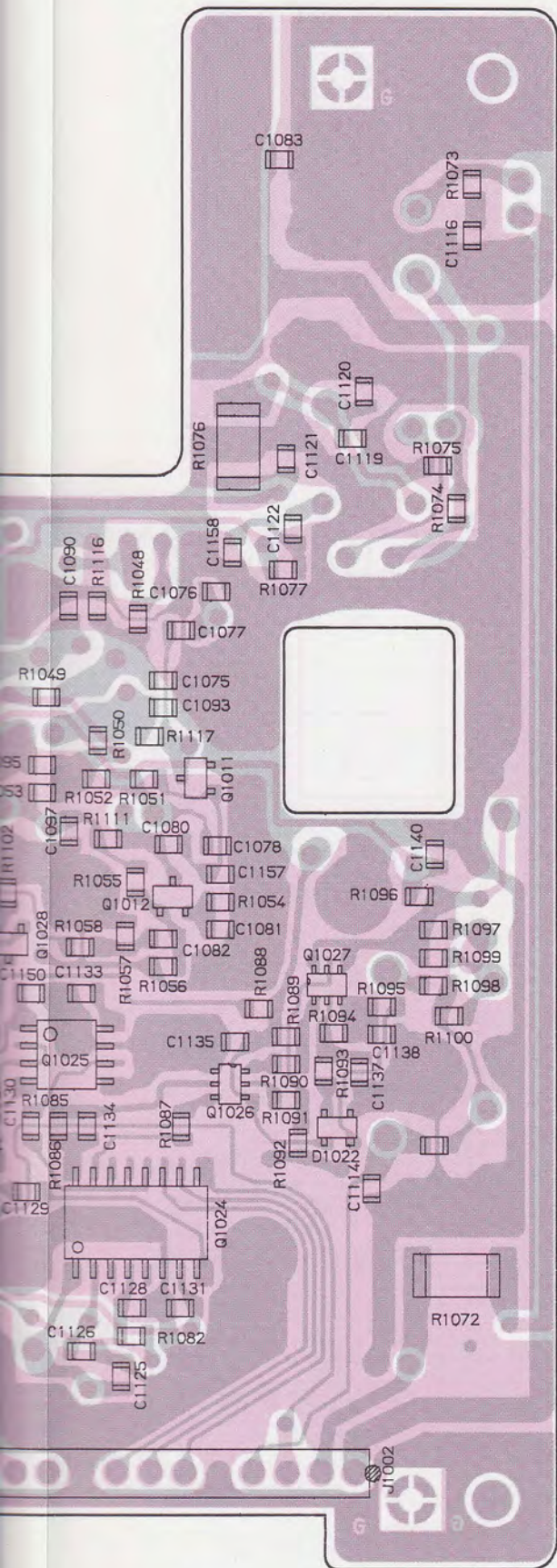

- 11. T/R
- 10. NC
- 9. GND
- 8. PSTB
- 7. DATA
- 6. CLOCK
- 5. GND
- 4. MOD
- 3. 5V
- 2. AF.SP
- 1. 13.8V

chip-only side

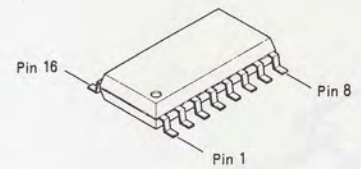

MC3372ML (Q1008)  
MC145158F2L (Q1024)

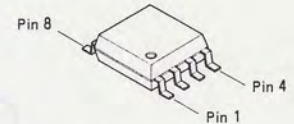

MC12022SLADR2 (Q1025)

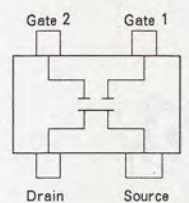

3SK131 (V12) (Q1001)

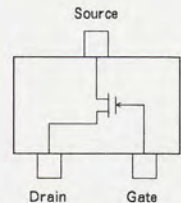

2SK302GR (TG) (Q1002, 1003)

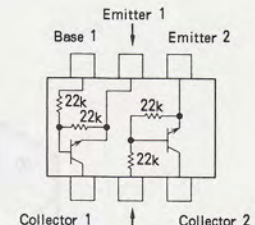

IMH5 (H5) (Q1006, 1021)

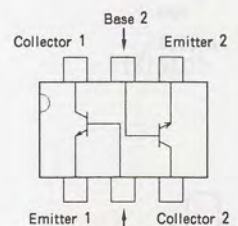

IMX1 (X1) (Q1018)

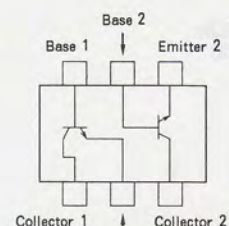

IMX5 (X5) (Q1026)

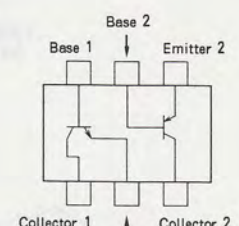

IMZ2 (Z2) (Q1027)

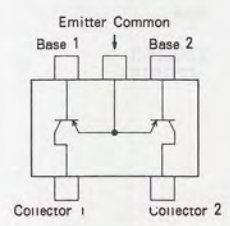

FMS1 (S1) (Q1017)

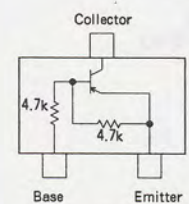

DTA143EK (3C) (Q1020, 1022)

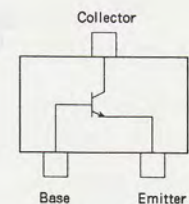

2SC2712GR (LG) (Q1007)  
2SC2714Y (QY) (Q1004, 1028)  
2SC2759 (U22) (Q1005, 1012)  
MMBR951 (7Z) (Q1011)

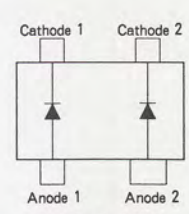

1SS272 (A1) (D1022)

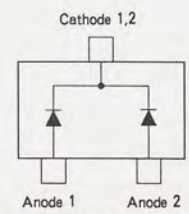

1SS184 (B3) (D1020)

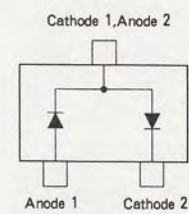

1SS226 (C3) (D1012)

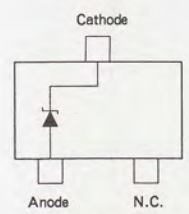

02CZ5.1Y (5.1) (D1014)

# MAIN Unit

REF.	DESCRIPTION	VALUE	WV	TOL.	MFR'S DESIG	YAESU P/N	VERS.
*** MAIN UNIT ***							
	PCB With Components (W/VCO UNIT, W/O IC M67781L)					CP4792001	
	Printed Circuit Board					F3427000	
C 1001	CHIP CAP.	0.001uF	500V	W5R	GRM42-2W5R102K500PT	K22275809	
C 1002	CHIP CAP.	15pF	500V	CH	GRM42-2CH150J500PT	K22275217	
C 1003	CHIP CAP.	27pF	50V	CH	GRM40CH270J50PT	K22170221	
C 1004	CHIP CAP.	10pF	50V	CH	GRM40CH100D50PT	K22170211	
C 1005	CHIP CAP.	0.001uF	50V	B	GRM40B102M50PT	K22170805	
C 1006	CHIP CAP.	3pF	50V	CJ	GRM40CJ030C50PT	K22170204	
C 1007	CHIP CAP.	0.001uF	50V	B	GRM40B102M50PT	K22170805	
C 1008	CHIP CAP.	4pF	50V	CH	GRM40CH040C50PT	K22170205	
C 1010	CHIP CAP.	22pF	50V	CH	GRM40CH220J50PT	K22170219	
C 1011	CHIP CAP.	0.001uF	50V	B	GRM40B102M50PT	K22170805	
C 1012	CHIP CAP.	0.001uF	50V	B	GRM40B102M50PT	K22170805	
C 1013	CHIP CAP.	0.001uF	50V	B	GRM40B102M50PT	K22170805	
C 1014	CHIP CAP.	0.001uF	50V	B	GRM40B102M50PT	K22170805	
C 1015	CHIP CAP.	0.001uF	50V	B	GRM40B102M50PT	K22170805	
C 1016	CHIP CAP.	0.001uF	50V	B	GRM40B102M50PT	K22170805	
C 1017	CHIP CAP.	0.001uF	50V	B	GRM40B102M50PT	K22170805	
C 1018	CHIP CAP.	2pF	50V	CK	GRM40CK020C50PT	K22170203	
C 1019	CHIP CAP.	0.001uF	50V	B	GRM40B102M50PT	K22170805	
C 1020	CHIP CAP.	2pF	50V	CK	GRM40CK020C50PT	K22170203	
C 1021	CHIP CAP.	4pF	50V	CH	GRM40CH040C50PT	K22170205	
C 1023	CHIP CAP.	0.001uF	50V	B	GRM40B102M50PT	K22170805	
C 1025	CHIP CAP.	0.001uF	50V	B	GRM40B102M50PT	K22170805	
C 1028	CHIP CAP.	0.01uF	50V	B	GRM40B103M50PT	K22170817	
C 1029	CHIP CAP.	0.01uF	50V	B	GRM40B103M50PT	K22170817	
C 1030	CHIP CAP.	0.001uF	50V	B	GRM40B102M50PT	K22170805	
C 1031	CHIP CAP.	10pF	50V	CH	GRM40CH100D50PT	K22170211	
C 1032	CHIP CAP.	10pF	50V	CH	GRM40CH100D50PT	K22170211	
C 1033	CHIP CAP.	8pF	50V	CH	GRM40CH080D50PT	K22170209	
C 1034	CHIP CAP.	0.01uF	50V	B	GRM40B103M50PT	K22170817	
C 1035	CHIP CAP.	0.01uF	50V	B	GRM40B103M50PT	K22170817	
C 1036	CHIP CAP.	0.01uF	50V	B	GRM40B103M50PT	K22170817	
C 1037	CHIP CAP.	0.001uF	50V	B	GRM40B102M50PT	K22170805	
C 1038	CHIP CAP.	0.001uF	50V	B	GRM40B102M50PT	K22170805	
C 1039	CHIP CAP.	0.001uF	50V	B	GRM40B102M50PT	K22170805	
C 1040	CHIP CAP.	47pF	50V	CH	GRM40CH470J50PT	K22170227	
C 1041	CHIP CAP.	0.001uF	50V	B	GRM40B102M50PT	K22170805	
C 1042	CHIP CAP.	27pF	50V	CH	GRM40CH270J50PT	K22170221	
C 1043	CHIP CAP.	10pF	50V	CH	GRM40CH100D50PT	K22170211	
C 1045	TANTALUM CHIP CAP.	0.22uF	35V		TESVA1V224M1-8R	K78160027	
C 1046	AL. ELECTRO. CAP.	10uF	16V		16V100M4X7TR2	K46120004	
C 1047	CHIP CAP.	0.1uF	25V	B	GRM40B104M25PT	K22140811	
C 1048	CHIP CAP.	0.01uF	50V	B	GRM40B103M50PT	K22170817	
C 1049	CHIP CAP.	0.01uF	50V	B	GRM40B103M50PT	K22170817	
C 1050	CHIP CAP.	0.0022uF	50V	B	GRM40B222M50PT	K22170809	
C 1051	CHIP CAP.	0.001uF	50V	B	GRM40B102M50PT	K22170805	
C 1053	CHIP CAP.	39pF	50V	CH	GRM40CH390J50PT	K22170225	
C 1054	AL. ELECTRO. CAP.	10uF	16V		16V100M4X7TR2	K46120004	
C 1055	CHIP CAP.	68pF	50V	CH	GRM40CH680J50PT	K22170231	
C 1056	CHIP CAP.	0.1uF	25V	B	GRM40B104M25PT	K22140811	

# MAIN Unit

REF.	DESCRIPTION	VALUE	WV	TOL.	MFGR'S DESIG	YAESU P/N	VERS.
C 1057	CHIP CAP.	0.1uF	25V	B	GRM40B104M25PT	K22140811	
C 1058	CHIP CAP.	82pF	50V	CH	GRM40CH820J50PT	K22170233	
C 1059	CHIP CAP.	0.01uF	50V	B	GRM40B103M50PT	K22170817	
C 1060	CHIP CAP.	0.001uF	50V	B	GRM40B102M50PT	K22170805	
C 1061	CHIP CAP.	33pF	500V	CH	GRM42-2CH330J500PT	K22275225	
C 1063	CHIP CAP.	15pF	500V	CH	GRM42-2CH150J500PT	K22275217	
C 1064	CHIP CAP.	1pF	50V	CK	GRM40CK010C50PT	K22170202	
C 1065	CHIP CAP.	22pF	500V	CH	GRM42-2CH220J500PT	K22275221	
C 1066	CHIP CAP.	7pF	50V	CH	GRM40CH070D50PT	K22170208	
C 1067	CHIP CAP.	10pF	500V	CH	GRM42-2CH100D500PT	K22275213	
C 1068	CHIP CAP.	0.001uF	50V	B	GRM40B102M50PT	K22170805	
C 1069	AL. ELECTRO. CAP.	10uF	16V		16V100M4X7TR2	K46120004	
C 1070	CHIP CAP.	0.001uF	50V	B	GRM40B102M50PT	K22170805	
C 1071	AL. ELECTRO. CAP.	10uF	16V		16V100M4X7TR2	K46120004	
C 1072	CHIP CAP.	0.001uF	50V	B	GRM40B102M50PT	K22170805	
C 1074	CHIP CAP.	12pF	50V	CH	GRM40CH120J50PT	K22170213	
C 1075	CHIP CAP.	0.001uF	50V	B	GRM40B102M50PT	K22170805	
C 1076	CHIP CAP.	33pF	50V	CH	GRM40CH330J50PT	K22170223	
C 1077	CHIP CAP.	12pF	50V	CH	GRM40CH120J50PT	K22170213	
C 1078	CHIP CAP.	0.001uF	50V	B	GRM40B102M50PT	K22170805	
C 1080	CHIP CAP.	47pF	50V	CH	GRM40CH470J50PT	K22170227	
C 1081	CHIP CAP.	100pF	50V	CH	GRM40CH101J50PT	K22170235	
C 1082	CHIP CAP.	22pF	50V	CH	GRM40CH220J50PT	K22170219	
C 1083	CHIP CAP.	0.001uF	50V	B	GRM40B102M50PT	K22170805	
C 1084	AL. ELECTRO. CAP.	1000uF	16V		RE3-16V102MS	K40129067	
C 1085	CHIP CAP.	0.01uF	50V	B	GRM40B103M50PT	K22170817	
C 1086	CHIP CAP.	0.001uF	50V	B	GRM40B102M50PT	K22170805	
C 1087	CHIP CAP.	0.001uF	50V	B	GRM40B102M50PT	K22170805	
C 1089	CHIP CAP.	0.001uF	50V	B	GRM40B102M50PT	K22170805	
C 1090	CHIP CAP.	0.001uF	50V	B	GRM40B102M50PT	K22170805	
C 1091	TANTALUM CAP.	10uF	16V		TPDN1C100M8S	K76120019	
C 1092	CHIP CAP.	0.001uF	50V	B	GRM40B102M50PT	K22170805	
C 1093	CHIP CAP.	0.001uF	50V	B	GRM40B102M50PT	K22170805	
C 1094	AL. ELECTRO. CAP.	10uF	16V		16V100M4X7TR2	K46120004	
C 1095	CHIP CAP.	0.001uF	50V	B	GRM40B102M50PT	K22170805	
C 1096	AL. ELECTRO. CAP.	10uF	16V		16V100M4X7TR2	K46120004	
C 1097	CHIP CAP.	0.001uF	50V	B	GRM40B102M50PT	K22170805	
C 1098	TANTALUM CAP.	0.47uF	35V		TPDN1VR47M8S	K76160019	
C 1099	CHIP CAP.	0.01uF	50V	B	GRM40B103M50PT	K22170817	
C 1100	CHIP CAP.	0.01uF	50V	B	GRM40B103M50PT	K22170817	
C 1101	AL. ELECTRO. CAP.	100uF	10V		10V101M5X11TR5	K46100004	
C 1105	CHIP CAP.	0.01uF	50V	B	GRM40B103M50PT	K22170817	
C 1106	CHIP CAP.	0.01uF	50V	B	GRM40B103M50PT	K22170817	
C 1107	AL. ELECTRO. CAP.	2.2uF	50V		50V2R2M4X7TR2	K46170031	
C 1108	TANTALUM CAP.	1uF	25V		TPDN1E010M8S	K76140013	
C 1109	CHIP CAP.	0.001uF	50V	B	GRM40B102M50PT	K22170805	
C 1110	CHIP CAP.	100pF	50V	CH	GRM40CH101J50PT	K22170235	
C 1111	CHIP CAP.	0.1uF	25V	B	GRM40B104M25PT	K22140811	
C 1112	CHIP CAP.	0.001uF	50V	B	GRM40B102M50PT	K22170805	
C 1113	AL. ELECTRO. CAP.	47uF	16V		RC2-16V470M-T34	K46120010	
C 1114	CHIP CAP.	0.001uF	50V	B	GRM40B102M50PT	K22170805	
C 1115	CHIP CAP.	0.001uF	50V	B	GRM40B102M50PT	K22170805	
C 1116	CHIP CAP.	0.1uF	25V	B	GRM40B104M25PT	K22140811	
C 1117	AL. ELECTRO. CAP.	470uF	16V		RE2-16V471M	K40129049	
C 1118	AL. ELECTRO. CAP.	1000uF	16V		RE3-16V102MS	K40129067	

# MAIN Unit

REF.	DESCRIPTION	VALUE	WV	TOL.	MFGR'S DESIG	YAESU P/N	VERS.
C 1119	CHIP CAP.	0.01uF	50V	B	GRM40B103M50PT	K22170817	
C 1120	CHIP CAP.	0.1uF	25V	B	GRM40B104M25PT	K22140811	
C 1121	CHIP CAP.	0.01uF	50V	B	GRM40B103M50PT	K22170817	
C 1122	CHIP CAP.	0.022uF	50V	B	GRM40B223M50PT	K22170821	
C 1123	AL. ELECTRO. CAP.	47uF	16V		16V470M6X7TR2	K46120006	
C 1125	CHIP CAP.	33pF	50V	CH	GRM40CH330J50PT	K22170223	
C 1126	CHIP CAP.	39pF	50V	CH	GRM40CH390J50PT	K22170225	
C 1128	CHIP CAP.	0.01uF	50V	B	GRM40B103M50PT	K22170817	
C 1129	CHIP CAP.	0.001uF	50V	B	GRM40B102M50PT	K22170805	
C 1130	CHIP CAP.	0.01uF	50V	B	GRM40B103M50PT	K22170817	
C 1131	CHIP CAP.	0.1uF	25V	B	GRM40B104M25PT	K22140811	
C 1132	CHIP CAP.	10pF	50V	CH	GRM40CH100D50PT	K22170211	
C 1133	CHIP CAP.	0.001uF	50V	B	GRM40B102M50PT	K22170805	
C 1134	CHIP CAP.	0.001uF	50V	B	GRM40B102M50PT	K22170805	
C 1135	CHIP CAP.	0.01uF	50V	B	GRM40B103M50PT	K22170817	
C 1136	AL. ELECTRO. CAP.	10uF	16V		16V100M4X7TR2	K46120004	
C 1137	CHIP CAP.	0.1uF	25V	B	GRM40B104M25PT	K22140811	
C 1138	CHIP CAP.	0.1uF	25V	B	GRM40B104M25PT	K22140811	
C 1139	CERAMIC CAP.	0.047uF	25V	X	UAT08X473K-L45AE	K19149021	
C 1140	CHIP CAP.	0.001uF	50V	B	GRM40B102M50PT	K22170805	
C 1141	TANTALUM CAP.	2.2uF	16V		TPDN1C2R2M8S	K76120015	
C 1142	CERAMIC CAP.	0.022uF	25V	X	UAT06X223K-L45AE	K19149017	
C 1143	CERAMIC CAP.	0.015uF	25V	X	UAT06X153K-L45AE	K19149015	
C 1144	CHIP CAP.	0.001uF	50V	B	GRM40B102M50PT	K22170805	
C 1145	CHIP CAP.	0.001uF	50V	B	GRM40B102M50PT	K22170805	
C 1146	CHIP CAP.	22pF	50V	CH	GRM40CH220J50PT	K22170219	
C 1150	CHIP CAP.	33pF	50V	CH	GRM40CH330J50PT	K22170223	
C 1155	CHIP CAP.	0.001uF	50V	B	GRM40B102M50PT	K22170805	
C 1157	CHIP CAP.	18pF	50V	CH	GRM40CH180J50PT	K22170217	
C 1158	CHIP CAP.	0.033uF	25V	B	GRM40B333M25PT	K22140810	
C 1159	CHIP CAP.	0.1uF	25V	B	GRM40B104M25PT	K22140811	
C 1160	CHIP CAP.	0.1uF	25V	B	GRM40B104M25PT	K22140811	
C 1161	AL. ELECTRO. CAP.	0.47uF	50V		50VR47M5X11TR5	K46170016	
C 1164	CHIP CAP.	4pF	500V	CH	GRM42-2CH040C500PT	K22275207	
C 1165	CHIP CAP.	12pF	50V	CH	GRM40CH120J50PT	K22170213	
C 1166	CHIP CAP.	3pF	50V	CJ	GRM40CJ030C50PT	K22170204	
C 1170	CHIP CAP.	68pF	50V	CH	GRM40CH680J50PT	K22170231	
C 1171	CHIP CAP.	0.001uF	50V	B	GRM40B102M50PT	K22170805	
C 1172	CHIP CAP.	0.01uF	50V	B	GRM40B103M50PT	K22170817	
CD1001	CERAMIC DISC				CDB455C7	H7900180	
CF1001	CERAMIC FILTER				CFW455E	H3900200	
D 1001	DIODE				MI308	G2090337	
D 1002	DIODE				MI301	G2090033	
D 1003	DIODE				1SV214 TPH	G2070356	
D 1004	DIODE				1SV214 TPH	G2070356	
D 1005	DIODE				1SV214 TPH	G2070356	
D 1006	DIODE				1SV214 TPH	G2070356	
D 1007	DIODE				1SV214 TPH	G2070356	
D 1008	DIODE				1SV214 TPH	G2070356	
D 1009	DIODE				1SV214 TPH	G2070356	
D 1010	DIODE				1SV214 TPH	G2070356	
D 1012	DIODE				1SS226 TE85R	G2070003	

# MAIN Unit

REF.	DESCRIPTION	VALUE	WV	TOL.	MFGR'S DESIG	YAESU P/N	VERS.
D 1014	DIODE				02CZ5.1Y TE85R	G2070062	
D 1015	SURGE ABSORBER				P6KE18	Q9000534	
D 1016	DIODE				UM9415	G2090425	
D 1017	DIODE				1SS97	G2090118	
D 1018	DIODE				1SS270TJ	G2060004	
D 1019	DIODE				1SS270TJ	G2060004	
D 1020	DIODE				1SS184 TE85R	G2070009	
D 1022	DIODE				1SS272 TE85R	G2070048	
D 1025	DIODE				MI308	G2090337	
J 1001	CONNECTOR				B3B-EH	P0090667	
J 1002	CONNECTOR				IMSA-1068-14Z040	P0090787	
J 1003	CONNECTOR				IMSA-1068-07Z040	P0090833	
J 1004	CONNECTOR				SC25-02WS	P0090621	
L 1002	COIL				2.5T5.5D1.2UEW R	L0022129	
L 1003	COIL				1.5T3.5D0.6UEW R	L0021359A	
L 1004	COIL				3.5T3.5D0.6UEW R	L0021818A	
L 1005	M. RFC	0.33uH			LAL02KRR33K	L1190354	
L 1006	COIL				5.5T3.5D0.6UEW R	L0021705A	
L 1008	M. RFC	0.47uH			LAL02KRR47M	L1190352	
L 1009	COIL				5.5T3.5D0.6UEW R	L0021705A	
L 1010	M. RFC	1mH			LAL03KH102K	L1190390	
L 1012	M. RFC	4.7uH			LAL04NA4R7K	L1190095	
L 1013	COIL				3.5T5.0D1.2UEW R	L0022130	
L 1014	COIL				2.5T5.0D1.2UEW R	L0022131	
L 1015	COIL				8.5T4.0D0.8UEW R	L0020751A	
L 1016	COIL				8.5T4.0D0.8UEW R	L0020751A	
L 1018	COIL				1.5T3.5D0.6UEW R	L0021359A	
L 1019	COIL				4.5T3.5D0.6UEW R	L0020679A	
L 1020	COIL				2.5T3.0D0.6UEW R	L0021811A	
L 1021	COIL				4.5T3.5D0.6UEW R	L0020679A	
L 1022	COIL				3.5T3.5D0.6UEW R	L0021818A	
L 1023	M. RFC	0.22uH			LAL02KRR22M	L1190342	
L 1024	M. RFC	0.22uH			LAL02NAR22M	L1190275	
Q 1001	FET				3SK131-T2B V12	G4801317B	
Q 1002	FET				2SK302GR TE85R	G3803027G	
Q 1003	FET				2SK302GR TE85R	G3803027G	
Q 1004	TRANSISTOR				2SC2714YTE85R	G3327147Y	
Q 1005	TRANSISTOR				2SC2759-T2B U22	G3327597B	
Q 1006	TRANSISTOR				1MH5 T108	G3070027	
Q 1007	TRANSISTOR				2SC2712GR TE85R	G3327127G	
Q 1008	IC				MC3372ML	G1091108	
Q 1009	IC				M67781L	G1091642	
Q 1010	TRANSISTOR				2SC2053	G3320530	
Q 1011	TRANSISTOR				MMBR951LT1	G3070056	
Q 1012	TRANSISTOR				2SC2759-T2B U22	G3327597B	
Q 1013	IC				AN6541	G1091146	
Q 1015	TRANSISTOR				2SB1143S	G3211430S	
Q 1017	TRANSISTOR				FMS1 T148	G3070008	
Q 1018	TRANSISTOR				IMX1 T110	G3070024	
Q 1019	TRANSISTOR				2SB1143S	G3211430S	
Q 1020	TRANSISTOR				DTA143EK T146	G3070010	
Q 1021	TRANSISTOR				1MH5 T108	G3070027	

# MAIN Unit

REF.	DESCRIPTION	VALUE	WV	TOL.	MFR'S DESIG	YAESU P/N	VERS.
Q 1022	TRANSISTOR				DTA143EK T146	G3070010	
Q 1023	IC				TDA2003H	G1090815	
Q 1024	IC				MC145158F2L	G1091105	
Q 1025	IC				MC12022SLADR2	G1091103	
Q 1026	TRANSISTOR				IMX5 T108	G3070028	
Q 1027	TRANSISTOR				IMZ2 T108	G3070060	
Q 1028	TRANSISTOR				2SC2714YTE85R	G3327147Y	
R 1001	CHIP RES.	2.2M	1/10W	5%	RMC1/10T 225J	J24205225	
R 1002	CHIP RES.	2.2M	1/10W	5%	RMC1/10T 225J	J24205225	
R 1003	CHIP RES.	150K	1/10W	5%	RMC1/10T 154J	J24205154	
R 1004	CHIP RES.	22K	1/10W	5%	RMC1/10T 223J	J24205223	
R 1005	CHIP RES.	18K	1/10W	5%	RMC1/10T 183J	J24205183	
R 1006	CHIP RES.	22K	1/10W	5%	RMC1/10T 223J	J24205223	
R 1007	CHIP RES.	47	1/10W	5%	RMC1/10T 470J	J24205470	
R 1008	CHIP RES.	470	1/10W	5%	RMC1/10T 471J	J24205471	
R 1009	CHIP RES.	100	1/10W	5%	RMC1/10T 101J	J24205101	
R 1010	CHIP RES.	2.2M	1/10W	5%	RMC1/10T 225J	J24205225	
R 1011	CHIP RES.	2.2M	1/10W	5%	RMC1/10T 225J	J24205225	
R 1012	CHIP RES.	47	1/10W	5%	RMC1/10T 470J	J24205470	
R 1014	CHIP RES.	1K	1/10W	5%	RMC1/10T 102J	J24205102	
R 1015	CHIP RES.	10	1/10W	5%	RMC1/10T 100J	J24205100	
R 1016	CHIP RES.	0	1/10W	5%	RMC1/10T 000J	J24205000	
R 1017	CHIP RES.	820	1/10W	5%	RMC1/10T 821J	J24205821	
R 1018	CHIP RES.	100K	1/10W	5%	RMC1/10T 104J	J24205104	
R 1019	CHIP RES.	220	1/10W	5%	RMC1/10T 221J	J24205221	
R 1020	CHIP RES.	220	1/10W	5%	RMC1/10T 221J	J24205221	
R 1021	CHIP RES.	1K	1/10W	5%	RMC1/10T 102J	J24205102	
R 1022	CHIP RES.	100	1/10W	5%	RMC1/10T 101J	J24205101	
R 1023	CHIP RES.	15	1/10W	5%	RMC1/10T 150J	J24205150	
R 1024	CHIP RES.	1K	1/10W	5%	RMC1/10T 102J	J24205102	
R 1025	CHIP RES.	4.7K	1/10W	5%	RMC1/10T 472J	J24205472	
R 1026	CHIP RES.	27	1/10W	5%	RMC1/10T 270J	J24205270	
R 1027	CHIP RES.	470	1/10W	5%	RMC1/10T 471J	J24205471	
R 1028	CHIP RES.	100K	1/10W	5%	RMC1/10T 104J	J24205104	
R 1030	CHIP RES.	4.7K	1/10W	5%	RMC1/10T 472J	J24205472	
R 1031	CHIP RES.	470K	1/10W	5%	RMC1/10T 474J	J24205474	
R 1032	CHIP RES.	820K	1/10W	5%	RMC1/10T 824J	J24205824	
R 1033	CHIP RES.	470K	1/10W	5%	RMC1/10T 474J	J24205474	
R 1034	CHIP RES.	4.7K	1/10W	5%	RMC1/10T 472J	J24205472	
R 1035	CHIP RES.	390K	1/10W	5%	RMC1/10T 394J	J24205394	
R 1036	CHIP RES.	4.7K	1/10W	5%	RMC1/10T 472J	J24205472	
R 1037	CHIP RES.	10K	1/10W	5%	RMC1/10T 103J	J24205103	
R 1038	CHIP RES.	4.7K	1/10W	5%	RMC1/10T 472J	J24205472	
R 1039	CHIP RES.	8.2K	1/10W	5%	RMC1/10T 822J	J24205822	
R 1040	CHIP RES.	1.8K	1/10W	5%	RMC1/10T 182J	J24205182	
R 1041	CHIP RES.	220	1/10W	5%	RMC1/10T 221J	J24205221	
R 1042	METAL FILM RES.	82	1W	5%	ERG-1SJ820P	J22309029	
R 1043	CHIP RES.	1K	1/10W	5%	RMC1/10T 102J	J24205102	
R 1044	CHIP RES.	10K	1/10W	5%	RMC1/10T 103J	J24205103	
R 1045	CHIP RES.	1K	1/10W	5%	RMC1/10T 102J	J24205102	
R 1046	CHIP RES.	3.3K	1/10W	5%	RMC1/10T 332J	J24205332	
R 1048	CHIP RES.	330	1/10W	5%	RMC1/10T 331J	J24205331	
R 1049	CHIP RES.	1.2K	1/10W	5%	RMC1/10T 122J	J24205122	
R 1050	CHIP RES.	100	1/10W	5%	RMC1/10T 101J	J24205101	

# MAIN Unit

REF.	DESCRIPTION	VALUE	WV	TOL.	MFGR'S DESIG	YAESU P/N	VERS.
R 1051	CHIP RES.	220	1/10W	5%	RMC1/10T 221J	J24205221	
R 1052	CHIP RES.	2. 2K	1/10W	5%	RMC1/10T 222J	J24205222	
R 1053	CHIP RES.	470	1/10W	5%	RMC1/10T 471J	J24205471	
R 1054	CHIP RES.	56	1/10W	5%	RMC1/10T 560J	J24205560	
R 1055	CHIP RES.	4. 7K	1/10W	5%	RMC1/10T 472J	J24205472	
R 1056	CHIP RES.	1K	1/10W	5%	RMC1/10T 102J	J24205102	
R 1057	CHIP RES.	220	1/10W	5%	RMC1/10T 221J	J24205221	
R 1058	CHIP RES.	100	1/10W	5%	RMC1/10T 101J	J24205101	
R 1059	CHIP RES.	220	1/10W	5%	RMC1/10T 221J	J24205221	
R 1061	CHIP RES.	22K	1/10W	5%	RMC1/10T 223J	J24205223	
R 1062	CHIP RES.	2. 2K	1/10W	5%	RMC1/10T 222J	J24205222	
R 1064	CHIP RES.	100K	1/10W	5%	RMC1/10T 104J	J24205104	
R 1067	CHIP RES.	330	1/4W	5%	RMC1/4 331JATP	J24245331	
R 1068	CHIP RES.	2. 2K	1/10W	5%	RMC1/10T 222J	J24205222	
R 1069	CHIP RES.	22K	1/10W	5%	RMC1/10T 223J	J24205223	
R 1070	CHIP RES.	1. 8K	1/10W	5%	RMC1/10T 182J	J24205182	
R 1071	CHIP RES.	1. 5K	1/10W	5%	RMC1/10T 152J	J24205152	
R 1072	CHIP RES.	2. 2	1W	5%	RMC1 2R2JTE	J24305229	
R 1073	CHIP RES.	1	1/10W	5%	RMC1/10T 1R0J	J24205010	
R 1074	CHIP RES.	560	1/10W	5%	RMC1/10T 561J	J24205561	
R 1075	CHIP RES.	10	1/10W	5%	RMC1/10T 100J	J24205100	
R 1076	CHIP RES.	1	1W	5%	RMC1 1R0JTE	J24305010	
R 1077	CHIP RES.	10K	1/10W	5%	RMC1/10T 103J	J24205103	
R 1082	CHIP RES.	47	1/10W	5%	RMC1/10T 470J	J24205470	
R 1083	CHIP RES.	47	1/10W	5%	RMC1/10T 470J	J24205470	
R 1084	CHIP RES.	4. 7K	1/10W	5%	RMC1/10T 472J	J24205472	
R 1085	CHIP RES.	10K	1/10W	5%	RMC1/10T 103J	J24205103	
R 1086	CHIP RES.	15K	1/10W	5%	RMC1/10T 153J	J24205153	
R 1087	CHIP RES.	4. 7K	1/10W	5%	RMC1/10T 472J	J24205472	
R 1088	CHIP RES.	10	1/10W	5%	RMC1/10T 100J	J24205100	
R 1089	CHIP RES.	220	1/10W	5%	RMC1/10T 221J	J24205221	
R 1090	CHIP RES.	1K	1/10W	5%	RMC1/10T 102J	J24205102	
R 1091	CHIP RES.	560	1/10W	5%	RMC1/10T 561J	J24205561	
R 1092	CHIP RES.	560	1/10W	5%	RMC1/10T 561J	J24205561	
R 1093	CHIP RES.	560	1/10W	5%	RMC1/10T 561J	J24205561	
R 1094	CHIP RES.	4. 7K	1/10W	5%	RMC1/10T 472J	J24205472	
R 1095	CHIP RES.	560	1/10W	5%	RMC1/10T 561J	J24205561	
R 1096	CHIP RES.	2. 2M	1/10W	5%	RMC1/10T 225J	J24205225	
R 1097	CHIP RES.	1K	1/10W	5%	RMC1/10T 102J	J24205102	
R 1098	CHIP RES.	56	1/10W	5%	RMC1/10T 560J	J24205560	
R 1099	CHIP RES.	8. 2K	1/10W	5%	RMC1/10T 822J	J24205822	
R 1100	CHIP RES.	8. 2K	1/10W	5%	RMC1/10T 822J	J24205822	
R 1101	CHIP RES.	470	1/10W	5%	RMC1/10T 471J	J24205471	
R 1102	CHIP RES.	100	1/10W	5%	RMC1/10T 101J	J24205101	
R 1103	CHIP RES.	10K	1/10W	5%	RMC1/10T 103J	J24205103	
R 1104	CHIP RES.	2. 2K	1/10W	5%	RMC1/10T 222J	J24205222	
R 1105	CHIP RES.	100	1/10W	5%	RMC1/10T 101J	J24205101	
R 1106	CHIP RES.	15	1/10W	5%	RMC1/10T 150J	J24205150	
R 1110	CHIP RES.	47	1/10W	5%	RMC1/10T 470J	J24205470	
R 1111	CHIP RES.	150	1/10W	5%	RMC1/10T 151J	J24205151	
R 1112	CHIP RES.	1K	1/10W	5%	RMC1/10T 102J	J24205102	
R 1115	CHIP RES.	22K	1/10W	5%	RMC1/10T 223J	J24205223	
R 1117	CHIP RES.	100	1/10W	5%	RMC1/10T 101J	J24205101	
R 1118	CHIP RES.	680	1/10W	5%	RMC1/10T 681J	J24205681	
R 1120	CHIP RES.	1. 8K	1/10W	5%	RMC1/10T 182J	J24205182	

# MAIN Unit

REF.	DESCRIPTION	VALUE	WV	TOL.	MFGR'S DESIG	YAESU P/N	VERS.
R 1121	CHIP RES.	47K	1/10W	5%	RMC1/10T 473J	J24205473	
R 1122	CHIP RES.	22K	1/10W	5%	RMC1/10T 223J	J24205223	
R 1123	CHIP RES.	0	1/10W	5%	RMC1/10T 000J	J24205000	
R 1124	CHIP RES.	47	1/10W	5%	RMC1/10T 470J	J24205470	
R 1126	CHIP RES.	10K	1/10W	5%	RMC1/10T 103J	J24205103	
R 1128	CHIP RES.	1K	1/10W	5%	RMC1/10T 102J	J24205102	
R 1129	CHIP RES.	6.8	1/10W	5%	RMC1/10T 6R8J	J24205689	
R 1130	CHIP RES.	680	1/10W	5%	RMC1/10T 681J	J24205681	
T 1001	COIL				160M R12-K905X	L0022053	
T 1002	COIL				160M R12-K907X	L0022055	
T 1003	COIL				160M R12-K908X	L0022054	
T 1004	COIL				160M R12-K906X	L0022056	
T 1005	COIL				456DB-1007	L0190173	
T 1006	COIL				21.4M	L0022111	
TC1001	TRIMMER CAP.	20pF			TZ03R200ER	K91000071	
VR1001	POT.	50K			EVN-DXAA03B54	J51783503	
X 1001	XTAL	21.855MHz				H0103015	
X 1002	XTAL	12.800MHz				H0102801	
XF1001	XTAL				21M15BU	H1102095	
	SHIELD CASE					R0135790A	
	LEAF SPRING					R0137160	
	XTAL HOLDER (2pcs)					R3129530	



# Notes

REF.	DESCRIPTION	VALUE	UNIT	QTY	REF'S DESIGN	YRSU P/N	VER.
R 1131	CHIP RES.	47K	1/10W 5%		RMC1\10T 4731	J34205473	
R 1132	CHIP RES.	33K	1/10W 5%		RMC1\10T 3331	J34205823	
R 1133	CHIP RES.	0	1/10W 5%		RMC1\10T 0001	J34205000	
R 1134	CHIP RES.	47	1/10W 5%		RMC1\10T 4701	J34205470	
R 1136	CHIP RES.	10K	1/10W 5%		RMC1\10T 1031	J34205103	
R 1138	CHIP RES.	1K	1/10W 5%		RMC1\10T 1031	J34205103	
R 1139	CHIP RES.	6.8	1/10W 5%		RMC1\10T 6811	J34205889	
R 1130	CHIP RES.	680	1/10W 5%		RMC1\10T 6811	J34205881	
T 1001	COIL				1GM R13-K302X	L0033053	
T 1002	COIL				1GM R13-K307X	L0033055	
T 1003	COIL				1GM R13-K308X	L0033054	
T 1004	COIL				1GM R13-K308X	L0033056	
T 1005	COIL				4500-100T	L0190113	
T 1006	COIL				21.4M	L0033111	
TC1001	TRIMMER CAP.	30%			T3038200R	K21000071	
VR1001	POT.	50K			50K-DRA03854	J81783603	
X 1001	XTAL	21.855MHz				H0103015	
X 1002	XTAL	12.800MHz				H0102801	
XP1001	XTAL				MINISBU	H1102085	
	XTAL HOLDER (3pcs)					R0132780A	
	SHIELD CASE					R0137180	
	LEAF SPRING					R3128530	

To DISPLAY Unit JP3001  
(See Page 3E-3)

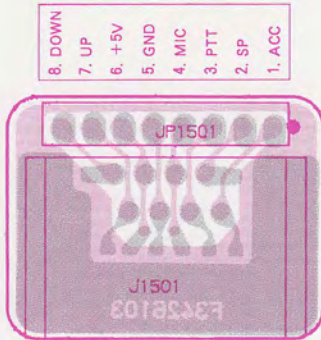

connector side

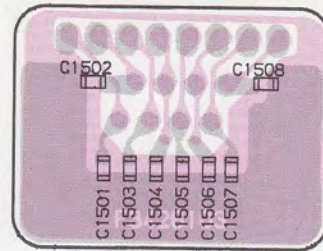

chip-only side

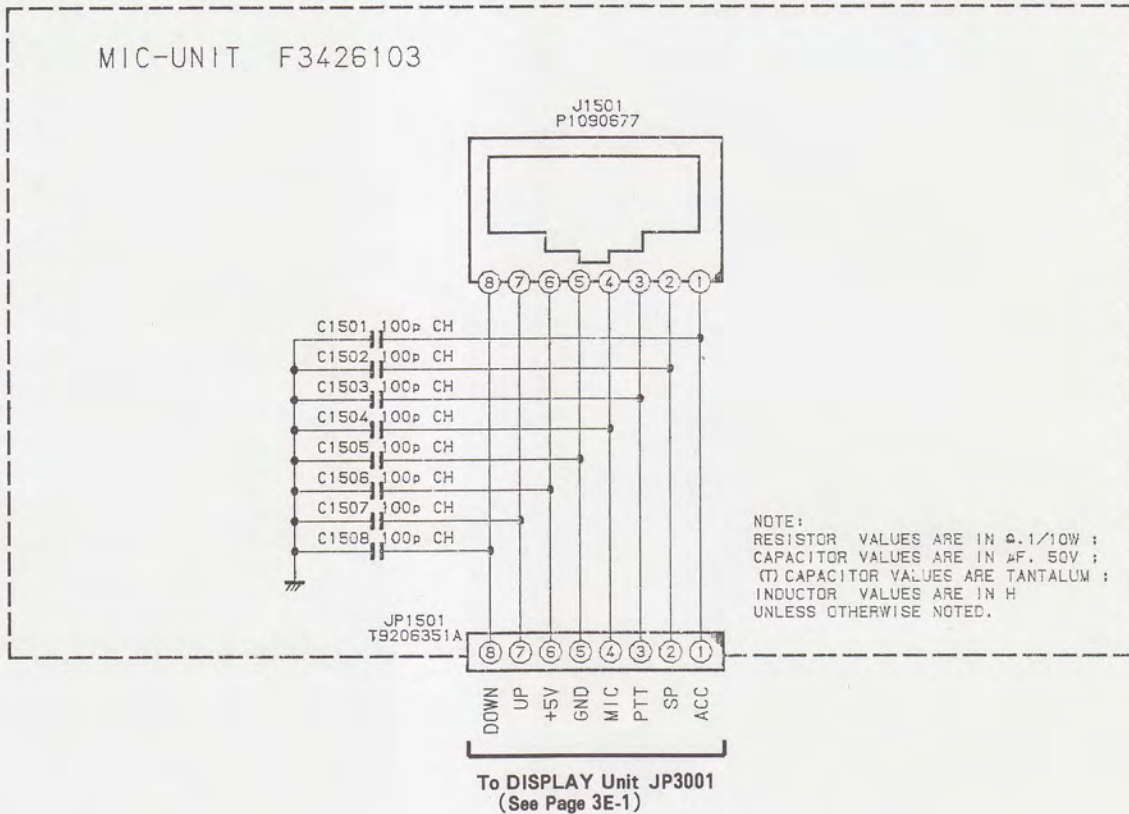

REF.	DESCRIPTION	VALUE	WV	TOL.	MFGR'S DESIG	YAESU P/N	VERS.
------	-------------	-------	----	------	--------------	-----------	-------

\*\*\* MIC UNIT \*\*\*

	PCB With Components (W/O WIRE ASSY)					CS1368001	
	Printed Circuit Board					F3426103	
C 1501	CHIP CAP.	100pF	50V	CH	GRM39CH101J50PT	K22174235	
C 1502	CHIP CAP.	100pF	50V	CH	GRM39CH101J50PT	K22174235	
C 1503	CHIP CAP.	100pF	50V	CH	GRM39CH101J50PT	K22174235	
C 1504	CHIP CAP.	100pF	50V	CH	GRM39CH101J50PT	K22174235	
C 1505	CHIP CAP.	100pF	50V	CH	GRM39CH101J50PT	K22174235	
C 1506	CHIP CAP.	100pF	50V	CH	GRM39CH101J50PT	K22174235	
C 1507	CHIP CAP.	100pF	50V	CH	GRM39CH101J50PT	K22174235	
C 1508	CHIP CAP.	100pF	50V	CH	GRM39CH101J50PT	K22174235	
J 1501	CONNECTOR				R41-2736H	P1090677	
JP1501	WIRE ASSY					T9206351	

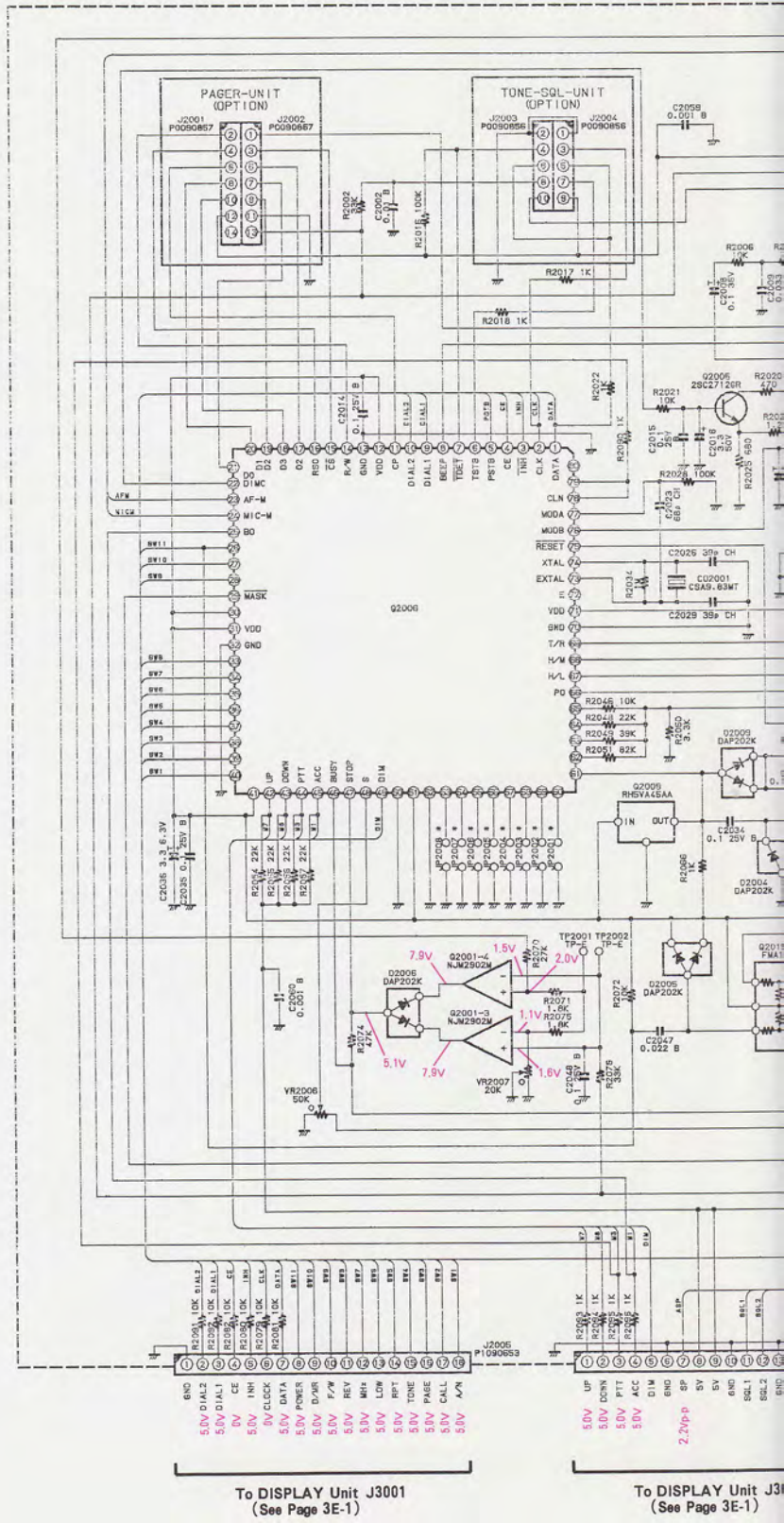
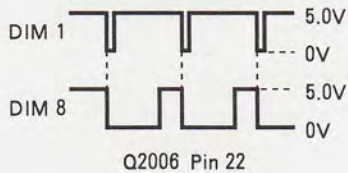
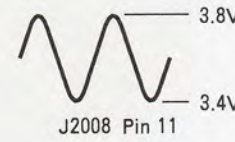
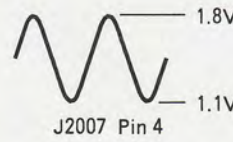
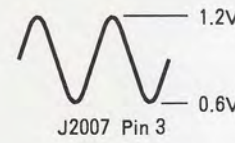
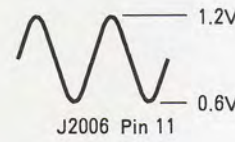
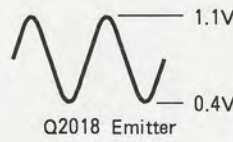
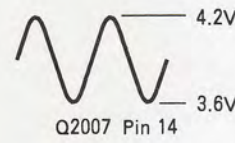
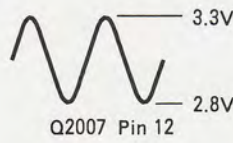
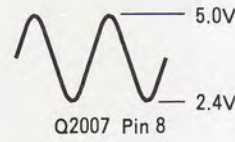
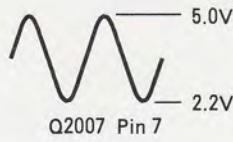
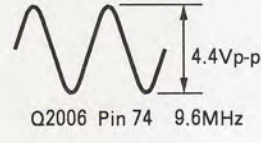
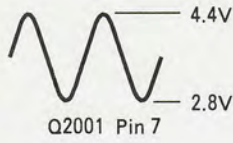
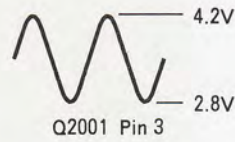
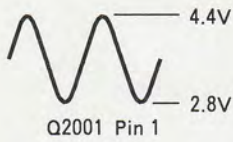

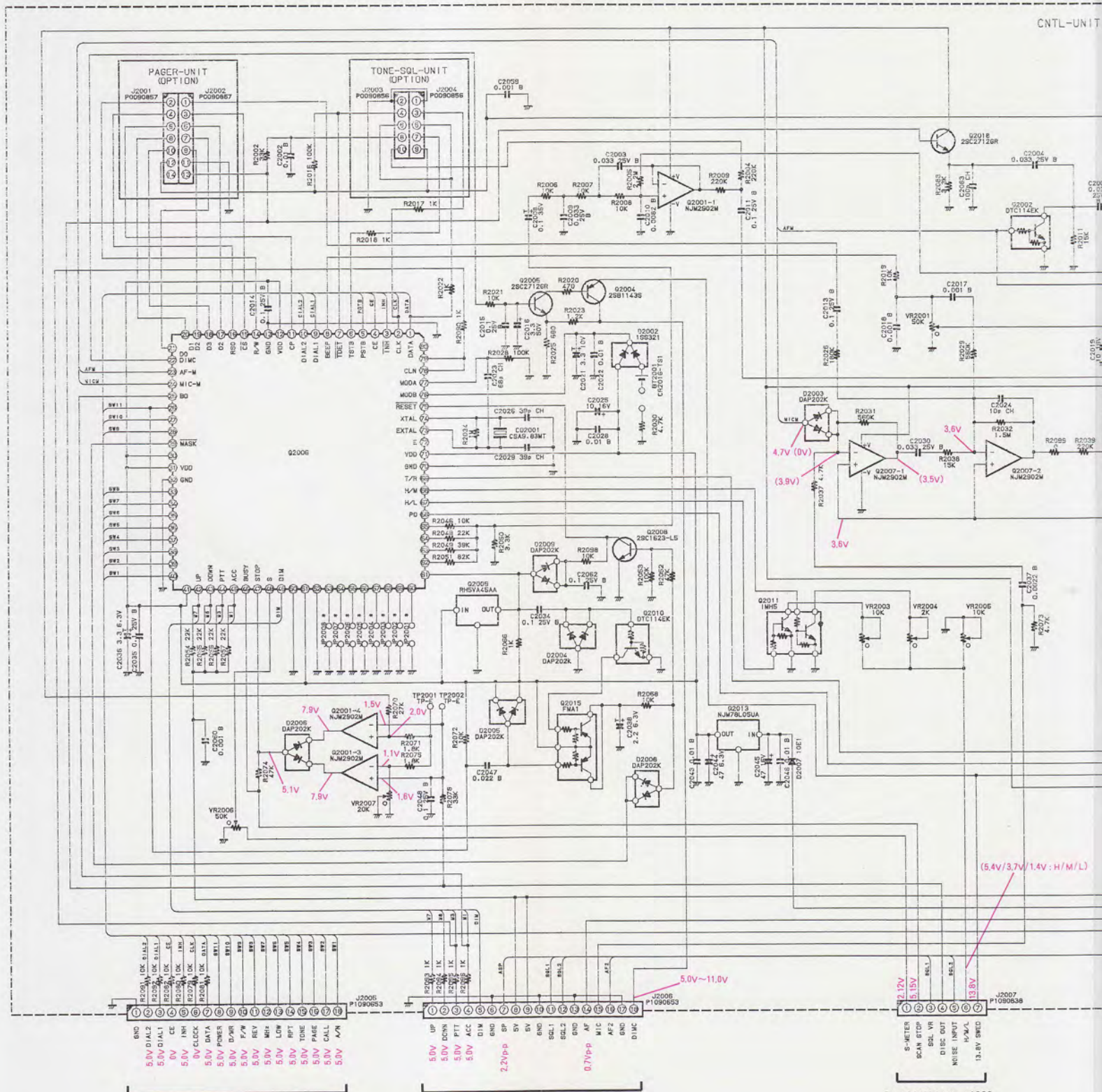

To DISPLAY Unit J3001  
(See Page 3E-1)

To DISPLAY Unit J3002  
(See Page 3E-1)

To MAIN Unit J1003  
(See Page 3B-1)

- 5.0V DIAL2
- 5.0V DIAL1
- 5.0V CE
- 5.0V NH
- 5.0V CLOCK
- 5.0V DATA
- 5.0V POWER
- 5.0V D/AR
- 5.0V REV
- 5.0V MB
- 5.0V LOW
- 5.0V RPT
- 5.0V TONE
- 5.0V PAUSE
- 5.0V CALL
- 5.0V A/V

- 5.0V DOWN
- 5.0V PTT
- 5.0V ACC
- 5.0V DIM
- 2.2Vp-p
- 0.7Vp-p
- 5.0V-11.0V

- 2.12V
- 5.15V
- 13.8V
- 13.8V SWED

CNTL-UNIT F3426101

NOTE:  
RESISTOR VALUES ARE IN Ω, 1/10Ω ;  
CAPACITOR VALUES ARE IN μF, 50V ;  
C) CAPACITOR VALUES ARE TANTALUM ;  
INDUCTOR VALUES ARE IN H  
UNLESS OTHERWISE NOTED.

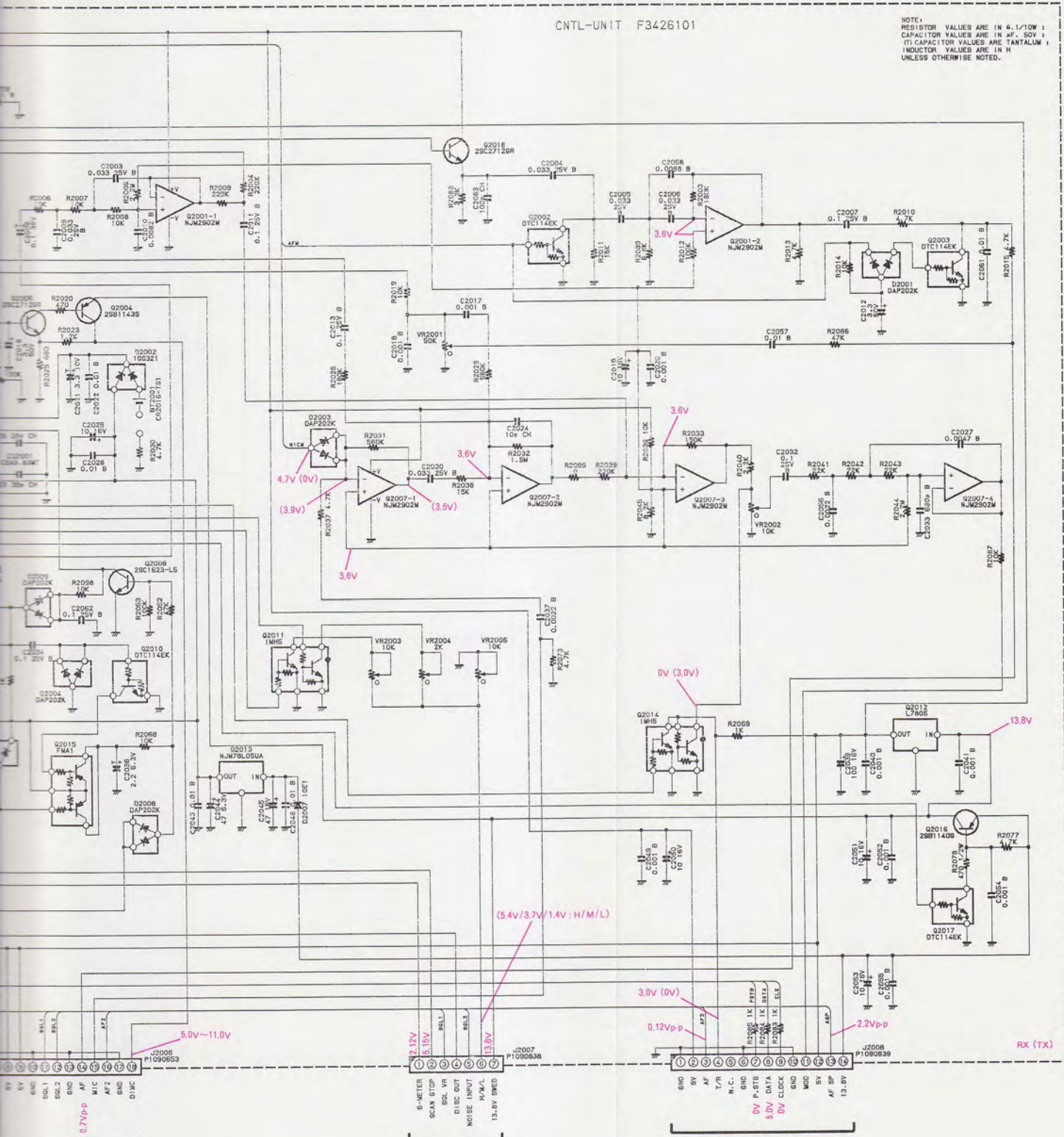

LAY Unit J3002  
Page 3E-1)

To MAIN Unit J1003  
(See Page 3B-1)

To MAIN Unit J1002  
(See Page 3B-1)

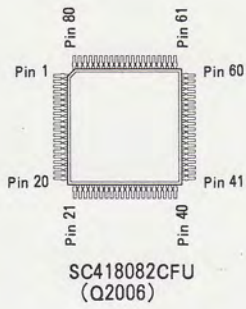

SC418082CFU (Q2006)

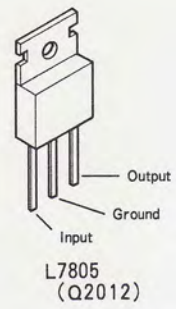

L7805 (Q2012)

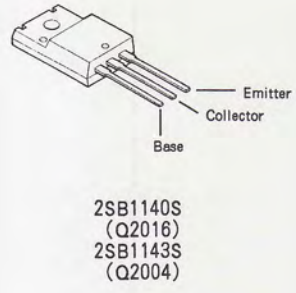

2SB1140S (Q2016)  
2SB1143S (Q2004)

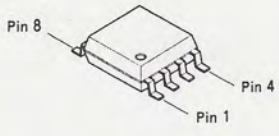

NJM2902M (Q2001,2007)

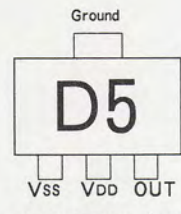

RH5VA45AA (D5) (Q2009)

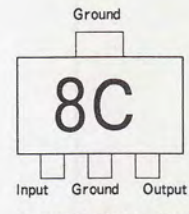

NJM78L05UA (8C) (Q2013)

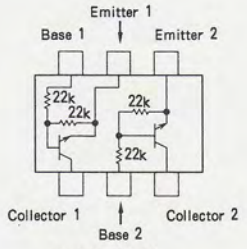

IMH5 (H5) (Q2011,2014)

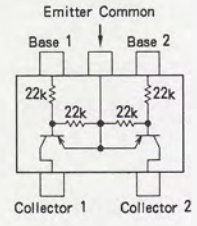

FMA1 (A1) (Q2015)

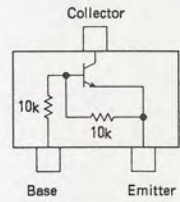

DTC114EK (24) (Q2002,2003,2010,2017)

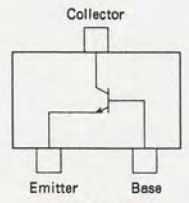

2SC1623 (L5) (Q2008)

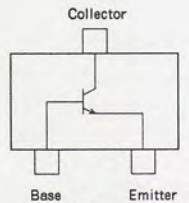

2SC2712GR (LG) (Q2005,2018)

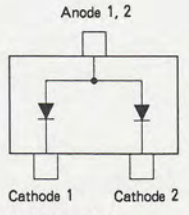

DAP202K (P) (Q2001,2003,2004,2005,2006,2008,2009)

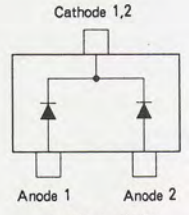

1SS321 (F9) (D2002)

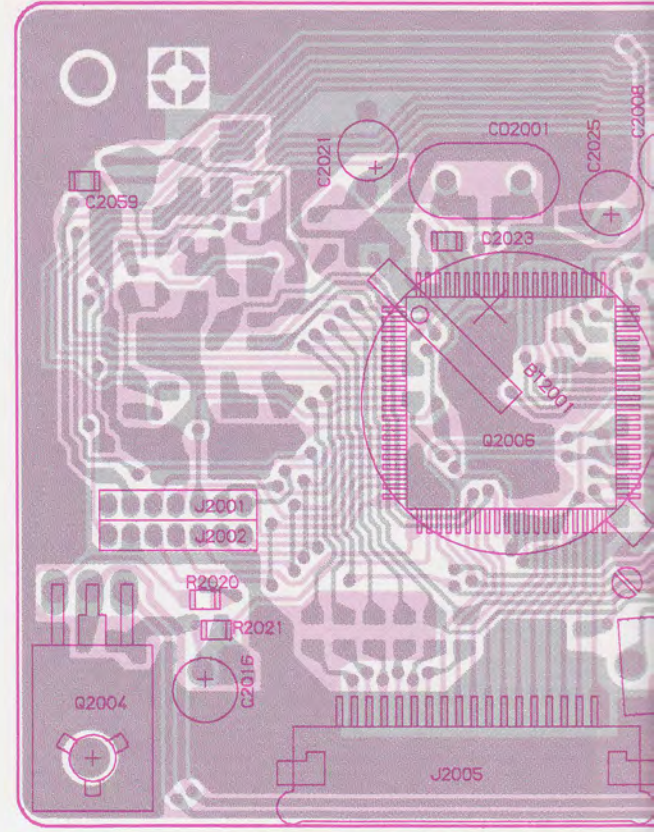

- 1. GND
  - 2. DIAL2
  - 3. DIAL1
  - 4. CE
  - 5. INH
  - 6. CLOCK
  - 7. DATA
  - 8. POWER
  - 9. D/M/R
  - 10. F/W
  - 11. REV
  - 12. MHz
  - 13. LOW
  - 14. RPT
  - 15. TONE
  - 16. PAGE
  - 17. CALL
  - 18. A/N
- To DISPLAY Unit J3001  
(See Page 3E-3)

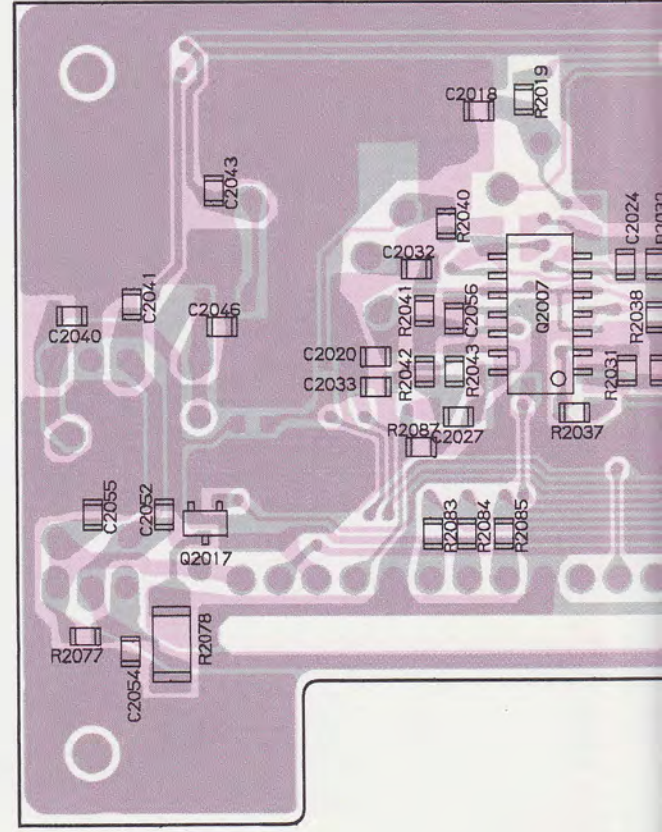

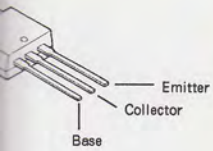

2SB1140S (Q2016)  
2SB1143S (Q2004)

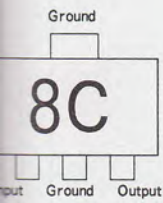

8C  
Input Ground Output

2JM78L05UA (8C) (Q2013)

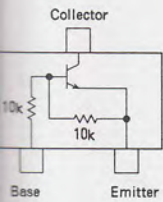

114EK (24)  
2002,2003,2010,2017)

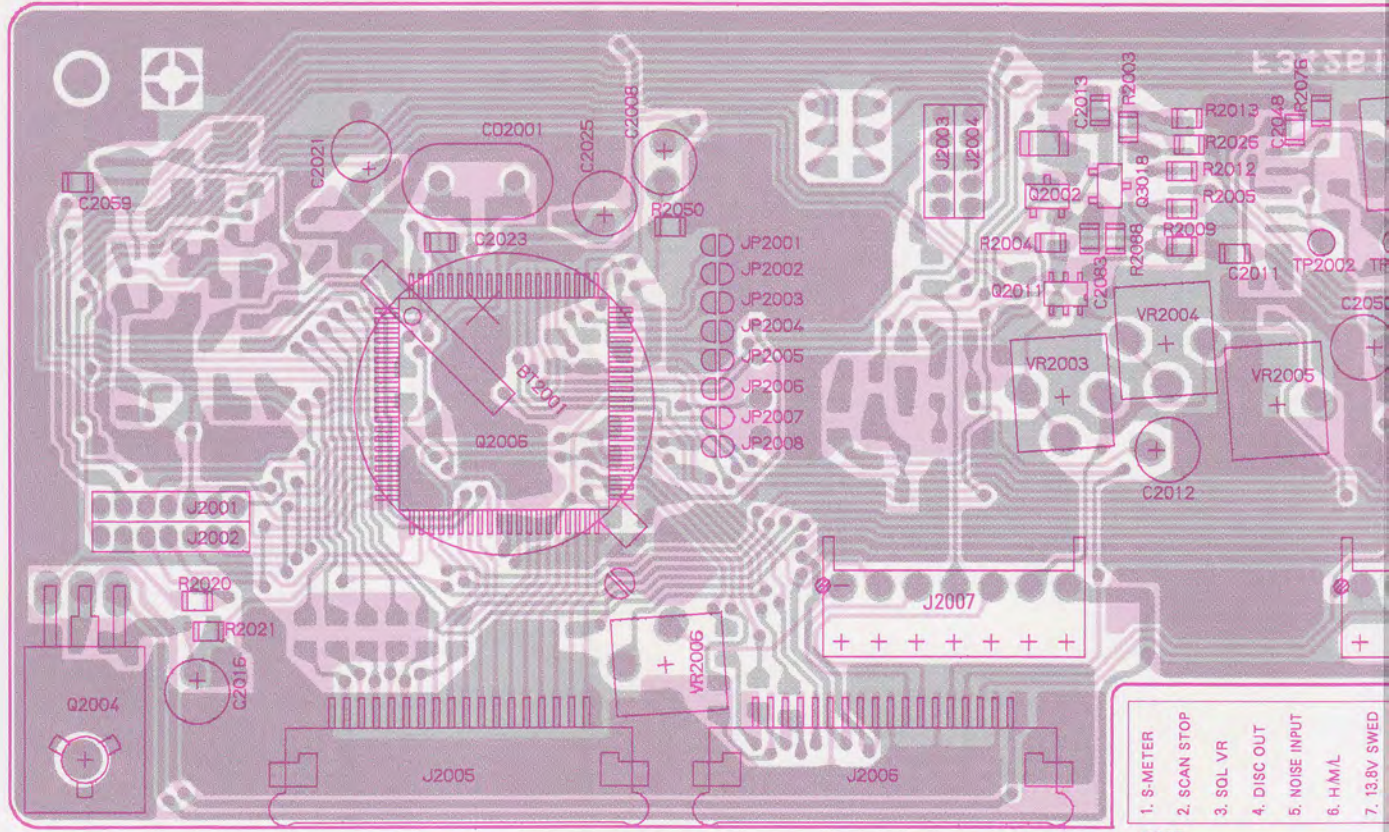

- To DISPLAY Unit J3001  
(See Page 3E-3)
1. GND
  2. DIAL2
  3. DIAL1
  4. CE
  5. INH
  6. CLOCK
  7. DATA
  8. POWER
  9. D/M/R
  10. F/W
  11. REV
  12. MHz
  13. LOW
  14. RPT
  15. TONE
  16. PAGE
  17. CALL
  18. A/N

- To DISPLAY Unit J3002  
(See Page 3E-3)
1. UP
  2. DOWN
  3. PTT
  4. ACC
  5. DIM
  6. GND
  7. SP
  8. 5V
  9. 5V
  10. GND
  11. SOL1
  12. SOL2
  13. GND
  14. AF
  15. MIC
  16. AF2
  17. GND
  18. DIMC

- J2007  
To MAIN Unit J1003  
(See Page 3B-4)
1. S-METER
  2. SCAN STOP
  3. SOL VR
  4. DISC OUT
  5. NOISE INPUT
  6. H/M/L
  7. 13.8V SWED
- J2008  
To M  
(See

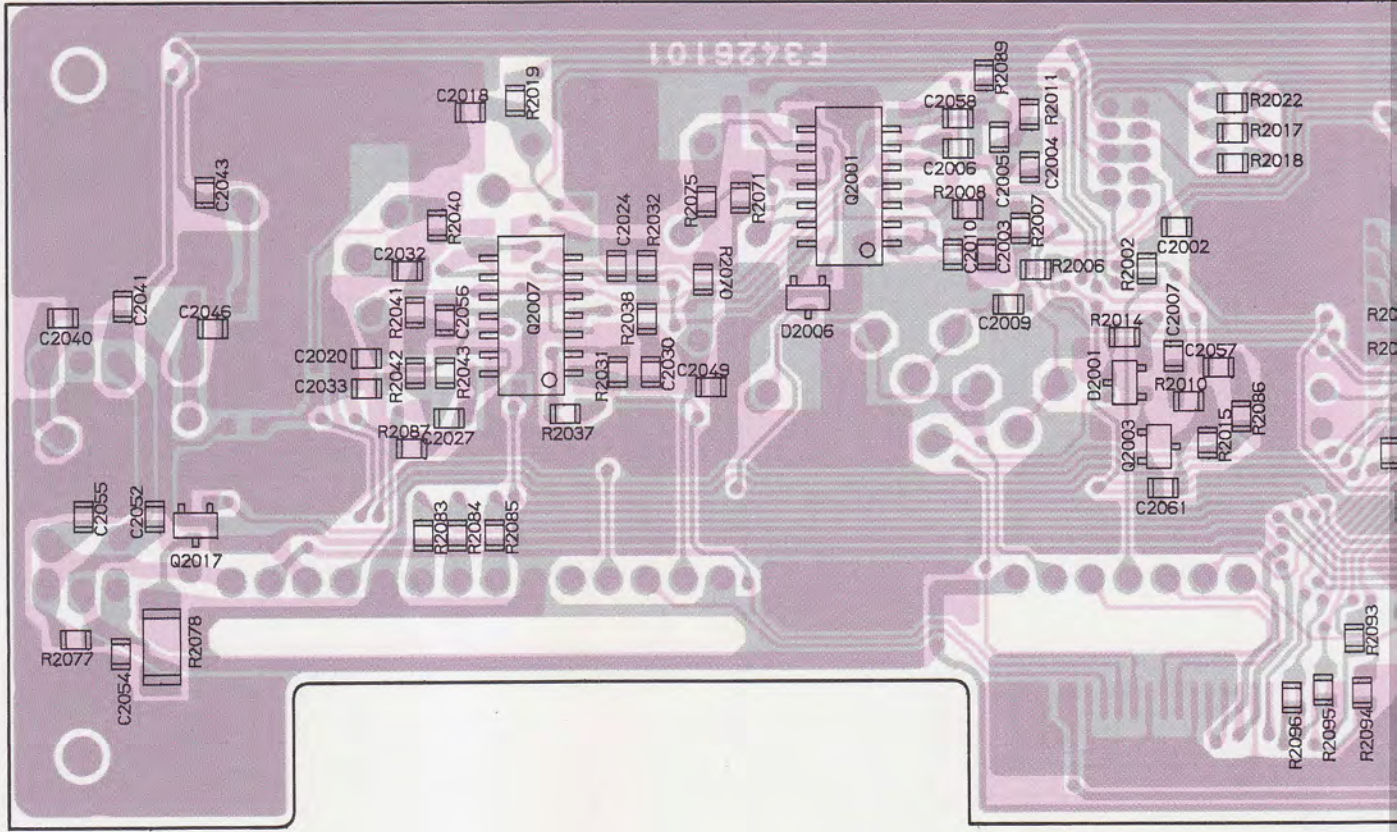

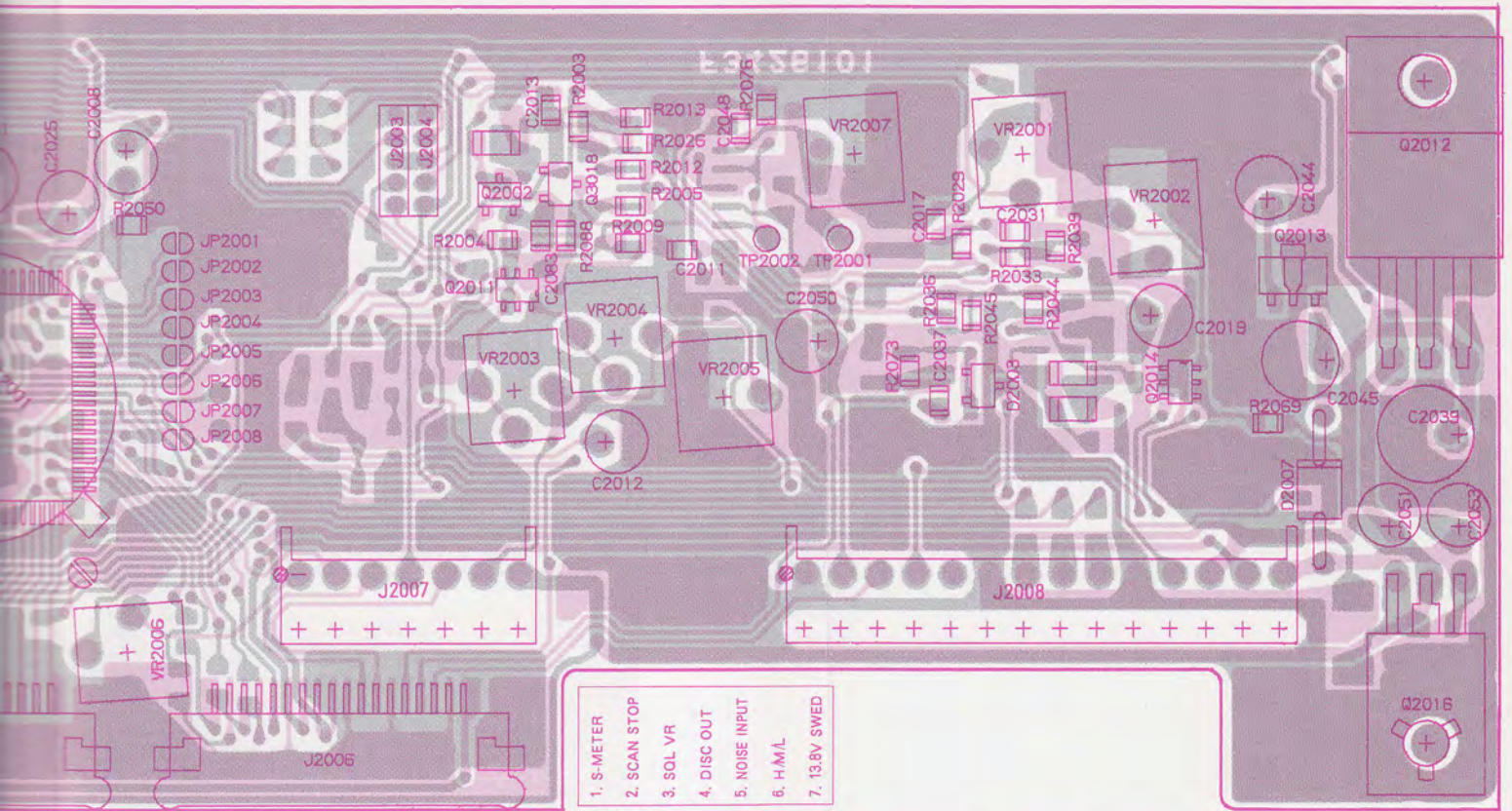

- 14. RPT
- 15. TONE
- 16. PAGE
- 17. CALL
- 18. A/N

- 1. UP
- 2. DOWN
- 3. PTT
- 4. ACC
- 5. DIM
- 6. GND
- 7. SP
- 8. 5V
- 9. 5V
- 10. GND
- 11. SOL1
- 12. SOL2
- 13. GND
- 14. AF
- 15. MIC
- 16. AF2
- 17. GND
- 18. DIMC

To DISPLAY Unit J3002  
(See Page 3E-3)

- 1. S-METER
- 2. SCAN STOP
- 3. SOL VR
- 4. DISC OUT
- 5. NOISE INPUT
- 6. H/M/L
- 7. 13.8V SWED

J2007  
To MAIN Unit J1003  
(See Page 3B-4)

- 1. GND
- 2. 9V
- 3. AF
- 4. T.R
- 5. NC
- 6. GND
- 7. PSTB
- 8. DATA
- 9. CLOCK
- 10. GND
- 11. MOD
- 12. 5V
- 13. AF SP
- 14. 13.8V

J2008  
To MAIN Unit J1002  
(See Page 3B-4)

component side

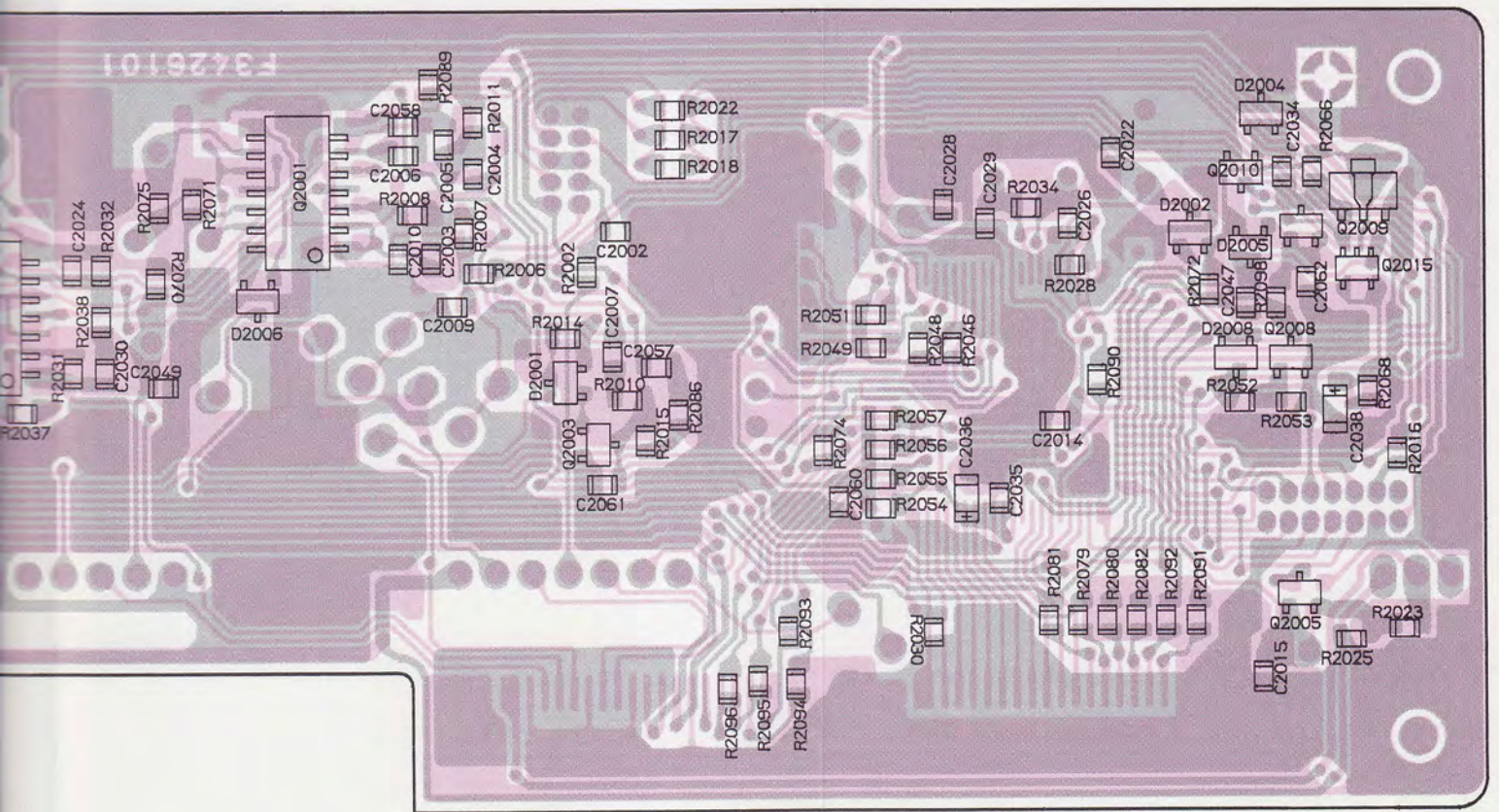

chip-only side



REF.	DESCRIPTION	VALUE	WV	TOL.	MFGR'S DESIG	YAESU P/N	VERS.
*** CNTL UNIT ***							
	PCB With Components					CA1258001	TYP A2
	PCB With Components					CA1258002	TYP A3
	PCB With Components					CA1258003	TYP B1
	PCB With Components					CA1258004	TYP B2
	PCB With Components					CA1258005	TYP B3
	Printed Circuit Board					F3426101	
BT2001	LITHIUM BATTERY				CR2016-TS1	Q9000552	
C 2002	CHIP CAP.	0.01uF	50V	B	GRM40B103M50PT	K22170817	
C 2003	CHIP CAP.	0.033uF	25V	B	GRM40B333M25PT	K22140810	
C 2004	CHIP CAP.	0.033uF	25V	B	GRM40B333M25PT	K22140810	
C 2005	CHIP CAP.	0.033uF	25V	B	GRM40B333M25PT	K22140810	
C 2006	CHIP CAP.	0.033uF	25V	B	GRM40B333M25PT	K22140810	
C 2007	CHIP CAP.	0.1uF	25V	B	GRM40B104M25PT	K22140811	
C 2008	TANTALUM CAP.	0.1uF	35V		DN1V0R1M1S	K70167104	
C 2009	CHIP CAP.	0.033uF	25V	B	GRM40B333M25PT	K22140810	
C 2010	CHIP CAP.	0.0082uF	50V	B	GRM40B822M50PT	K22170816	
C 2011	CHIP CAP.	0.1uF	25V	B	GRM40B104M25PT	K22140811	
C 2012	AL. ELECTRO. CAP.	3.3uF	50V		50V3R3M4X7TR2	K46170032	
C 2013	CHIP CAP.	0.1uF	25V	B	GRM40B104M25PT	K22140811	
C 2014	CHIP CAP.	0.1uF	25V	B	GRM40B104M25PT	K22140811	
C 2015	CHIP CAP.	0.1uF	25V	B	GRM40B104M25PT	K22140811	
C 2016	AL. ELECTRO. CAP.	3.3uF	50V		50V3R3M4X7TR2	K46170032	
C 2017	CHIP CAP.	0.001uF	50V	B	GRM40B102M50PT	K22170805	
C 2018	CHIP CAP.	0.001uF	50V	B	GRM40B102M50PT	K22170805	
C 2019	AL. ELECTRO. CAP.	10uF	16V		16V100M4X7TR2	K46120004	
C 2020	CHIP CAP.	0.001uF	50V	B	GRM40B102M50PT	K22170805	
C 2021	TANTALUM CAP.	3.3uF	10V		TPDN1A3R3M8S	K76100003	
C 2022	CHIP CAP.	0.01uF	50V	B	GRM40B103M50PT	K22170817	
C 2023	CHIP CAP.	68pF	50V	CH	GRM40CH680J50PT	K22170231	
C 2024	CHIP CAP.	10pF	50V	CH	GRM40CH100D50PT	K22170211	
C 2025	AL. ELECTRO. CAP.	10uF	16V		16V100M4X7TR2	K46120004	
C 2026	CHIP CAP.	39pF	50V	CH	GRM40CH390J50PT	K22170225	
C 2027	CHIP CAP.	0.0047uF	50V	B	GRM40B472M50PT	K22170813	
C 2028	CHIP CAP.	0.01uF	50V	B	GRM40B103M50PT	K22170817	
C 2029	CHIP CAP.	39pF	50V	CH	GRM40CH390J50PT	K22170225	
C 2030	CHIP CAP.	0.033uF	25V	B	GRM40B333M25PT	K22140810	
C 2032	CHIP CAP.	0.1uF	25V	B	GRM40B104M25PT	K22140811	
C 2033	CHIP CAP.	680pF	50V	B	GRM40B681M50PT	K22170803	
C 2034	CHIP CAP.	0.1uF	25V	B	GRM40B104M25PT	K22140811	
C 2035	CHIP CAP.	0.1uF	25V	B	GRM40B104M25PT	K22140811	
C 2036	TANTALUM CHIP CAP.	3.3uF	6.3V		TESVA0J335M1-8R	K78080021	
C 2037	CHIP CAP.	0.0022uF	50V	B	GRM40B222M50PT	K22170809	
C 2038	TANTALUM CHIP CAP.	2.2uF	6.3V		TESVA0J225M1-8R	K78080009	
C 2039	AL. ELECTRO. CAP.	100uF	16V		16V101M6X7TR2	K46120007	
C 2040	CHIP CAP.	0.001uF	50V	B	GRM40B102M50PT	K22170805	
C 2041	CHIP CAP.	0.001uF	50V	B	GRM40B102M50PT	K22170805	
C 2043	CHIP CAP.	0.01uF	50V	B	GRM40B103M50PT	K22170817	
C 2044	AL. ELECTRO. CAP.	47uF	6.3V		RC2-6V470M-T34	K46080005	
C 2045	AL. ELECTRO. CAP.	47uF	16V		RC2-16V470M-T34	K46120010	
C 2046	CHIP CAP.	0.01uF	50V	B	GRM40B103M50PT	K22170817	

# CNTL Unit

REF.	DESCRIPTION	VALUE	WV	TOL.	MFGR'S DESIG	YAESU P/N	VERS.
C 2047	CHIP CAP.	0.022uF	50V	B	GRM40B223M50PT	K22170821	
C 2048	CHIP CAP.	0.1uF	25V	B	GRM40B104M25PT	K22140811	
C 2049	CHIP CAP.	0.001uF	50V	B	GRM40B102M50PT	K22170805	
C 2050	AL. ELECTRO. CAP.	10uF	16V		16V100M4X7TR2	K46120004	
C 2051	AL. ELECTRO. CAP.	10uF	16V		16V100M4X7TR2	K46120004	
C 2052	CHIP CAP.	0.001uF	50V	B	GRM40B102M50PT	K22170805	
C 2053	AL. ELECTRO. CAP.	10uF	16V		16V100M4X7TR2	K46120004	
C 2054	CHIP CAP.	0.001uF	50V	B	GRM40B102M50PT	K22170805	
C 2055	CHIP CAP.	0.001uF	50V	B	GRM40B102M50PT	K22170805	
C 2056	CHIP CAP.	0.0022uF	50V	B	GRM40B222M50PT	K22170809	
C 2057	CHIP CAP.	0.01uF	50V	B	GRM40B103M50PT	K22170817	
C 2058	CHIP CAP.	0.0068uF	50V	B	GRM40B682M50PT	K22170815	
C 2059	CHIP CAP.	0.001uF	50V	B	GRM40B102M50PT	K22170805	
C 2060	CHIP CAP.	0.001uF	50V	B	GRM40B102M50PT	K22170805	
C 2061	CHIP CAP.	0.01uF	50V	B	GRM40B103M50PT	K22170817	
C 2062	CHIP CAP.	0.1uF	25V	B	GRM40B104M25PT	K22140811	
C 2063	CHIP CAP.	100pF	50V	CH	GRM40CH101J50PT	K22170235	
CO2001	CERAMIC OSC				CSA9.83MT	H7900620	
D 2001	DIODE				DAP202K T146	G2070180	
D 2002	DIODE				1SS321 TE85R	G2070076	
D 2003	DIODE				DAP202K T146	G2070180	
D 2004	DIODE				DAP202K T146	G2070180	
D 2005	DIODE				DAP202K T146	G2070180	
D 2006	DIODE				DAP202K T146	G2070180	
D 2007	DIODE				10E1	G2090306	
D 2008	DIODE				DAP202K T146	G2070180	
D 2009	DIODE				DAP202K T146	G2070180	
J 2001	CONNECTOR				9230B-1-07Z003-T	P0090857	
J 2002	CONNECTOR				9230B-1-07Z003-T	P0090857	
J 2003	CONNECTOR				9230B-1-05Z003-T	P0090856	
J 2004	CONNECTOR				9230B-1-05Z003-T	P0090856	
J 2005	CONNECTOR				00 6200 187 032 800	P1090653	
J 2006	CONNECTOR				00 6200 187 032 800	P1090653	
J 2007	CONNECTOR				9133S-07A	P1090838	
J 2008	CONNECTOR				9133S-14A	P1090839	
JP2001	CHIP RES.	0	1/16W	5%	RMC1/16 000JATP	J24185000	TYP A2
JP2001	CHIP RES.	0	1/16W	5%	RMC1/16 000JATP	J24185000	TYP A3
JP2002	CHIP RES.	0	1/16W	5%	RMC1/16 000JATP	J24185000	TYP A2
JP2002	CHIP RES.	0	1/16W	5%	RMC1/16 000JATP	J24185000	TYP A3
JP2003	CHIP RES.	0	1/16W	5%	RMC1/16 000JATP	J24185000	TYP B1
JP2003	CHIP RES.	0	1/16W	5%	RMC1/16 000JATP	J24185000	TYP B3
JP2006	CHIP RES.	0	1/16W	5%	RMC1/16 000JATP	J24185000	TYP B1
JP2006	CHIP RES.	0	1/16W	5%	RMC1/16 000JATP	J24185000	TYP B3
JP2007	CHIP RES.	0	1/16W	5%	RMC1/16 000JATP	J24185000	TYP A2
JP2007	CHIP RES.	0	1/16W	5%	RMC1/16 000JATP	J24185000	TYP A3
Q 2001	IC				NJM2902M-T2	G1090908	
Q 2002	TRANSISTOR				DTC114EK T96	G3070002	
Q 2003	TRANSISTOR				DTC114EK T96	G3070002	
Q 2004	TRANSISTOR				2SB1143S	G3211430S	
Q 2005	TRANSISTOR				2SC2712GR TE85R	G3327127G	

REF.	DESCRIPTION	VALUE	WV	TOL.	MFGR'S DESIG	YAESU P/N	VERS.
Q 2006	IC				SC418082CFU	G1091866	
Q 2007	IC				NJM2902M-T2	G1090908	
Q 2008	TRANSISTOR				2SC1623-T2BL5	G3316237E	
Q 2009	IC				RH5VA45AA-T1	G1090966	
Q 2010	TRANSISTOR				DTC114EK T96	G3070002	
Q 2011	TRANSISTOR				IMH5 T108	G3070027	
Q 2012	IC				L7805	G1090776	
Q 2013	IC				NJM78L05UA TE2	G1091325	
Q 2014	TRANSISTOR				IMH5 T108	G3070027	
Q 2015	TRANSISTOR				FMA1 T148	G3070089	
Q 2016	TRANSISTOR				2SB1140S	G3211400S	
Q 2017	TRANSISTOR				DTC114EK T96	G3070002	
Q 2018	TRANSISTOR				2SC2712GR TE85R	G3327127G	
R 2002	CHIP RES.	33K	1/10W	5%	RMC1/10T 333J	J24205333	
R 2003	CHIP RES.	180K	1/10W	5%	RMC1/10T 184J	J24205184	
R 2004	CHIP RES.	220K	1/10W	5%	RMC1/10T 224J	J24205224	
R 2005	CHIP RES.	2.2M	1/10W	5%	RMC1/10T 225J	J24205225	
R 2006	CHIP RES.	10K	1/10W	5%	RMC1/10T 103J	J24205103	
R 2007	CHIP RES.	10K	1/10W	5%	RMC1/10T 103J	J24205103	
R 2008	CHIP RES.	10K	1/10W	5%	RMC1/10T 103J	J24205103	
R 2009	CHIP RES.	220K	1/10W	5%	RMC1/10T 224J	J24205224	
R 2010	CHIP RES.	4.7K	1/10W	5%	RMC1/10T 472J	J24205472	
R 2011	CHIP RES.	15K	1/10W	5%	RMC1/10T 153J	J24205153	
R 2012	CHIP RES.	100K	1/10W	5%	RMC1/10T 104J	J24205104	
R 2013	CHIP RES.	4.7K	1/10W	5%	RMC1/10T 472J	J24205472	
R 2014	CHIP RES.	10K	1/10W	5%	RMC1/10T 103J	J24205103	
R 2015	CHIP RES.	4.7K	1/10W	5%	RMC1/10T 472J	J24205472	
R 2016	CHIP RES.	100K	1/10W	5%	RMC1/10T 104J	J24205104	
R 2017	CHIP RES.	1K	1/10W	5%	RMC1/10T 102J	J24205102	
R 2018	CHIP RES.	1K	1/10W	5%	RMC1/10T 102J	J24205102	
R 2019	CHIP RES.	10K	1/10W	5%	RMC1/10T 103J	J24205103	
R 2020	CHIP RES.	470	1/10W	5%	RMC1/10T 471J	J24205471	
R 2021	CHIP RES.	10K	1/10W	5%	RMC1/10T 103J	J24205103	
R 2022	CHIP RES.	1K	1/10W	5%	RMC1/10T 102J	J24205102	
R 2023	CHIP RES.	1.2K	1/10W	5%	RMC1/10T 122J	J24205122	
R 2025	CHIP RES.	680	1/10W	5%	RMC1/10T 681J	J24205681	
R 2026	CHIP RES.	180K	1/10W	5%	RMC1/10T 184J	J24205184	
R 2028	CHIP RES.	100K	1/10W	5%	RMC1/10T 104J	J24205104	
R 2029	CHIP RES.	560K	1/10W	5%	RMC1/10T 564J	J24205564	
R 2030	CHIP RES.	4.7K	1/10W	5%	RMC1/10T 472J	J24205472	
R 2031	CHIP RES.	560K	1/10W	5%	RMC1/10T 564J	J24205564	
R 2032	CHIP RES.	1.5M	1/10W	5%	RMC1/10T 155J	J24205155	
R 2033	CHIP RES.	150K	1/10W	5%	RMC1/10T 154J	J24205154	
R 2034	CHIP RES.	1M	1/10W	5%	RMC1/10T 105J	J24205105	
R 2036	CHIP RES.	10K	1/10W	5%	RMC1/10T 103J	J24205103	
R 2037	CHIP RES.	4.7K	1/10W	5%	RMC1/10T 472J	J24205472	
R 2038	CHIP RES.	15K	1/10W	5%	RMC1/10T 153J	J24205153	
R 2039	CHIP RES.	220K	1/10W	5%	RMC1/10T 224J	J24205224	
R 2040	CHIP RES.	2.2K	1/10W	5%	RMC1/10T 222J	J24205222	
R 2041	CHIP RES.	22K	1/10W	5%	RMC1/10T 223J	J24205223	
R 2042	CHIP RES.	22K	1/10W	5%	RMC1/10T 223J	J24205223	
R 2043	CHIP RES.	22K	1/10W	5%	RMC1/10T 223J	J24205223	
R 2044	CHIP RES.	2.2M	1/10W	5%	RMC1/10T 225J	J24205225	
R 2045	CHIP RES.	8.2K	1/10W	5%	RMC1/10T 822J	J24205822	
R 2046	CHIP RES.	10K	1/10W	5%	RMC1/10T 103J	J24205103	

# CNTL Unit

REF.	DESCRIPTION	VALUE	WV	TOL.	MFGR'S DESIG	YAESU P/N	VERS.
R 2048	CHIP RES.	22K	1/10W	5%	RMC1/10T 223J	J24205223	
R 2049	CHIP RES.	39K	1/10W	5%	RMC1/10T 393J	J24205393	
R 2050	CHIP RES.	3.3K	1/10W	5%	RMC1/10T 332J	J24205332	
R 2051	CHIP RES.	82K	1/10W	5%	RMC1/10T 823J	J24205823	
R 2052	CHIP RES.	47K	1/10W	5%	RMC1/10T 473J	J24205473	
R 2053	CHIP RES.	100K	1/10W	5%	RMC1/10T 104J	J24205104	
R 2054	CHIP RES.	22K	1/10W	5%	RMC1/10T 223J	J24205223	
R 2055	CHIP RES.	22K	1/10W	5%	RMC1/10T 223J	J24205223	
R 2056	CHIP RES.	22K	1/10W	5%	RMC1/10T 223J	J24205223	
R 2057	CHIP RES.	22K	1/10W	5%	RMC1/10T 223J	J24205223	
R 2066	CHIP RES.	1K	1/10W	5%	RMC1/10T 102J	J24205102	
R 2068	CHIP RES.	10K	1/10W	5%	RMC1/10T 103J	J24205103	
R 2069	CHIP RES.	1K	1/10W	5%	RMC1/10T 102J	J24205102	
R 2070	CHIP RES.	27K	1/10W	5%	RMC1/10T 273J	J24205273	
R 2071	CHIP RES.	1.8K	1/10W	5%	RMC1/10T 182J	J24205182	
R 2072	CHIP RES.	10K	1/10W	5%	RMC1/10T 103J	J24205103	
R 2073	CHIP RES.	4.7K	1/10W	5%	RMC1/10T 472J	J24205472	
R 2074	CHIP RES.	47K	1/10W	5%	RMC1/10T 473J	J24205473	
R 2075	CHIP RES.	1.8K	1/10W	5%	RMC1/10T 182J	J24205182	
R 2076	CHIP RES.	33K	1/10W	5%	RMC1/10T 333J	J24205333	
R 2077	CHIP RES.	4.7K	1/10W	5%	RMC1/10T 472J	J24205472	
R 2078	CHIP RES.	470	1/2W	5%	RMC1/2 471JCTP	J24275471	
R 2079	CHIP RES.	10K	1/10W	5%	RMC1/10T 103J	J24205103	
R 2080	CHIP RES.	10K	1/10W	5%	RMC1/10T 103J	J24205103	
R 2081	CHIP RES.	10K	1/10W	5%	RMC1/10T 103J	J24205103	
R 2082	CHIP RES.	10K	1/10W	5%	RMC1/10T 103J	J24205103	
R 2083	CHIP RES.	1K	1/10W	5%	RMC1/10T 102J	J24205102	
R 2084	CHIP RES.	1K	1/10W	5%	RMC1/10T 102J	J24205102	
R 2085	CHIP RES.	1K	1/10W	5%	RMC1/10T 102J	J24205102	
R 2086	CHIP RES.	47K	1/10W	5%	RMC1/10T 473J	J24205473	
R 2087	CHIP RES.	10K	1/10W	5%	RMC1/10T 103J	J24205103	
R 2088	CHIP RES.	3.3K	1/10W	5%	RMC1/10T 332J	J24205332	
R 2089	CHIP RES.	6.8K	1/10W	5%	RMC1/10T 682J	J24205682	
R 2090	CHIP RES.	1K	1/10W	5%	RMC1/10T 102J	J24205102	
R 2091	CHIP RES.	10K	1/10W	5%	RMC1/10T 103J	J24205103	
R 2092	CHIP RES.	10K	1/10W	5%	RMC1/10T 103J	J24205103	
R 2093	CHIP RES.	1K	1/10W	5%	RMC1/10T 102J	J24205102	
R 2094	CHIP RES.	1K	1/10W	5%	RMC1/10T 102J	J24205102	
R 2095	CHIP RES.	1K	1/10W	5%	RMC1/10T 102J	J24205102	
R 2096	CHIP RES.	1K	1/10W	5%	RMC1/10T 102J	J24205102	
R 2098	CHIP RES.	10K	1/10W	5%	RMC1/10T 103J	J24205103	
R 2099	CHIP RES.	0	1/10W	5%	RMC1/10T 000J	J24205000	
TP2001	TP-E/				MS-60124	Q5000016	
TP2002	TP-E/				MS-60124	Q5000016	
VR2001	POT.	50K			EVN-DXAA03B54	J51783503	
VR2002	POT.	10K			EVN-DXAA03B14	J51783103	
VR2003	POT.	10K			EVN-DXAA03B14	J51783103	
VR2004	POT.	2K			EVN-DXAA03B23	J51783202	
VR2005	POT.	10K			EVN-DXAA03B14	J51783103	
VR2006	POT.	50K			EVN-DXAA03B54	J51783503	
VR2007	POT.	20K			EVN-DXAA03B24	J51783203	
	RUBBER SPONGE					R7139760	
	SEAL					R8118690	

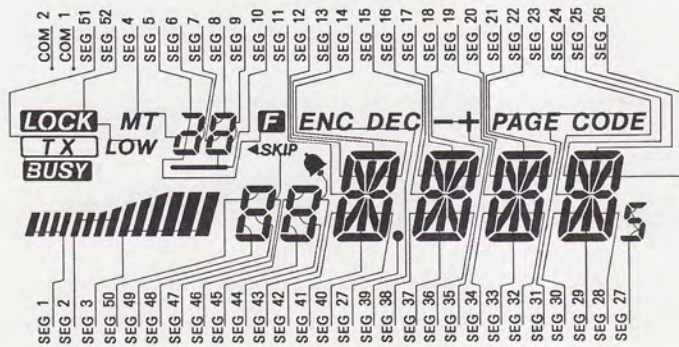
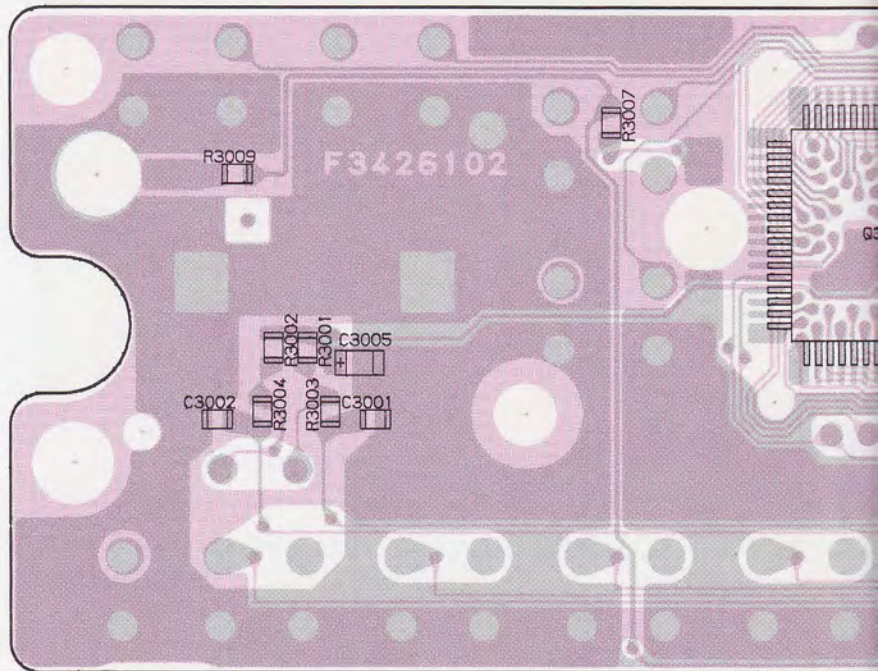
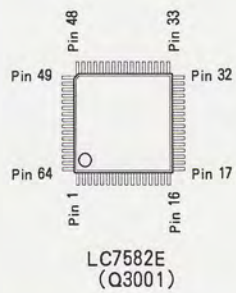
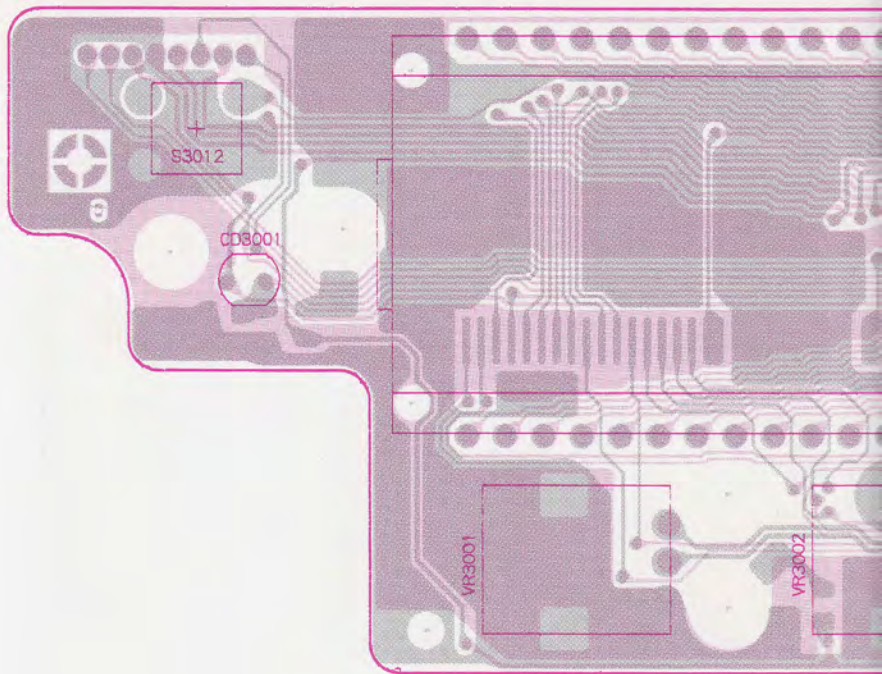

LCD Segmentation Circuit Diagram

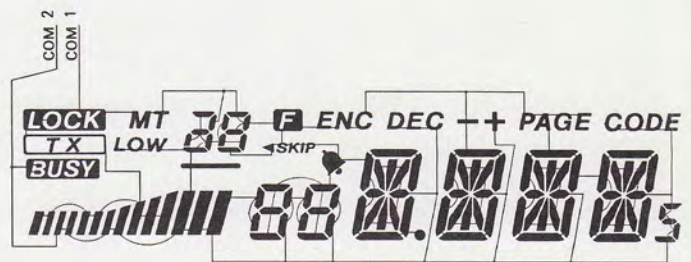

LCD Backplane Circuit Diagram

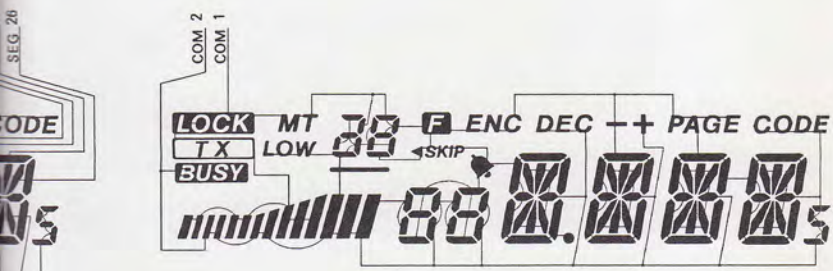
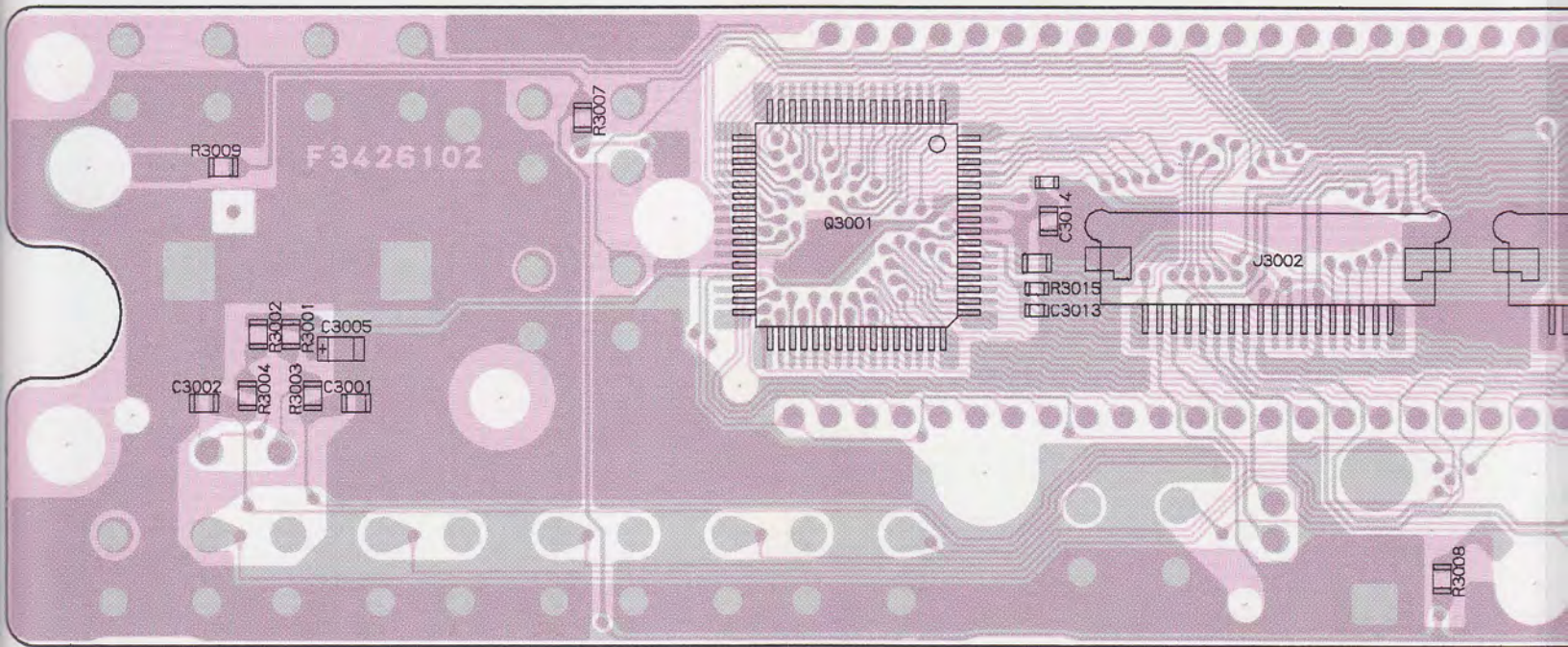
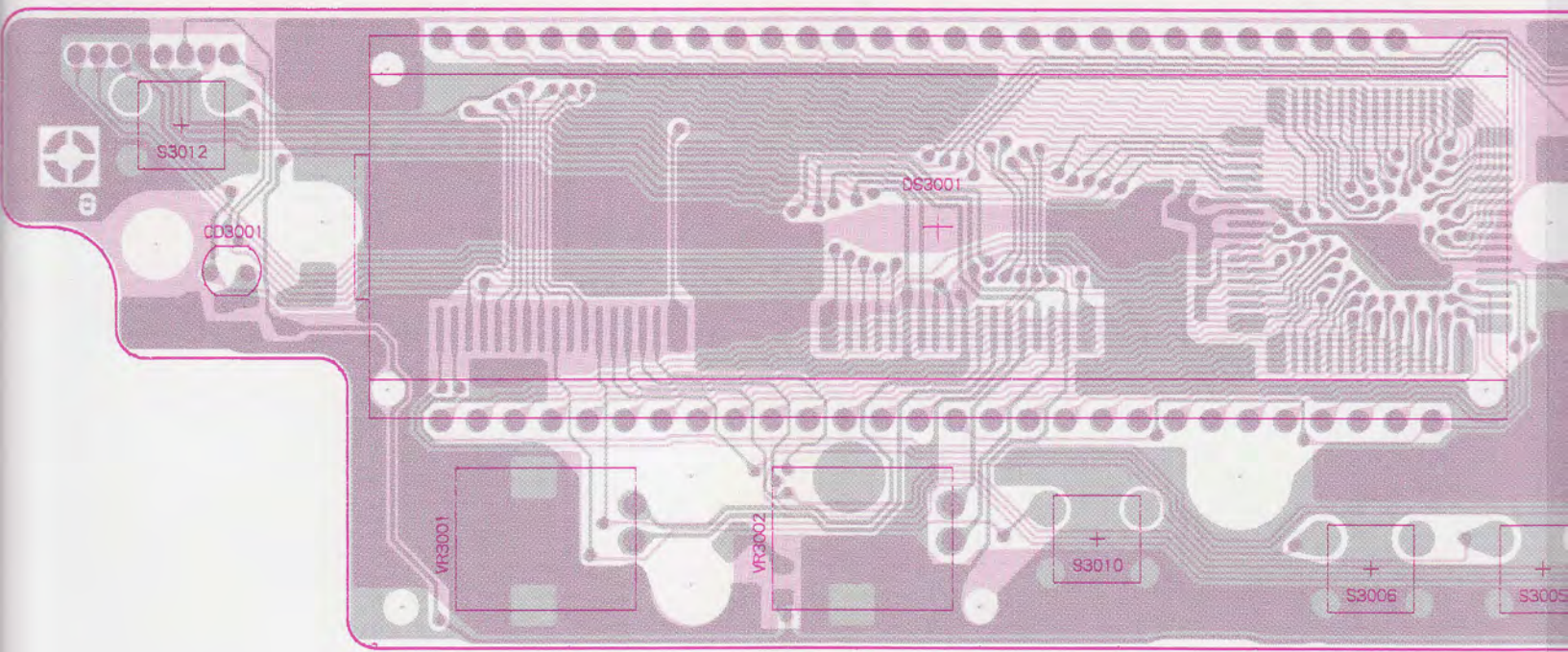

J3002  
To CNTL Unit J2006  
(See Page 3D-3)

18.	DIMC
17.	AF2
15.	MIC
14.	AF
13.	GND
12.	SOL2
11.	SOL1
10.	GND
9.	5V
8.	5V
7.	SP
6.	GND
5.	DIM
4.	ACC
3.	PTT
2.	DOWN
1.	UP

18.	A/N
17.	CALL
16.	PAGE

J3001  
To CN  
(See

LCD Backplane Circuit Diagram

# DISPLAY Unit

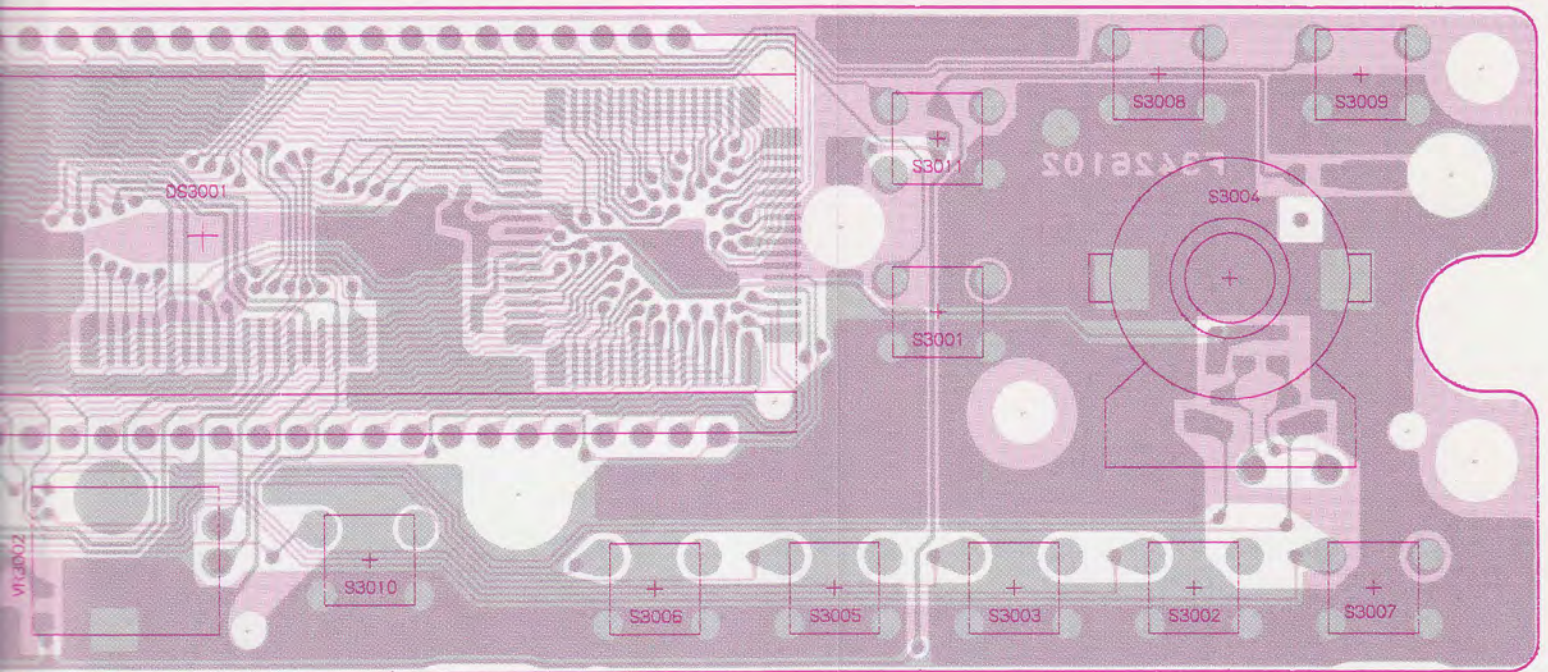

display side

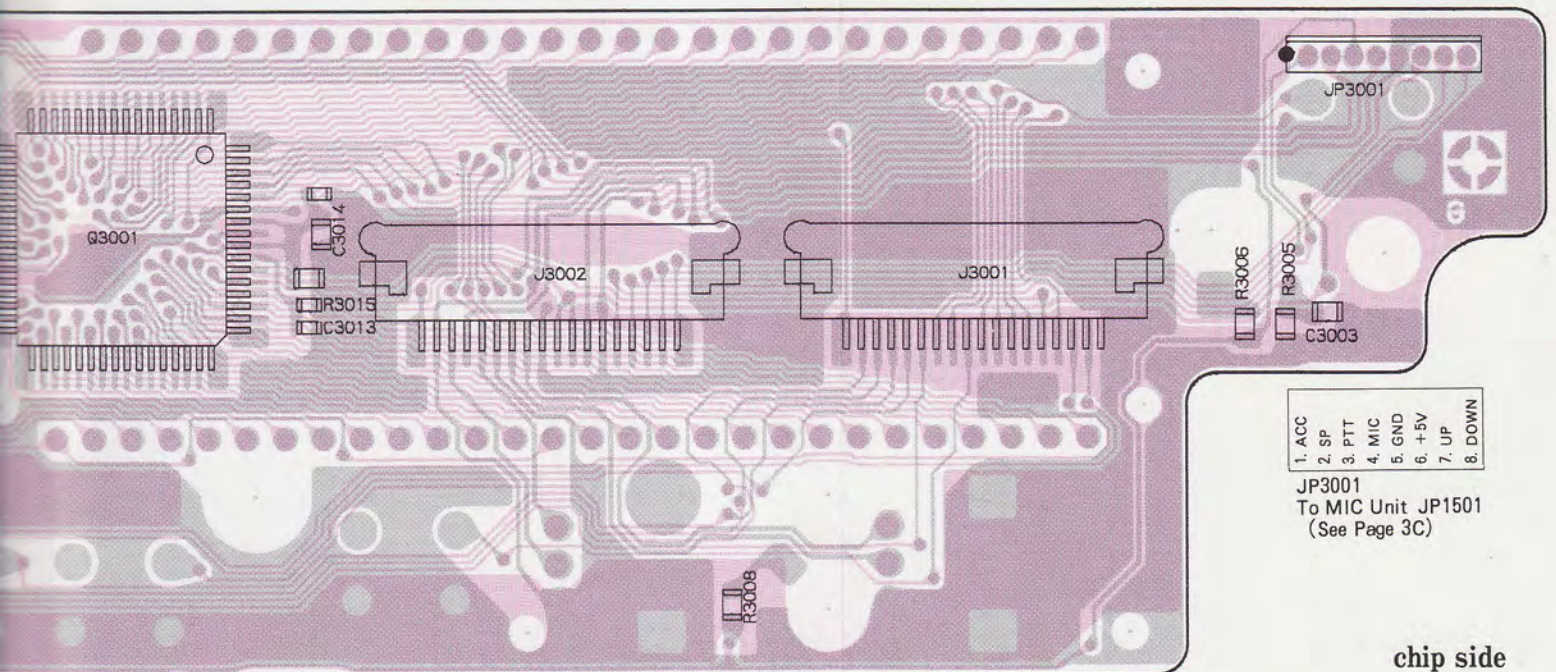

- |         |
|---------|
| 1. ACC  |
| 2. SP   |
| 3. PTT  |
| 4. MIC  |
| 5. GND  |
| 6. +5V  |
| 7. UP   |
| 8. DOWN |
- JP3001  
To MIC Unit JP1501  
(See Page 3C)

chip side

- |          |
|----------|
| 18. DIMC |
| 17. GND  |
| 16. AF2  |
| 15. MIC  |
| 14. AF   |
| 13. GND  |
| 12. SOL2 |
| 11. SOL1 |
| 10. GND  |
| 9. 5V    |
| 8. 5V    |
| 7. SP    |
| 6. GND   |
| 5. DIM   |
| 4. ACC   |
| 3. PTT   |
| 2. DOWN  |
| 1. UP    |

J3002  
To CNTL Unit J2006  
(See Page 3D-3)

- |          |
|----------|
| 18. A/N  |
| 17. CALL |
| 16. PAGE |
| 15. TONE |
| 14. RPT  |
| 13. LOW  |
| 12. MHz  |
| 11. REV  |
| 10. F/W  |
| 9. D/MR  |
| 8. POWER |
| 7. DATA  |
| 6. CLOCK |
| 5. INH   |
| 4. CE    |
| 3. DIAL1 |
| 2. DIAL2 |
| 1. GND   |

J3001  
To CNTL Unit J2005  
(See Page 3D-3)

CODE





To CNTL Unit J2005  
(See Page 3D-1)

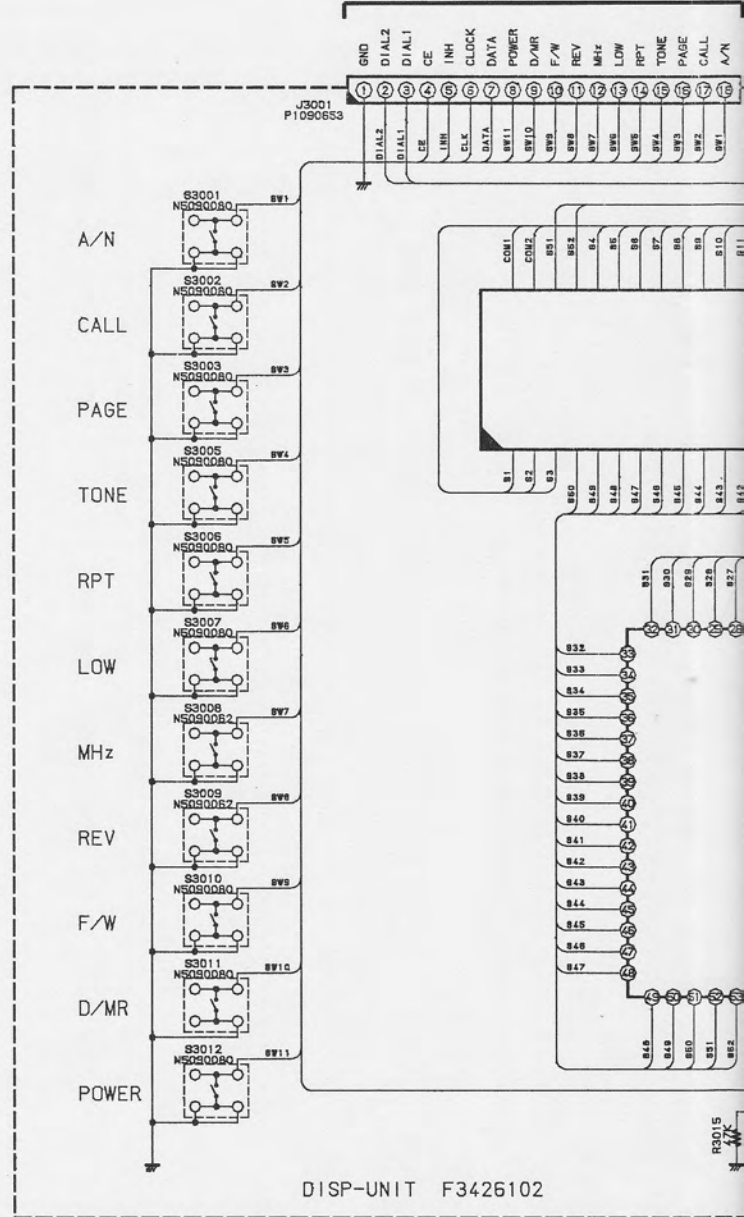



To CNTL Unit J2005  
(See Page 3D-1)

To CNTL  
(See Pa)

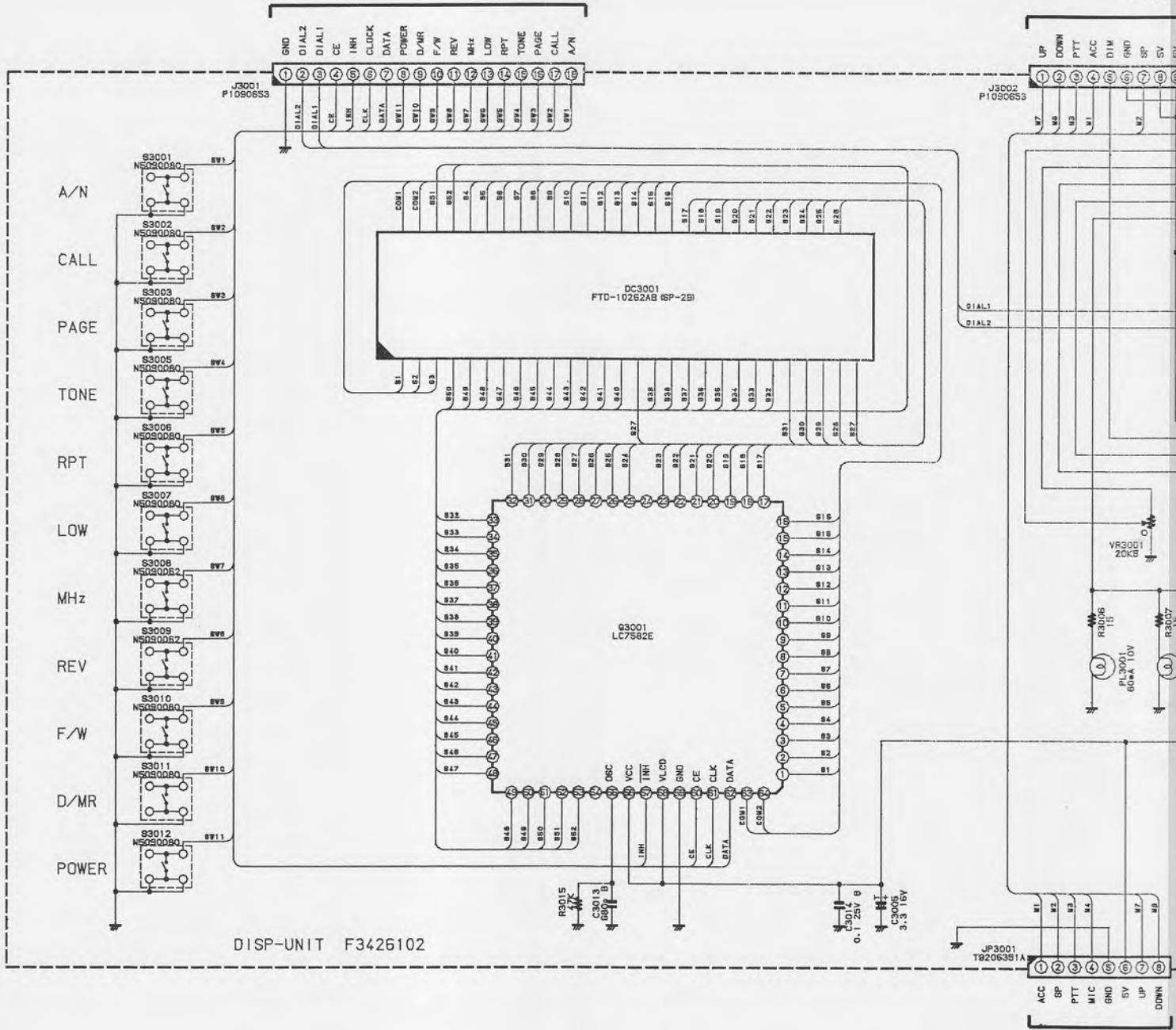

To MIC Unit JP1501  
(See Page 3C)

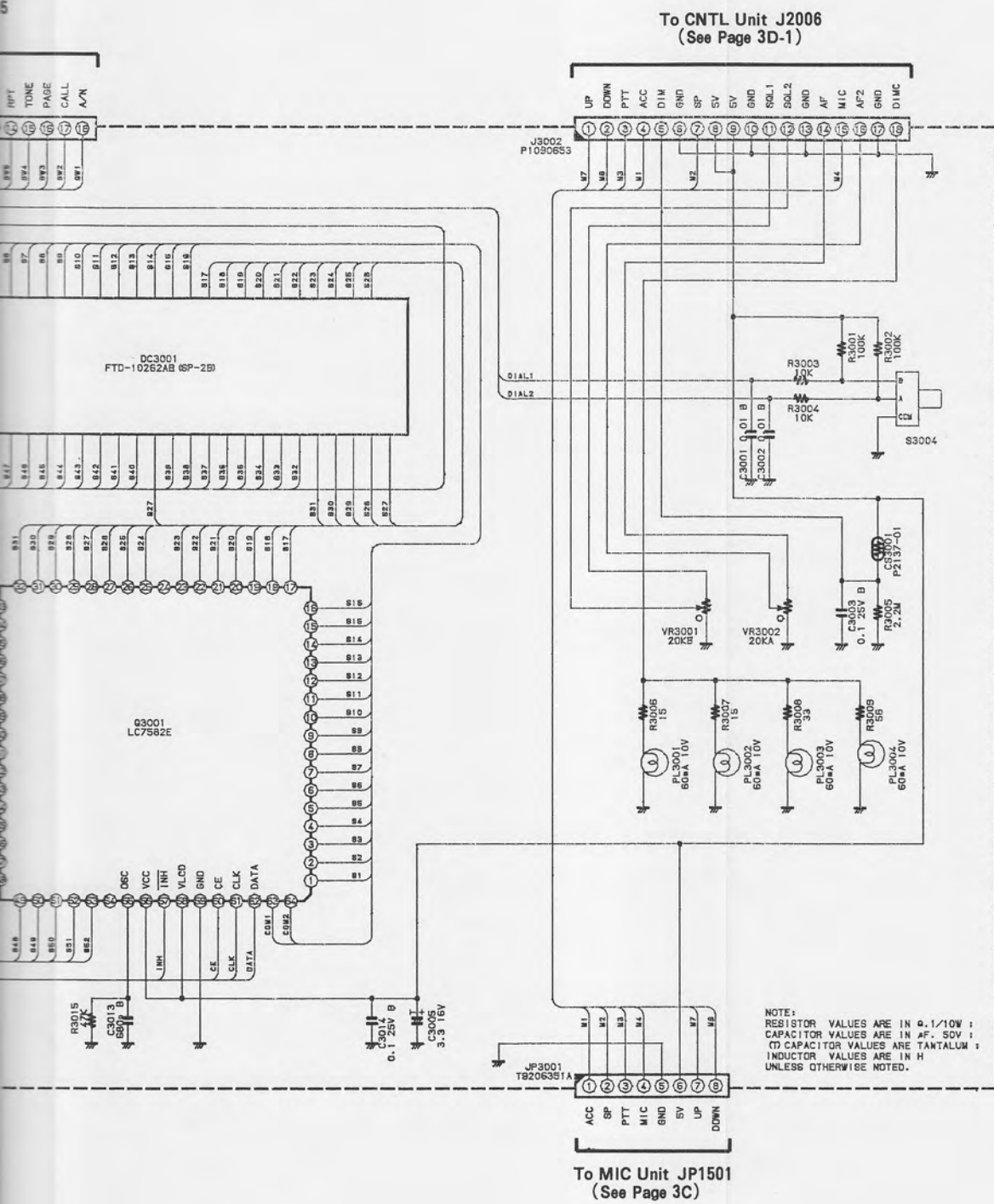

# DISPLAY Unit

REF.	DESCRIPTION	VALUE	WV	TOL.	MFGR'S DESIG	YAESU P/N	VERS.
*** DISPLAY UNIT ***							
	PCB With Components (W/O LIGHT GUIDE(2pcs), NYLON RIVET)					CS1367001	
	Printed Circuit Board					F3426102	
C 3001	CHIP CAP.	0.01uF	50V	B	GRM40B103M50PT	K22170817	
C 3002	CHIP CAP.	0.01uF	50V	B	GRM40B103M50PT	K22170817	
C 3003	CHIP CAP.	0.1uF	25V	B	GRM40B104M25PT	K22140811	
C 3005	TANTALUM CHIP CAP.	3.3uF	16V		TEMSVA1C335M-8R	K78120021	
C 3013	CHIP CAP.	680pF	50V	B	GRM39B681M50PT	K22174807	
C 3014	CHIP CAP.	0.1uF	25V	B	GRM40B104M25PT	K22140811	
CS3001	CDS				P2137-01	G9090056	
DS3001	LCD				FTD-10262AB(SP-2B)	G6090086A	
J 3001	CONNECTOR				00 6200 187 032 800	P1090653	
J 3002	CONNECTOR				00 6200 187 032 800	P1090653	
PL3001	LAMP		10V		10-60T3F	Q1000083	
PL3002	LAMP		10V		10-60T3F	Q1000083	
PL3003	LAMP		10V		10-60T3F	Q1000083	
PL3004	LAMP		10V		10-60T3F	Q1000083	
Q 3001	IC				LC7582E	G1091496	
R 3001	CHIP RES.	100K	1/10W	5%	RMC1/10T 104J	J24205104	
R 3002	CHIP RES.	100K	1/10W	5%	RMC1/10T 104J	J24205104	
R 3003	CHIP RES.	10K	1/10W	5%	RMC1/10T 103J	J24205103	
R 3004	CHIP RES.	10K	1/10W	5%	RMC1/10T 103J	J24205103	
R 3005	CHIP RES.	2.2M	1/10W	5%	RMC1/10T 225J	J24205225	
R 3006	CHIP RES.	15	1/10W	5%	RMC1/10T 150J	J24205150	
R 3007	CHIP RES.	15	1/10W	5%	RMC1/10T 150J	J24205150	
R 3008	CHIP RES.	33	1/10W	5%	RMC1/10T 330J	J24205330	
R 3009	CHIP RES.	56	1/10W	5%	RMC1/10T 560J	J24205560	
R 3015	CHIP RES.	47K	1/16W	5%	RMC1/16 473JATP	J24185473	
S 3001	TACT SWITCH				SKHHDU	N5090080	
S 3002	TACT SWITCH				SKHHDU	N5090080	
S 3003	TACT SWITCH				SKHHDU	N5090080	
S 3004	ROTARY CODE SW				EVQ-WP9F1524B	Q9000626	
S 3005	TACT SWITCH				SKHHDU	N5090080	
S 3006	TACT SWITCH				SKHHDU	N5090080	
S 3007	TACT SWITCH				SKHHDU	N5090080	
S 3008	TACT SWITCH				SKHHAP	N5090062	
S 3009	TACT SWITCH				SKHHAP	N5090062	
S 3010	TACT SWITCH				SKHHDU	N5090080	
S 3011	TACT SWITCH				SKHHDU	N5090080	
S 3012	TACT SWITCH				SKHHDU	N5090080	
VR3001	POT.	20K		B	EVU-F2JFK1B24	J60800202	
VR3002	POT.	20K		A	EVU-F2JFK1A24	J60800201	
	LAMP GUIDE					R3516440	

# DISPLAY Unit

REF.	DESCRIPTION	VALUE	WV	TOL.	MFGR'S DESIG	YAESU P/N	VERS.
	LCD HOLDER					R3516450A	
	LIGHT GUIDE					R3520070	
	LIGHT GUIDE					R3520080	
	REFLECTOR					R7139670A	
	SHEET (A)					R7140070	
	SHEET					R7149850	
	LED SPACER (2pcs)				LH-5-3	S6000236	
	LED SPACER				LH-5-9	S6000242	
	NYLON RIVET				NRP-380	S6000314	

# FRC-6 DTMF Paging Unit (option)

- 1. OUT
- 2. R/W
- 3. CS
- 4. RSO
- 5. O2
- 6. IRQ/CP
- 7. D0
- 8. D1
- 9. D2
- 10. D3
- 11. GND
- 12. +5V
- 13. IN
- 14. N.C.

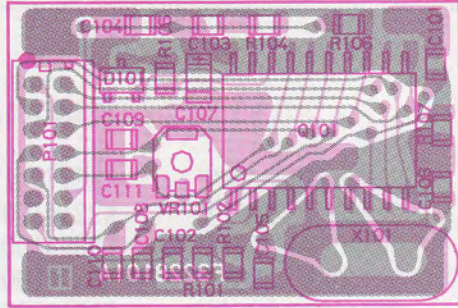

connector side

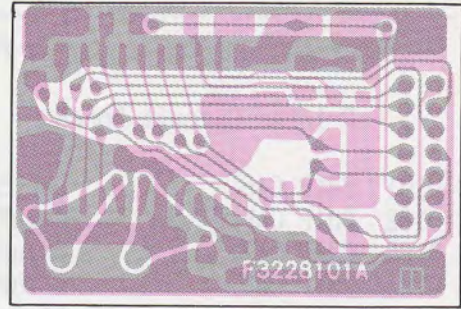

solder side

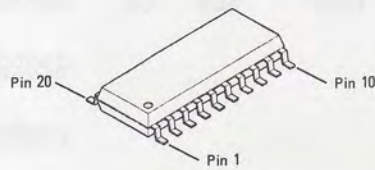

CM8880SIT-2 (Q101)

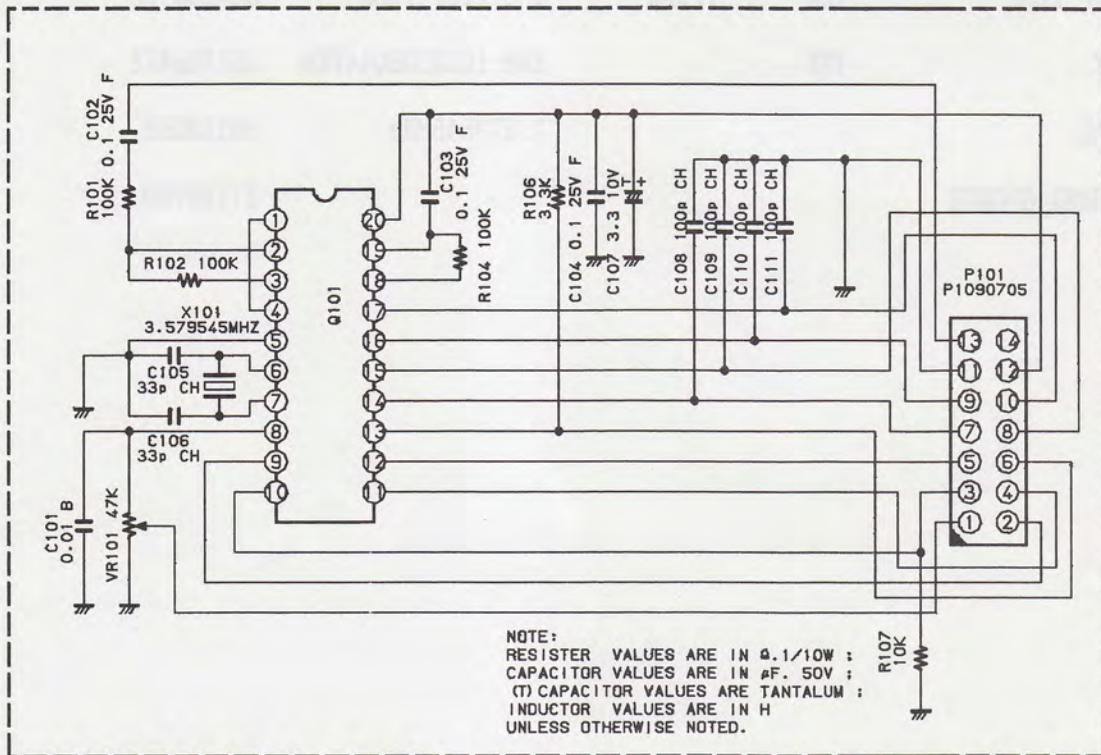

- IN N.C
- GND +5V
- D2 D3
- D0 D1
- O2  $\overline{TRQ/CP}$
- CS RSO
- OUT R/W

NOTE:  
 RESISTOR VALUES ARE IN Ω, 1/10W ;  
 CAPACITOR VALUES ARE IN µF, 50V ;  
 (T) CAPACITOR VALUES ARE TANTALUM ;  
 INDUCTOR VALUES ARE IN H  
 UNLESS OTHERWISE NOTED.

# FRC-6 DTMF Paging Unit (option)

REF.	DESCRIPTION	VALUE	WV	TOL.	MFGR'S DESIG.	YAESU P/N	VERS.
*** FRC-6 ***							
	Printed Circuit Board					F3228101A	
C 0101	CHIP CAP.	0.01uF	50V	B	GRM40B103M50PT	K22170817	
C 0102	CHIP CAP.	0.1uF	25V	F	GRM40F104Z25PT	K22141005	
C 0103	CHIP CAP.	0.1uF	25V	F	GRM40F104Z25PT	K22141005	
C 0104	CHIP CAP.	0.1uF	25V	F	GRM40F104Z25PT	K22141005	
C 0105	CHIP CAP.	33pF	50V	CH	GRM40CH330J50PT	K22170223	
C 0106	CHIP CAP.	33pF	50V	CH	GRM40CH330J50PT	K22170223	
C 0107	TANTALUM CHIP CAP.	3.3uF	10V		TEMSVA1A335M-8R	K78100015	
C 0108	CHIP CAP.	100pF	50V	CH	GRM40CH101J50PT	K22170235	
C 0109	CHIP CAP.	100pF	50V	CH	GRM40CH101J50PT	K22170235	
C 0110	CHIP CAP.	100pF	50V	CH	GRM40CH101J50PT	K22170235	
C 0111	CHIP CAP.	100pF	50V	CH	GRM40CH101J50PT	K22170235	
P 0101	CONNECTOR				52022-1410	P1090705	
Q 0101	IC				CM8880SIT-2	G1091344	
R 0101	CHIP RES.	100K	1/10W		RMC1/10T 104J	J24205104	
R 0102	CHIP RES.	100K	1/10W		RMC1/10T 104J	J24205104	
R 0104	CHIP RES.	100K	1/10W		RMC1/10T 104J	J24205104	
R 0106	CHIP RES.	3.3K	1/10W		RMC1/10T 332J	J24205332	
R 0107	CHIP RES.	10K	1/10W		RMC1/10T 103J	J24205103	
VR0101	POT.	47K			EVM-1USX30BQ447KB	J51789473	
X 0101	XTAL				3.579545MHz	H0103055	
	RUBBER SPONGE					R7139760	

# FTS-17A CTCSS Tone Squelch Unit (option)

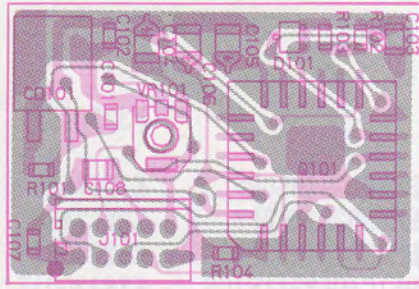

connector side

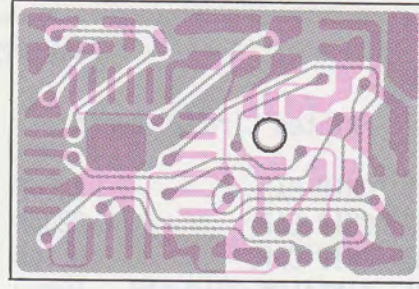

solder side

- 1. GND
- 2. GND
- 3. CLOCK
- 4. T DET
- 5. DATA
- 6. T5
- 7. T STB
- 8. T SQL
- 9. CPU5
- 10. TONE

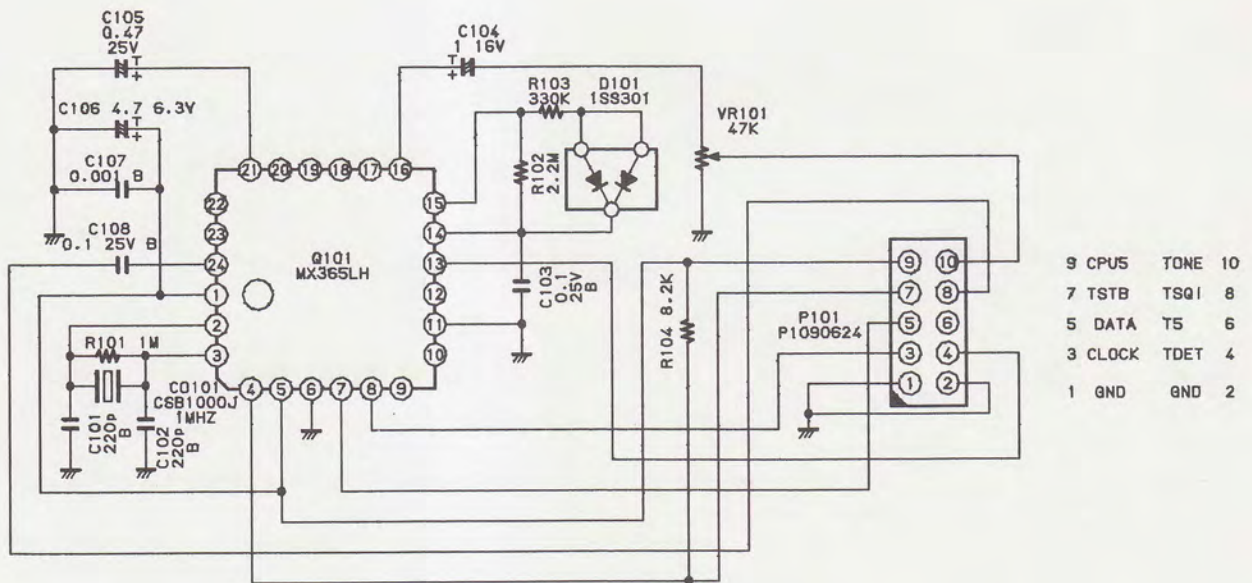
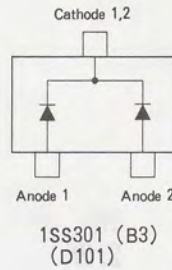
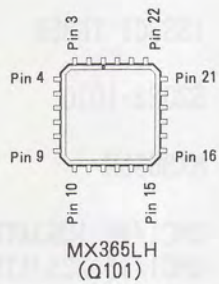

- 9 CPU5
- 7 TSTB
- 5 DATA
- 3 CLOCK
- 1 GND
- TONE 10
- TSQI 8
- T5 6
- TDET 4
- GND 2

NOTE:  
 RESISTOR VALUES ARE IN Ω, 1/16W ;  
 CAPACITOR VALUES ARE IN μF, 50V ;  
 (T) CAPACITOR VALUES ARE TANTALUM ;  
 UNLESS OTHERWISE NOTED.

# FTS-17A CTCSS Tone Squelch Unit (option)

REF.	DESCRIPTION	VALUE	WV	TOL.	MFGR'S DESIG.	YAESU P/N	VERS.
*** FTS-17A ***							
	Printed Circuit Board					F3220101	
C 0101	CHIP CAP.	220pF	50V	B	GRM39B221M50PT	K22174801	
C 0102	CHIP CAP.	220pF	50V	B	GRM39B221M50PT	K22174801	
C 0103	CHIP CAP.	0.1uF	25V	B	GRM40B104M25PT	K22140811	
C 0104	TANTALUM CHIP CAP.	1uF	16V		F951C105MRAAF1Q2	K78120013	
C 0105	TANTALUM CHIP CAP.	0.47uF	25V		F951E474MRAAF1Q2	K78140012	
C 0106	TANTALUM CHIP CAP.	4.7uF	6.3V		F950J475MSAAF1Q2	K78080002	
C 0107	CHIP CAP.	0.001uF	50V	B	GRM39B102M50PT	K22174809	
C 0108	CHIP CAP.	0.1uF	25V	B	GRM40B104M25PT	K22140811	
CO0101	CERAMIC OSC		1MHz		CSB1000J221T	H7900550	
D 0101	DIODE				1SS301 TE85R	G2070086	
P 0101	CONNECTOR				52022-1010	P1090624	
Q 0101	IC				MX365LH	G1090897	
R 0101	CHIP RES.	1M	1/16W		RMC1/16 105JATP	J24185105	
R 0102	CHIP RES.	2.2M	1/16W		RMC1/16 225JATP	J24185225	
R 0103	CHIP RES.	330K	1/16W		RMC1/16 334JATP	J24185334	
R 0104	CHIP RES.	8.2K	1/16W		RMC1/16 822JATP	J24185822	
VR0101	POT.	47K			EVM-1USX30BQ447KB	J51789473	
	SPONGE					R7130200	



# MH-26G8J Microphone (accessory)

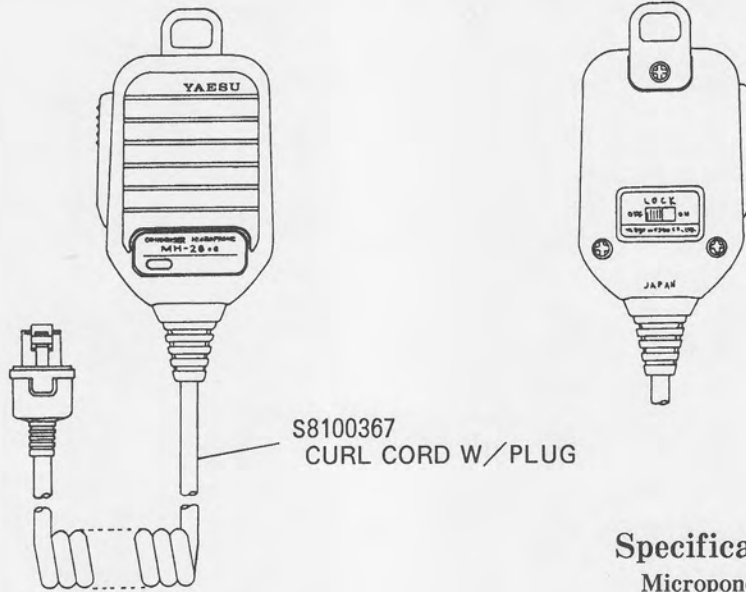

## Specifications

Microphone Impedance: 2.0kΩ  
 Operating Temperature Range: -10°C ~ +60°C  
 Voltage Requirement: 1.1V ~ 10V

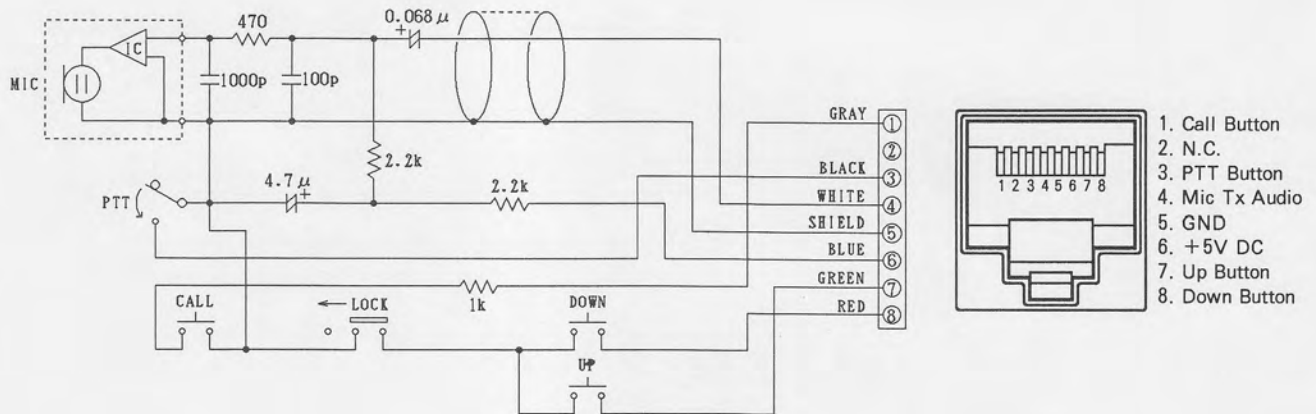

REF.	DESCRIPTION	VALUE	WV	TOL.	MFGR'S DESIG	YAESU P/N	VERS.
*** MH-26G8J ***							
	MIC ELEMENT				EM-78	M3290007	
	TACT SWITCH (3pcs)				SKHHLN	N5090036	

# MH-27<sub>A8J</sub> Microphone (accessory)

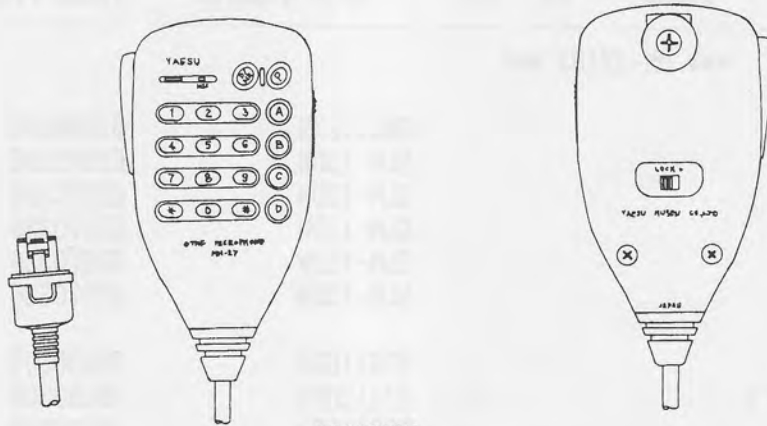

S8100227  
CURL CORD W/PLUG

## Specifications

Microphone Impedance: 1.5k $\Omega$   
 Operating Temperature Range: -10 $^{\circ}$ C ~ +60 $^{\circ}$ C  
 Voltage Requirement: 4.8V ~ 5.2V

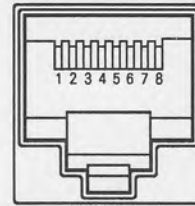

1. D/MR & P Button
2. N.C.
3. PTT Button
4. MicTx Audio
5. GND
6. +5V DC
7. Up Button
8. Down Button

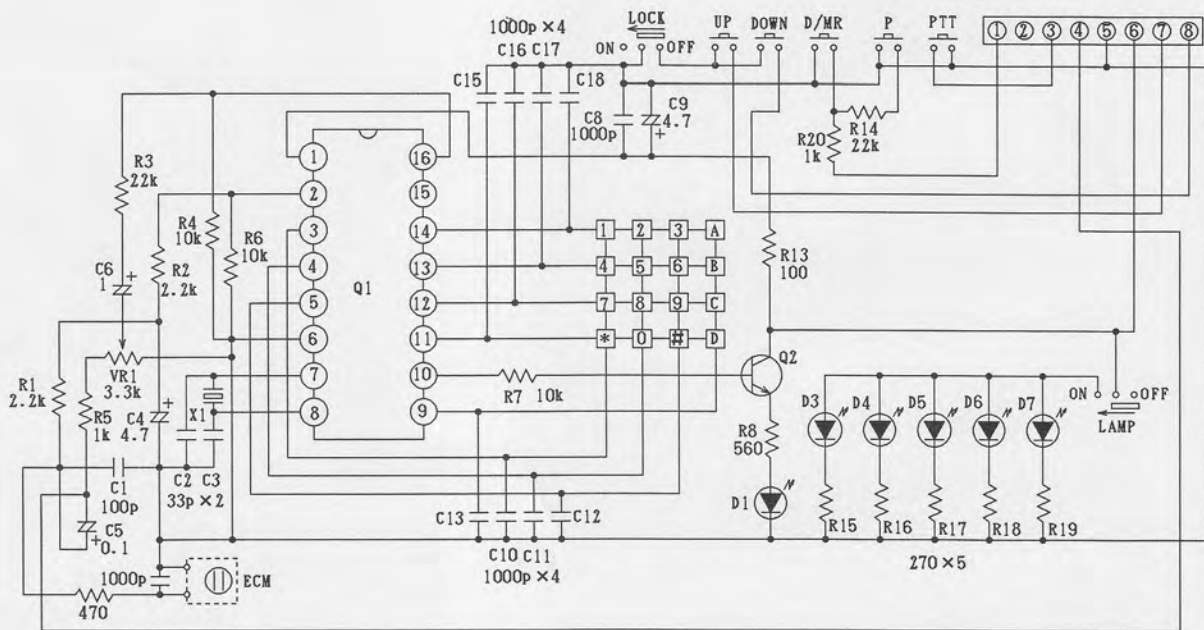

# MH-27A8J Microphone (accessory)

REF.	DESCRIPTION	VALUE	WV	TOL.	MFGR'S DESIG	YAESU P/N	VERS.
*** MH-27A8J ***							
D 0001	LED				SEL1123R	G2090576	
D 0003	LED				SLM-13DW	G2070326	
D 0004	LED				SLM-13DW	G2070326	
D 0005	LED				SLM-13DW	G2070326	
D 0006	LED				SLM-13DW	G2070326	
D 0007	LED				SLM-13DW	G2070326	
	MAIN UNIT ASS'Y				B76118G1	S8100307	
	KEYBOARD UNIT ASS'Y				B76120Y1	S8100308	
	SWITCH UNIT ASS'Y				B76119G1	S8100309	
	MIC ELEMENT				T006P70F0001	M3290021	

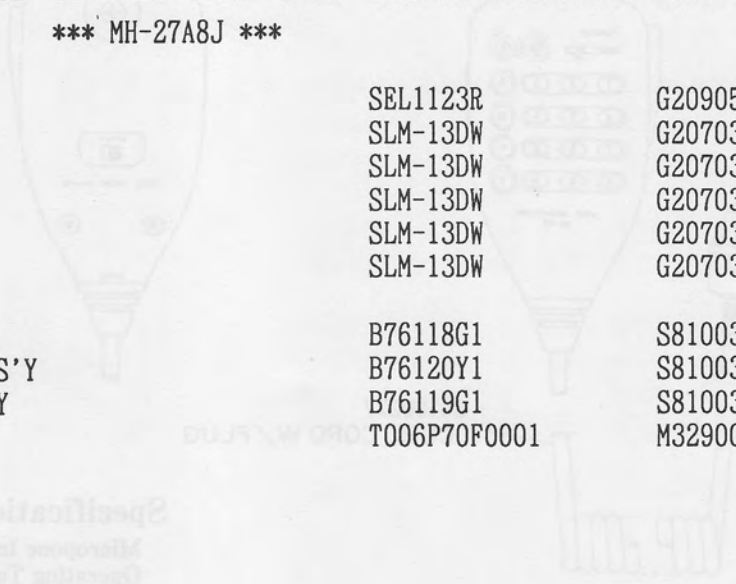

Specifications  
 Microphone Impedance: 1.5KΩ  
 Operating Temperature Range: -10°C ~ +50°C  
 Voltage Requirement: 1.8V ~ 2.5V

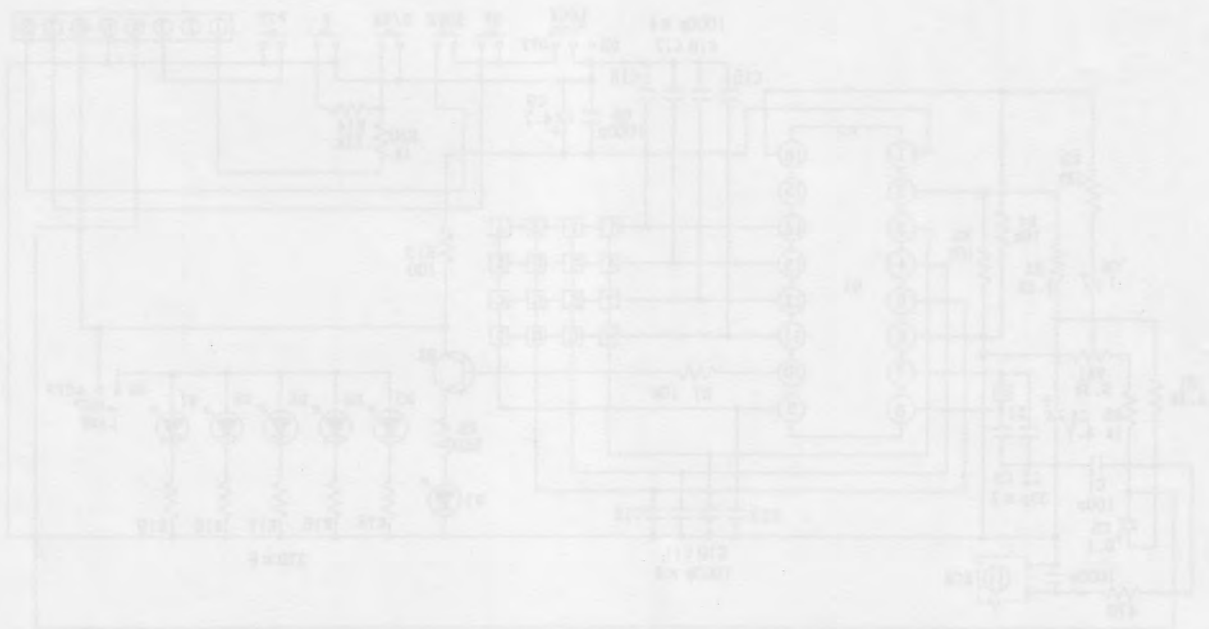

**YAESU**  
*Performance without compromise.<sup>SM</sup>*

Copyright © 1994  
Yaesu Musen Co., Ltd.  
All right reserved.

No portion of this manual  
may be reproduced  
without the permission of  
Yaesu Musen Co., Ltd.

Printed in Japan.

E06519000 (408o-AY)