



OPERATING AND SERVICE MANUAL

IC-RP2210

VHF REPEATER



ICOM INCORPORATED

INTRODUCTION

The advanced **IC-RP2210 VHF REPEATER** from **ICOM** is a highly reliable, heavy-duty repeater built for Amateur radio communications.

This manual contains information relative to the operational, theoretical, physical, mechanical, and electrical characteristics of the **IC-RP2210**.

ASSISTANCE

To thoroughly understand the capabilities of the **IC-RP2210**, please study this manual carefully before attempting operation.

If you have additional questions regarding maintenance or the operation of the **IC-RP2210**, feel free to contact your nearest authorized **ICOM Dealer** or **ICOM Service Center**.

ORDERING PARTS

For the fastest service, supply all of the following information when ordering parts from your dealer or **ICOM Service Center**:

1. Equipment model and serial number (e.g., **IC-RP2210**, No. 0001)
2. Printed circuit board name and number (e.g., **LOGIC UNIT B-1638B**)
3. Schematic part identifier (e.g., **IC1**)
4. Part number and name (e.g., μ **PD80C35C**, **IC**)
5. Quantity required (e.g., 2pcs.)

UNPACKING

Accessories included with the **IC-RP2210**:

	Qty.
① Microphone (HM-4)	1
② AC cord	1
③ Microphone hook	1
④ Spare fuses for AC line (5A)	2
⑤ Spare fuses for DC line (10A)	2

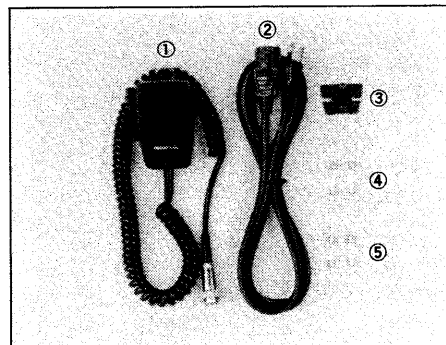

TABLE OF CONTENTS

<p>1. FEATURES 1-1</p> <p>2. SPECIFICATIONS 2-1</p> <p>3. CONTROL FUNCTIONS 3-1 ~ 3</p> <p>3-1 FRONT PANEL 3-2</p> <p>3-2 REAR PANEL 3-2</p> <p>4. INSTALLATION 4-1</p> <p>4-1 PLANNING 4-1</p> <p>4-2 ANTENNA SYSTEM 4-1</p> <p>4-3 DUPLEXER 4-1</p> <p>4-4 GROUNDING 4-1</p> <p>4-5 POWER SUPPLY 4-1</p> <p>5. GENERAL OPERATION 5-1 ~ 3</p> <p>5-1 INITIAL SETTINGS 5-1</p> <p>5-2 BASIC OPERATION 5-1</p> <p>5-3 FREQUENCY PROGRAMMING 5-2</p> <p>5-4 CTCSS FREQUENCY PROGRAMMING 5-3</p> <p>6. FUNCTIONS DESCRIPTION 6-1 ~ 4</p> <p>6-1 ID FUNCTION 6-1</p> <p>6-2 TIME-OUT TIMER FUNCTION 6-1</p> <p>6-3 HANG-UP TIMER FUNCTION 6-1</p> <p>6-4 MANUAL TRANSMIT FUNCTION 6-1</p> <p>6-5 REMOTE CONTROL FUNCTION 6-1</p> <p>7. CIRCUIT DESCRIPTION 7-1 ~ 6</p> <p>7-1 SYSTEM CONFIGURATION 7-1</p> <p>7-2 RECEIVER CIRCUIT 7-1</p> <p>7-3 TRANSMITTER CIRCUIT 7-2</p> <p>7-4 RECEIVER PLL CIRCUIT 7-3</p> <p>7-5 TRANSMITTER PLL CIRCUIT 7-3</p> <p>7-6 CONTROL CIRCUIT 7-4</p> <p>7-7 CTCSS DECODER CIRCUIT 7-6</p> <p>7-8 N-CONTROL CIRCUIT 7-6</p> <p>7-9 DTMF DECODER CIRCUIT 7-6</p> <p>8. MAINTENANCE AND ADJUSTMENT 8-1 ~ 12</p> <p>8-1 MAINTENANCE 8-1</p> <p>8-2 PREPARATION BEFORE SERVICING 8-1</p> <p>8-3 INSIDE VIEWS 8-2</p> <p>8-4 RECEIVER PLL ADJUSTMENT 8-3</p> <p>8-5 TRANSMITTER PLL ADJUSTMENT 8-5</p> <p>8-6 RECEIVER ADJUSTMENT 8-7</p> <p>8-7 TRANSMITTER ADJUSTMENT 8-9</p> <p>8-8 LOGIC AND REGULATOR ADJUSTMENT 8-11</p>	<p>9. BOARD LAYOUTS 9-1 ~ 4</p> <p>9-1 RX UNIT 9-1</p> <p>9-2 TX UNIT 9-2</p> <p>9-3 RX-VCO AND TX-VCO UNITS 9-3</p> <p>9-4 N-CTRL UNIT 9-3</p> <p>9-5 REGULATOR UNIT 9-3</p> <p>9-6 AF UNIT 9-3</p> <p>9-7 PA UNIT 9-3</p> <p>9-8 LOGIC UNIT 9-4</p> <p>10. UNIT INTERCONNECTIONS DIAGRAM 10-1</p> <p>11. BLOCK DIAGRAM 11-1</p> <p>12. PARTS LIST 12-1 ~ 12</p> <p>12-1 RX UNIT 12-1</p> <p>12-2 TX UNIT 12-3</p> <p>12-3 RX-VCO UNIT 12-5</p> <p>12-4 TX-VCO UNIT 12-6</p> <p>12-5 LOGIC UNIT 12-6</p> <p>12-6 N-CTRL UNIT 12-8</p> <p>12-7 PA UNIT 12-9</p> <p>12-8 FILTER UNIT 12-9</p> <p>12-9 AF UNIT 12-10</p> <p>12-10 REGULATOR UNIT 12-10</p> <p>12-11 FRONT UNIT 12-11</p> <p>12-12 MECHANICAL PARTS 12-12</p> <p>13. SCHEMATIC AND VOLTAGE DIAGRAM 13-1</p>
---	---

1. FEATURES

- Built-in high stability crystal unit for $\pm 5\text{ppm}$ to obtain steady transmit and receive output signals.
- Uses an external EPROM for programming an independent ID call sign for control functions, etc., and is adapted to user requirements.
- Components in the repeater's RF system are completely shielded in the RF shield case to prevent interference from other units.
- A heavy-duty, large heatsink is installed on the rear panel to ensure steady, continuous 24 hour operation.
- Housed in a durable steel frame to ensure long-term reliability.
- Uses a high performance 8-bit CPU, $\mu\text{PD80C35C}$, for controlling the repeater.
- The repeater has two-way, AC and DC power source capability. If AC power to the repeater is interrupted, DC power can be connected as a backup power source.
- The IC-RP2210 has convenient rack mounting adaptability. Just use the front panel screw holes and handles for easy installation in a cabinet or suitable location.



The product name shown in the picture differs from the actual repeater name.

The IC-RP2210 does not include the repeater metal cabinet as shown in the picture.

The cabinet is available as an option from ICOM. There is a space for installing a duplexer under the repeater body. The cabinet dimensions are 520mm(20.5'')W x 520mm(20.5'')H x 400mm(15.7'')D.

2. SPECIFICATIONS

■GENERAL

- Frequency coverage:
220 ~ 225MHz
- Number of channels:
1
- Modes:
F3 (16K0F3E)
- Repeater control system:
Carrier or Tone squelch operating system
- Power supply voltage:
AC 117V DC 13.8V
- Power consumption:
125W
- Usable temperature range:
-10°C ~ +60°C (+14°F ~ +140°F)
- Antenna impedance:
50Ω
- Frequency stability:
Less than ±0.0005% (±5ppm)
- Dimensions:
480(W) x 150(H) x 400(D)mm
18.9"(W) x 5.9"(H) x 15.7"(D)
- Weight:
19.0kg (41.9lbs)

■TRANSMITTER

- RF output power:
25W
- Modulation system:
Variable reactance frequency modulation
- Max. frequency deviation:
±5kHz
- S/N ratio:
More than 40dB for 70% modulation at 1000Hz
- Spurious emissions:
Less than -60dB below carrier output power
- Occupied bandwidth:
Less than 16kHz

■RECEIVER

- Receiver system:
Double-conversion superheterodyne
- Intermediate frequencies:
1st IF 21.8MHz 2nd IF 455kHz
- Sensitivity:
Less than 0.32μV (-117dBm) for 12dB SINAD
- Squelch sensitivity:
Less than 0.2μV
- Selectivity:
Less than 25kHz at -60dB
- Spurious response rejection ratio:
More than 60dB
- Desensitization:
More than 70dB
- Intermodulation response:
More than 60dB
- AF output power:
1.7W at 10% distortion with an 8Ω load

■LOGIC UNIT

- Tone decoder (CTCSS)
 - Frequency:
88.5Hz ±0.5% (other frequencies available)
 - Sensitivity:
Less than 6dB SINAD
 - Response time:
250msec. or less
- Control function
 - Hang-up time:
Within 5sec. (selectable)
 - ID sending speed:
3wpm to 20wpm with 800Hz tone
 - ID interval time:
First transmission after 2 to 3min. transmission
 - Remote control system:
DTMF control

3. CONTROL FUNCTIONS

FRONT PANEL

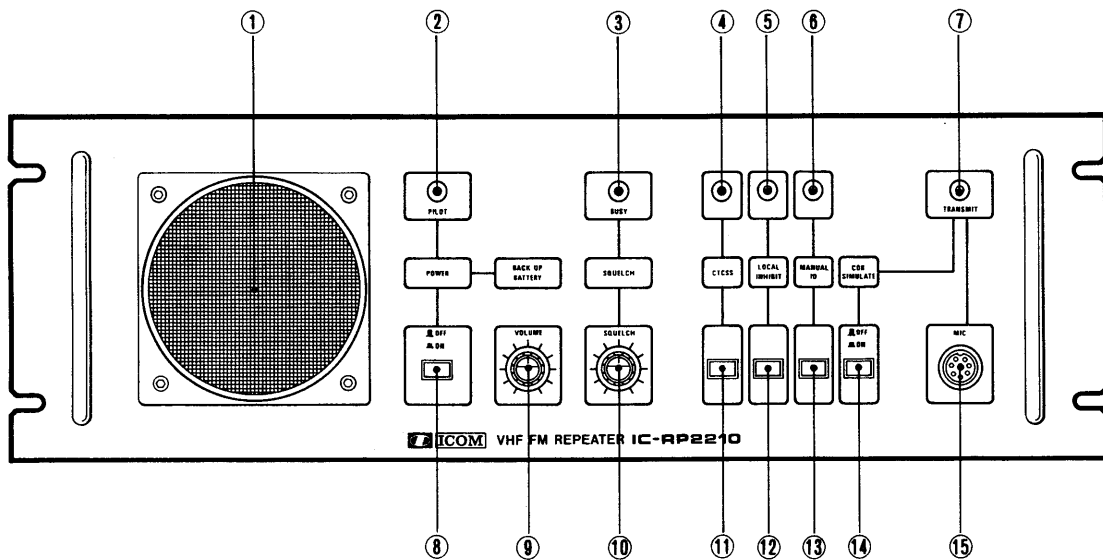

- | | |
|---------------------------|------------------------|
| ① INTERNAL SPEAKER | ⑨ VOLUME CONTROL |
| ② PILOT INDICATOR | ⑩ SQUELCH CONTROL |
| ③ BUSY INDICATOR | ⑪ CTCSS SWITCH |
| ④ CTCSS INDICATOR | ⑫ LOCAL INHIBIT SWITCH |
| ⑤ LOCAL INHIBIT INDICATOR | ⑬ MANUAL ID SWITCH |
| ⑥ MANUAL ID INDICATOR | ⑭ COR SIMULATE SWITCH |
| ⑦ TRANSMIT INDICATOR | ⑮ MIC CONNECTOR |
| ⑧ POWER SWITCH | |

REAR PANEL

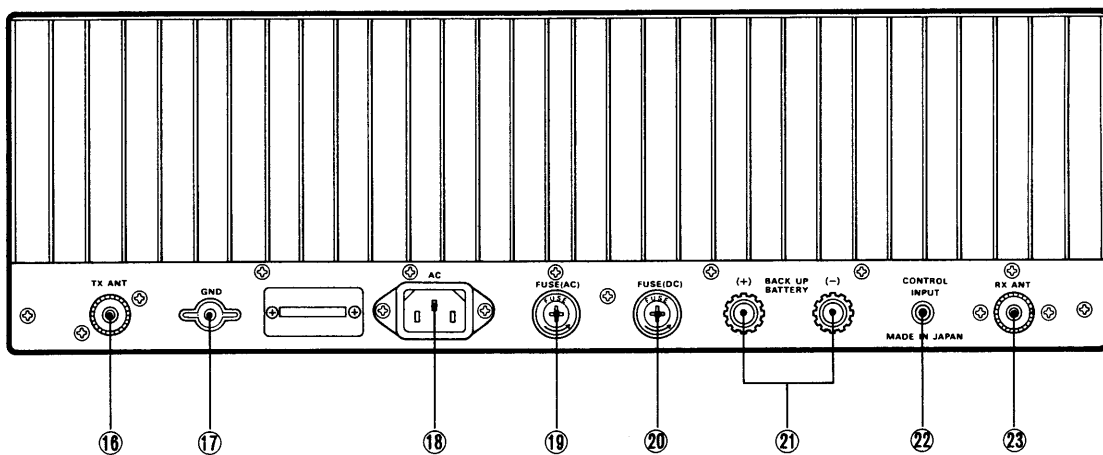

- | | |
|-------------------------------|-------------------------------|
| ①⑥ TRANSMIT ANTENNA CONNECTOR | ②⑩ DC LINE FUSE HOLDER |
| ①⑦ GROUND TERMINAL | ②① DC POWER INPUT TERMINALS |
| ①⑧ AC POWER SOCKET | ②② CONTROL SIGNAL INPUT JACK |
| ①⑨ AC LINE FUSE HOLDER | ②③ RECEIVER ANTENNA CONNECTOR |

3-1 FRONT PANEL

① INTERNAL SPEAKER

This speaker is used for monitoring received signals. (See item ⑨)

② PILOT INDICATOR

This indicator lights up when the POWER SWITCH is pushed IN.

- In AC operation : Lights up in yellow
- In DC operation : Lights up in red

③ BUSY INDICATOR

This indicator lights up when the repeater squelch is open. (See item ⑩)

④ CTCSS INDICATOR

This indicator lights up when the TONE SQUELCH FUNCTION is ON. (See item ⑪)

⑤ LOCAL INHIBIT INDICATOR

This indicator lights up when the LOCAL INHIBIT FUNCTION is ON. (See item ⑫)

⑥ MANUAL ID INDICATOR

This indicator lights up while the ID signal is being transmitted. (See item ⑬)

⑦ TRANSMIT INDICATOR

This indicator lights up when the repeater is transmitting. (See items ⑭ and ⑮)

⑧ POWER SWITCH

This switch turns the repeater ON and OFF. (See item ②)

⑨ VOLUME CONTROL

This control varies the audio output level from the INTERNAL SPEAKER. Clockwise rotation increases the level.

⑩ SQUELCH CONTROL

This control sets the squelch threshold level for receive signals. Clockwise rotation increases the squelch threshold level. (See item ③)

⑪ CTCSS (Continuous Tone Controlled Squelch System) SWITCH

This switch turns the TONE SQUELCH FUNCTION ON and OFF alternately and can be remote-controlled. (See item ④).

OFF condition:

The CTCSS INDICATOR does not light up. The repeater functions as an open repeater that transmits all received signals regardless of subaudible tones.

ON condition:

The CTCSS INDICATOR lights up. The repeater is set in CTCSS operation and opens when a signal with a specified subaudible tone superimposed on it is received, and transmits signals carrying the specified subaudible tone.

⑫ LOCAL INHIBIT SWITCH

This switch turns the repeater status alternately ON and OFF and can be remote-controlled. (See item ⑤)

OFF condition:

The LOCAL INHIBIT INDICATOR does not light up. The repeater functions as an ordinary repeater.

ON condition:

The LOCAL INHIBIT INDICATOR lights up. The repeater functions as an ordinary transceiver.

⑬ MANUAL ID (Identifier) SWITCH

This switch allows an identifier signal to be sent manually. Each push of the switch sends an ID signal. The MANUAL ID INDICATOR lights up while sending the ID out. (See item ⑥)

⑭ COR (Carrier Operated Relay) SIMULATE SWITCH

This switch sets the repeater in transmit mode continuously, and can be used for checking repeater functions such as hang-up time, time-out timer, etc. (See item ⑦)

⑮ MIC CONNECTOR

Connects the supplied HM-4 MICROPHONE.

When the [LOCAL INHIBIT] SWITCH is OFF:

Microphone signals are superimposed on receive signals when the PTT SWITCH is pushed.

When the [LOCAL INHIBIT] SWITCH is ON:

The PTT SWITCH on the microphone is pushed IN and the repeater functions as an ordinary transceiver when the microphone is used.

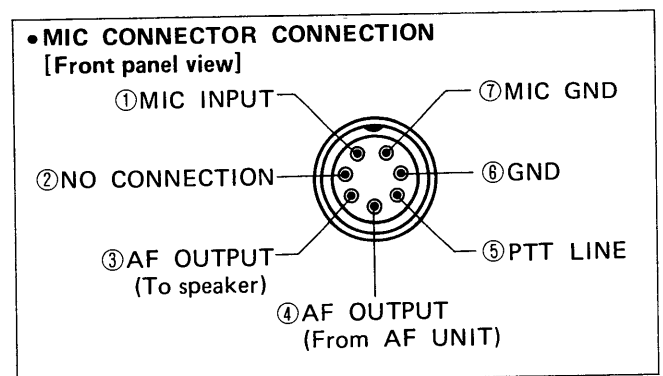

3-2 REAR PANEL

⑯ TRANSMIT ANTENNA CONNECTOR

This connector outputs RF output power. Connect a coaxial cable between the connector and the transmitter connector of the duplexer.

⑰ GROUND TERMINAL

Connect a ground cable to this terminal. Be sure to ground the repeater to a good earth point to protect the repeater and prevent electrical shocks.

18 AC POWER SOCKET

The AC POWER SOCKET connects the repeater to an AC outlet via the supplied AC cord.

19 AC LINE FUSE HOLDER

This holder contains the 5A fuse for the AC power supply. Use the spare fuses provided to replace an old or damaged fuse.

20 DC LINE FUSE HOLDER

This holder contains the 10A fuse for the DC power supply. Use the spare fuses provided to replace an old or damaged fuse.

21 DC POWER INPUT TERMINALS

Connects a DC power source such as a 12V-type storage battery for DC operation. This battery is used for the repeater backup battery when power is interrupted during AC operation. See p. 4 - 1 for information regarding use of these terminals.

22 CONTROL SIGNAL INPUT JACK

This jack is used for controlling repeater functions such as CTCSS or LOCAL INHIBIT by DTMF tones from external equipment.

23 RECEIVER ANTENNA CONNECTOR

This connector receives incoming signals from the antenna sent through the duplexer. Connect a coaxial cable between this connector and the receive connector on the duplexer.

4. INSTALLATION

4-1 PLANNING

This repeater should be installed in a cabinet to protect it from dust, moisture, etc. The repeater has four screw holes and two handles on each side of the front panel for this installation purpose.

- **AVOID** using the IC-RP2210 in the following situations:
 - Where temperatures under -10°C or over $+60^{\circ}\text{C}$ are encountered. **DO NOT** use the repeater in areas exposed to direct sunlight for long periods.
 - In places subject to rain, humidity, strong winds, or excessive dust and moisture.
- To facilitate good ventilation and emergency maintenance, allow sufficient access between the repeater and the surrounding walls.

4-2 ANTENNA SYSTEM

CAUTION: Transmitting without an antenna may damage the transmitter of the repeater.

(1) ANTENNA

Antenna performance is important for reliable radio communications. For this reason, a 50Ω directional antenna is well worth the extra investment. Many high quality fixed location antennas are available from various manufacturers. Choose one most suited to your needs.

- Use heavy-duty stainless steel mounting hardware to protect the antenna from bad weather and preserve it for longer periods of time.

(2) COAXIAL CABLE

We recommend using a coaxial cable as follows, particularly in a fixed location installation of a repeater where feed lengths are very long:

- Use a thick, low loss, all weather-type coaxial cable, and for best results make the connection between the antenna and repeater as short as possible.

4-3 DUPLEXER

This repeater does not include a duplexer. The duplexer must be purchased separately.

- The cables between the repeater and duplexer should be as short and thick as possible to reduce insertion loss.

4-4 GROUNDING

To prevent electrical shocks, interference to other stations, and other problems, be sure to ground the repeater through the **GROUND TERMINAL**.

- To ensure safety, use the heaviest gauge wire or strap available and make the connection as short as possible.
- **NEVER** use a gas pipe or electrical conduit pipe for grounding.

4-5 POWER SUPPLY

The IC-RP2210 can function with either an AC or DC power source. If AC power is interrupted when operating the repeater with an AC power source, power is automatically provided to the repeater when a 12V-type storage battery is connected to the **DC POWER INPUT TERMINALS** on the rear panel.

(1) IN AC OPERATION

- Extension cords should not be used unless absolutely necessary. Use of improper extension cords could result in fire risk.
- Use a proper power source from an AC outlet.

(2) IN DC OPERATION

CAUTION: Voltages greater than 16V DC will damage your repeater. Check the source voltage before connecting the power cable.

- Connect a battery with sufficient capacity such as a lead-acid battery. The current drain is approx. 8A while transmitting.
- Place the battery in a spot away from the repeater as gas leakage from the battery could cause corrosion when a lead-acid battery is used. Keep the battery cable long and install the battery more than 5 meters away from the repeater. Provide good ventilation.
- Charge the battery completely before connecting it to the repeater. Note the polarity: positive wire to the **RED** terminal; negative wire to the **BLACK** terminal.
- During AC operation a current of 100mA is fed from the repeater to recharge the battery as long as the repeater **POWER SWITCH** is **ON**. This is enough current to compensate for the battery's natural discharge. However, recharge the battery using an external charger.

5. GENERAL OPERATION

5-1 INITIAL SETTINGS

After all installation instructions have been followed in Section 3, set the controls and switches as shown in the diagram.

- 1) Make sure the [POWER] SWITCH is OFF, then plug the AC cord into a domestic AC outlet for AC operation, or apply 12V DC to the DC POWER TERMINALS for DC operation.
- 2) An antenna must be connected to the repeater through a duplexer. (See p. 4 - 1)

CAUTION: Transmitting without an antenna may damage the transmitter of the repeater.

- 3) A ground connection must be made through the GROUND TERMINAL. (See p. 4 - 1)
- 4) Connect the supplied HM-4 MICROPHONE to the MIC CONNECTOR.

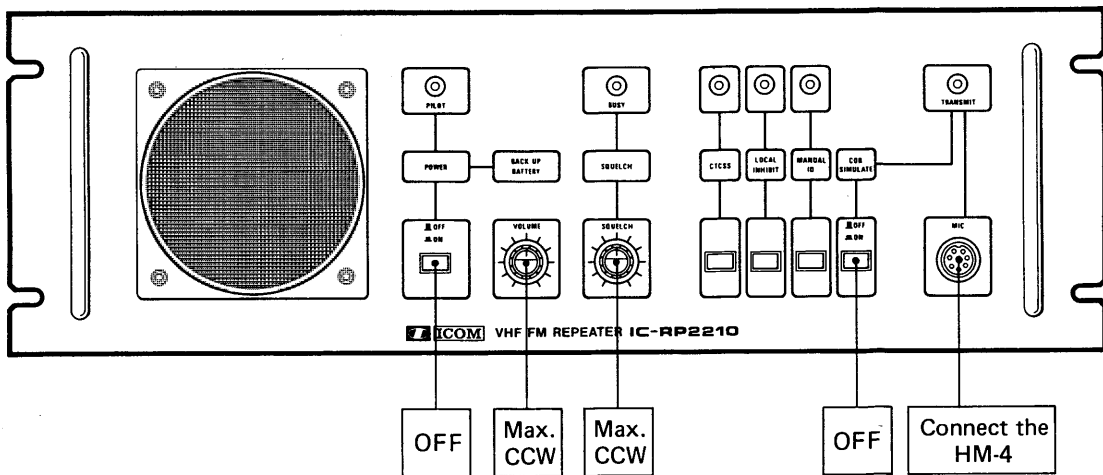

5-2 BASIC OPERATION

- 1) Push the POWER SWITCH ON (IN).

The following indicators should light up.

INDICATOR	LIGHT
[PILOT]	Lights up yellow*
[BUSY]	Lights up green
[LOCAL INHIBIT]	Lights up green

* The PILOT INDICATOR should light up yellow when the repeater is operating with an AC power source, and red when operating with a DC power source.

- 2) Rotate the [VOLUME] CONTROL clockwise to a suitable audio level if needed.
- 3) Rotate the [SQUELCH] CONTROL clockwise until noise from the speaker is quieted. The [BUSY] INDICATOR goes out.

- 4) Set repeater mode for either a private or open repeater.

For private repeaters:

Push the [CTCSS] SWITCH ON. The green [CTCSS] INDICATOR lights up and the repeater transmits only received signals with specified subaudible tones superimposed on them.

For open repeaters:

Push the [CTCSS] SWITCH to turn OFF the TONE SQUELCH FUNCTION if the [CTCSS] INDICATOR lights up. The [CTCSS] INDICATOR does not light up and the repeater transmits all received signals.

- 5) Push the [LOCAL INHIBIT] SWITCH to turn OFF the repeater. The yellow [LOCAL INHIBIT] INDICATOR goes out.

5-3 FREQUENCY PROGRAMMING

Both the receive and transmit frequencies can be set independently by dip switches on the N-CTRL UNIT. See p. 7 - 6 for detailed circuit description information and the diagram below for the N-CTRL UNIT location.

Following are the methods for programming both the receive and transmit frequencies.

WARNING TO PREVENT ELECTRIC SHOCKS, DISCONNECT ANY POWER CORD FROM THE REPEATER BEFORE PERFORMING WORK ON THE REPEATER.

• BOTTOM VIEW

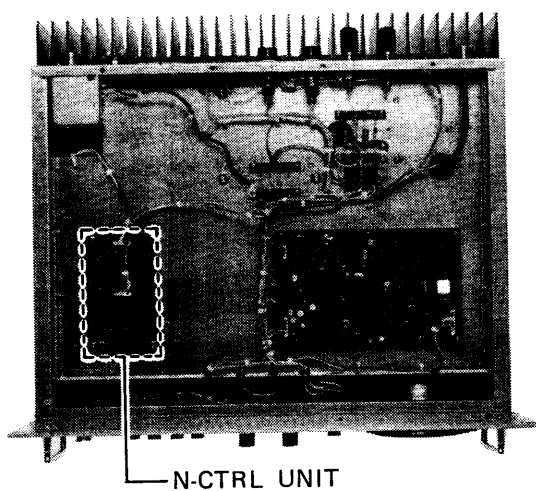

- 1) Remove the bottom cover from the repeater.
- 2) Calculate a value of N-data using the following formula. The values are different depending on the repeater's channel spacing.

• RECEIVE FREQUENCY:

$$\text{N-data} = \frac{\text{Receive frequency} - \text{1st IF}}{\text{Channel spacing}}$$

• TRANSMIT FREQUENCY:

$$\text{N-data} = \frac{\text{Transmit frequency}}{\text{Channel spacing}}$$

- 3) Set dip switches using the value of the N-data got from the above formula.

Each dip switch has an independent N-data value. Set switches according to each value.

- 4) Check the dip switch setting before replacing the cover and trying to open the repeater.

• N-CTRL UNIT

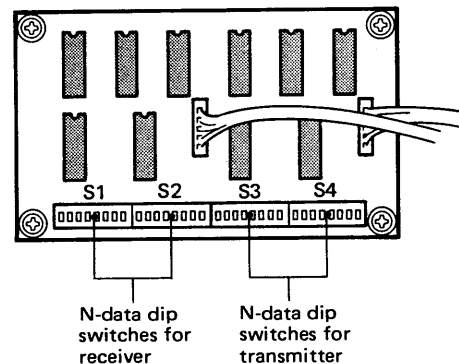

■ EXAMPLE SETTING (RECEIVE)

Receive frequency : 220.00MHz
 1st IF : 21.8MHz
 Channel spacing : 5kHz (0.005MHz)

$$\begin{aligned} 1) \text{ N-data} &= \frac{\text{Receive frequency} - \text{1st IF}}{\text{Channel Spacing}} \\ &= \frac{220.00 - 21.8}{0.005} \\ &= 39640 \end{aligned}$$

- 2) Set dip switches in the ON position according to their calculated N-data values.

- 3) The following dip switches should be ON:

Dip switches	N-data value
S2-8	→ 32768
S2-5	→ 4096
S2-4	→ 2048
S2-2	→ 512
S1-8	→ 128
S1-7	→ 64
S1-5	→ 16
S1-4	→ 8 (+)
Total	39640

• DIP SWITCH SETTINGS

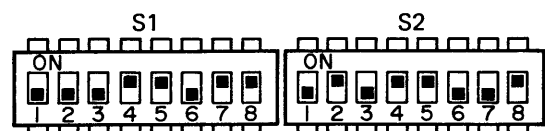

NOTE: Black areas indicate switch positions.

EXAMPLE SETTING (TRANSMIT)

Transmit frequency : 225.00MHz
 Channel spacing : 5kHz (0.005MHz)

$$1) \text{ N-data} = \frac{\text{Transmit frequency}}{\text{Channel Spacing}}$$

$$= \frac{225.00}{0.005}$$

$$= 45000$$

2) Set dip switches in the ON position according to their calculated N-data values.

The following dip switches should be ON:

Dip switches	N-data value
S4-8	→ 32768
S4-6	→ 8192
S4-4	→ 2048
S4-3	→ 1024
S4-2	→ 512
S4-1	→ 256
S3-8	→ 128
S3-7	→ 64
S3-4	→ 8 (+)
Total	45000

DIP SWITCH SETTINGS

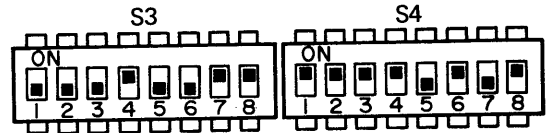

NOTE: Black areas indicate switch positions.

5-4 CTCSS FREQUENCY PROGRAMMING

One of 37 kinds of CTCSS decoder frequencies can be set by the S2 dip switches on the LOGIC UNIT. See the diagram below for S2 Switch locations.

Use the S2-7 and S2-8 dip switches for fine tuning of CTCSS decoder frequency. See diagram below.

LOGIC UNIT

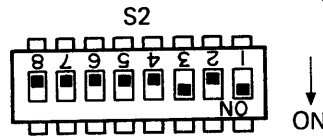
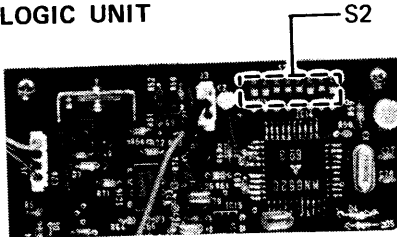

• Example: If the S2-7 and S2-8 dip switches are set in the ON position, and the other switches are set as shown in the figure below, the CTCSS decoder frequency is approximately:

$$88.5 \times (1 + 0.015) = 89.8[\text{Hz}]$$

TONE FREQ [Hz]	SWITCHES						TONE FREQ [Hz]	SWITCHES						TONE FREQ [Hz]	SWITCHES					
	1	2	3	4	5	6		1	2	3	4	5	6		1	2	3	4	5	6
67.0	1	0	0	0	0	0	110.9	0	1	0	1	0	0	173.8	1	1	1	0	1	0
71.9	0	1	0	0	0	0	114.8	1	1	0	1	0	0	179.9	0	0	0	1	1	0
74.4	0	0	1	0	0	1	118.8	0	0	1	1	0	0	186.2	1	0	0	1	1	0
77.0	1	1	0	0	0	0	123.0	1	0	1	1	0	0	192.8	0	1	0	1	1	0
79.7	0	1	1	0	0	1	127.3	0	1	1	1	0	0	203.5	1	1	0	1	1	0
82.5	0	0	1	0	0	0	131.8	1	1	1	1	0	0	210.7	0	0	1	1	1	0
85.4	0	0	0	1	0	1	136.5	0	0	0	0	1	0	218.1	1	0	1	1	1	0
88.5	1	0	1	0	0	0	141.3	1	0	0	0	1	0	225.7	0	1	1	1	1	0
91.5	0	1	0	1	0	1	146.2	0	1	0	0	1	0	233.6	1	1	1	1	1	0
94.8	0	1	1	0	0	0	151.4	1	1	0	0	1	0	241.8	0	0	0	0	0	1
100.0	1	1	1	0	0	0	156.7	0	0	1	0	1	0	250.3	1	0	0	0	0	1
103.5	0	0	0	1	0	0	162.2	1	0	1	0	1	0	—	—	—	—	—	—	—
107.2	1	0	0	1	0	0	167.9	0	1	1	0	1	0	—	—	—	—	—	—	—

0 : OFF
 1 : ON

FINE TUNING [%]	SWITCHES	
	7	8
+1.5	1	1
+1.0	1	0
+0.5	0	1
0	0	0

0 : OFF
 1 : ON

6. FUNCTIONS DESCRIPTION

6-1 ID FUNCTION

The ID FUNCTION allows you to transmit an ID call sign for the repeater manually or automatically. The type of signal is CW (F2), and is sent out as described below.

(1) MANUAL ID FUNCTION

The ID call signal is sent out each time you push the [MANUAL ID] SWITCH on the front panel.

(2) AUTOMATIC ID FUNCTION

- The ID call sign is sent out when an incoming signal switches the repeater from standby condition to the transmit mode.

- An ID call sign is sent out approx. every 3 minutes.

6-2 TIME-OUT TIMER FUNCTION

This function prevents the repeater from being occupied by a station for a long time.

If the access exceeds the preset time limit (approx. 3 minutes) the repeater shuts down automatically for 5 seconds.

If the access is still "ON" after 5 seconds, the repeater sends an ID call sign.

6-3 HANG-UP TIMER FUNCTION

The repeater is designed to retain the "transmit" condition for 5 seconds after an incoming signal is stopped.

If there is an access during this period of 5 seconds, the transmit operation starts immediately. The repeater is thus prevented from turning OFF during short pauses when stations are using the repeater.

This hang-up time can be changed by switches S1-1 and S1-2 on the LOGIC UNIT as shown below.

SET TIME	SWITCH POSITION	
	S1-1	S1-2
0sec.	ON	ON
1sec.	ON	OFF
3sec.	OFF	ON
5sec.	OFF	ON

6-4 MANUAL TRANSMIT FUNCTION

(1) INTERRUPT TRANSMIT FUNCTION

Push the PTT SWITCH on the microphone and speak into the microphone. Voice signals from the microphone are transmitted even if an incoming signal has accessed the repeater.

(2) FUNCTIONING AS AN ORDINARY TRANSCEIVER

Push the [LOCAL INHIBIT] SWITCH to turn ON the LOCAL INHIBIT FUNCTION. The [LOCAL INHIBIT] INDICATOR lights up green and the repeater functions as an ordinary transceiver.

Push the PTT SWITCH on the microphone to activate transmit mode; release the PTT SWITCH to activate receive mode.

6-5 REMOTE CONTROL FUNCTION

The IC-RP2210 repeater can be remote-controlled by the built-in DTMF decoder. This decoder employs 4-digit sequential signals as a control signal to prevent accidental control. The following functions can be remote-controlled.

- LOCAL INHIBIT MODE ON and OFF.
- TONE SQUELCH MODE ON and OFF.

(1) REMOTE-CONTROLLING THE REPEATER

1) Send a specified code consisting of 4 DTMF tones from a remote controller such as your transceiver keyboard to turn ON or OFF a function as shown in the table below.

(Example)

Push keys [A], [1], [2] and [6] on the DTMF keyboard and the TONE SQUELCH FUNCTION of the repeater turns ON.

2) The DTMF decoder is set at the factory as shown below. However, the decoder can be re-set to your own code. (See p. 6 - 2).

FUNCTIONS	KEY ENTRY (Specified code)
LOCAL INHIBIT ON	[A] [1] [2] [3]
LOCAL INHIBIT OFF	[A] [1] [2] [4]
TONE SQUELCH OFF	[A] [1] [2] [5]
TONE SQUELCH ON	[A] [1] [2] [6]

Factory default

(2) Programming the control number

A specified code consisting of 4 DTMF tones for the remote controller can be changed as follows:

- 1) Select the desired function you want to change from the list shown above.
- 2) Set a control code consisting of 4 digits. The first 3 digits of the code must be used for the other remote control functions. The last digit is used for each corresponding function. (See the table at right)

NOTE: Two functions can be remote-controlled using 4 different control codes. However, **REMEMBER** that the first 3 digits of 4 different codes must be the same. Only the last digit can be different.

- 3) Unscrew the 6 screws on the LOGIC UNIT and lift up the unit.
- 4) Unsolder and disconnect jumper wires W1 (brown) through W6 (blue) and W9 (white) from the programming area on the unit.

- 5) Insert the W9 (white) jumper wire to the hole of the first digit selected and solder it from the bottom of the unit.
- 6) Insert the W1 (brown) and W2 (red) jumper wires to the hole of the second and third digits selected and solder them from the foil side of the unit.
- 7) Insert a jumper wire among the remaining wires W3 (orange) through W6 (blue) to the hole of the last digit and solder it. W3 through W6 have the following corresponding functions:

JUMPER WIRE	FUNCTION
W3 (orange)	LOCAL INHIBIT OFF
W4 (yellow)	LOCAL INHIBIT ON
W5 (green)	TONE SQUELCH OFF
W6 (blue)	TONE SQUELCH ON

- 8) There are 3 more jumper wires left without wiring. These wires correspond to the functions shown below in the above table. Connect wires in the same manner as described in the wiring method above.

■ REMOTE CONTROL SETTING EXAMPLE

The following are examples for programming remote control codes. Programming should be made on the LOGIC UNIT which is located on the bottom side of the repeater. (See p. 8 - 2 for the exact location.)

- (1) Programming code [#] [1] [2] [0] for the LOCAL INHIBIT ON function.

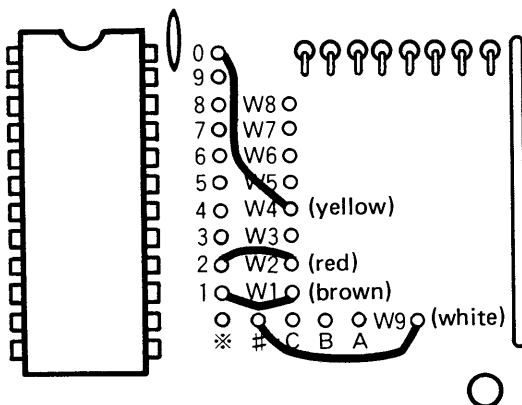

- (2) Programming code [1] [2] [3] [0] for the TONE SQUELCH ON function.

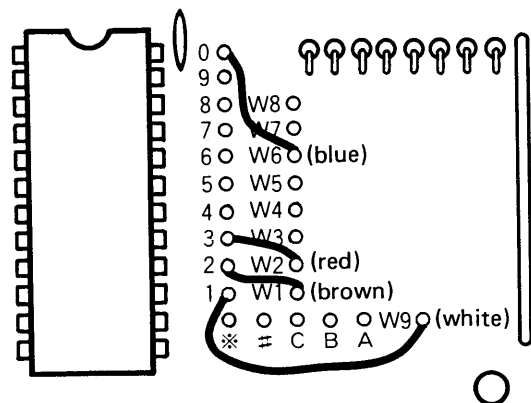

*The first three codes must be the same for the LOCAL INHIBIT OFF, TONE SQUELCH OFF, and TONE SQUELCH ON functions.

*The first three codes must be the same for the LOCAL INHIBIT ON, LOCAL INHIBIT OFF, and TONE SQUELCH OFF functions.

■ TIMING CHARTS OF TRANSMITTING AND ID EMISSIONS

The functions listed below are represented in the diagrams by their assigned letters.

- Ⓐ Hang-up timer : Selectable to 0, 1, 3 and 5 seconds with S1 switch.
- Ⓑ Time-out timer : 3 minutes
- Ⓒ Repeater stop timer : 5 seconds
- Ⓓ Basic communication timer : 2 minutes

(1) If one station occupies the repeater for more than 3 minutes.

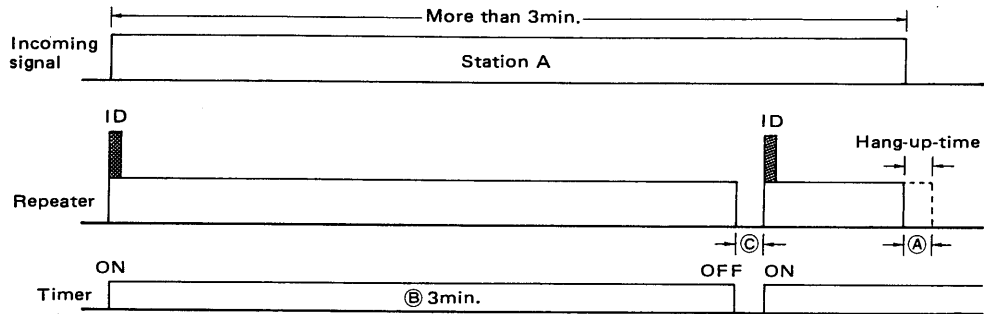

(2) If two stations communicate with each other for more than 3 minutes without an interruption of 5 seconds or more:

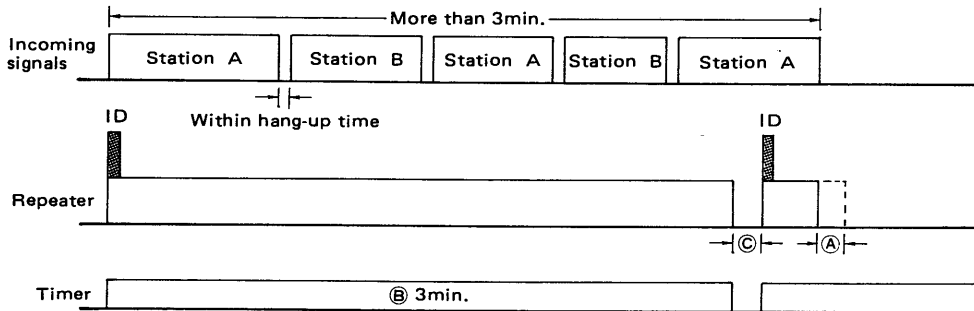

(3) If communication between two stations is completed between 2 and 3 minutes and then a third station uses the repeater:

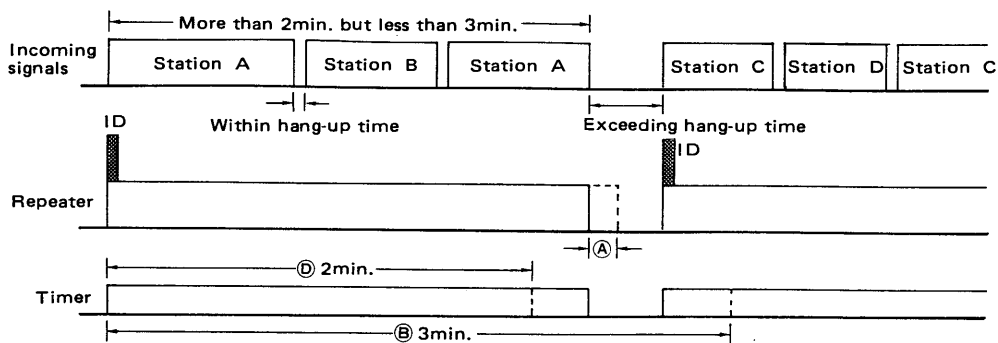

(4) If communication between two stations is completed within 2 minutes, and then other stations use the repeater:

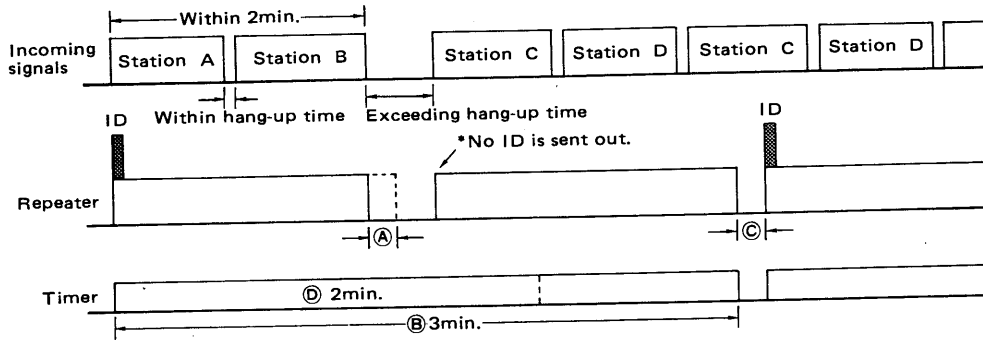

*In cases (1) through (4) above, the timers and ID sending interval are shown as default settings. By replacing the EPROM, it is possible to change their functions as shown below.

(5) If communication between two stations is completed within 3 minutes, the timer is OFF, and the moment there is an access from a third station, an ID signal is sent and at the same time the timer is reset. If the first communication duration exceeds 3 minutes, the case is the same as (1) or (2).

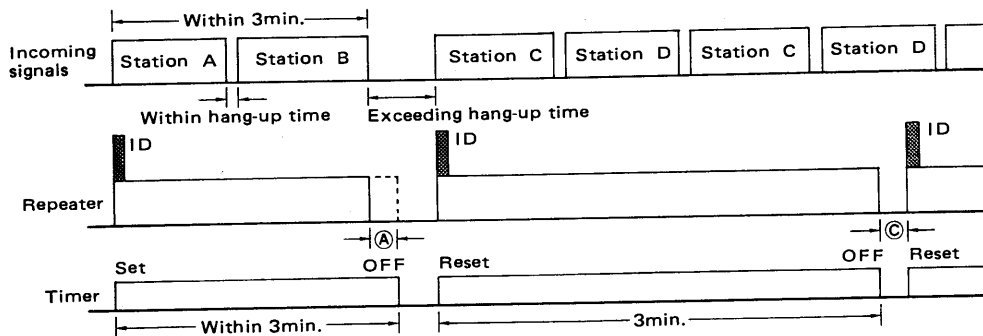

* ID sending speed is 20wpm with this system.

7. CIRCUIT DESCRIPTION

7-1 SYSTEM CONFIGURATION

The IC-RP2210 consists of the following circuits:

- ① RECEIVER CIRCUIT
- ② TRANSMITTER CIRCUIT
- ③ PLL CIRCUIT
- ④ N-DATA CONTROL CIRCUIT
- ⑤ CONTROL CIRCUIT
- ⑥ DECODER CIRCUIT
- ⑦ POWER SUPPLY CIRCUIT

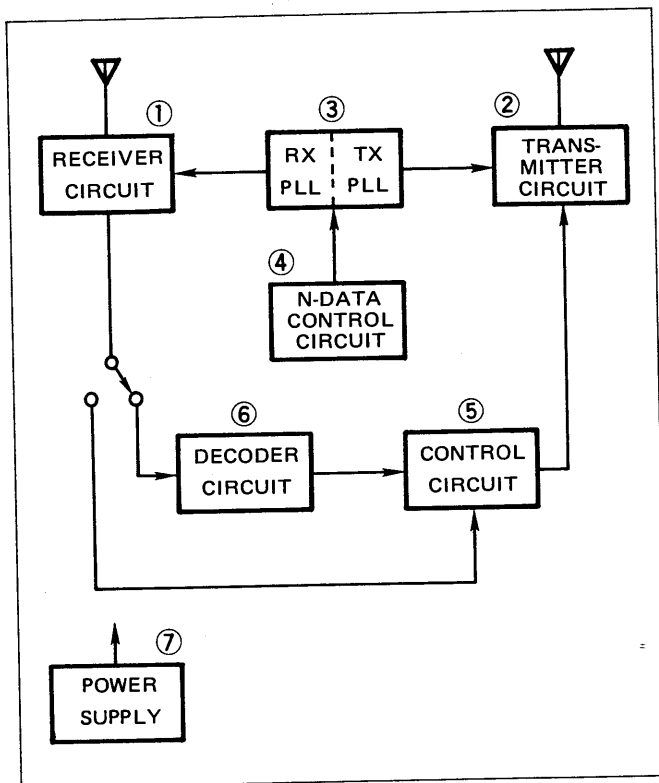

7-2 RECEIVER CIRCUIT

The receiver unit employs a PLL-controlled, double-conversion superheterodyne with 1st IF signals of 21.8MHz and 2nd IF signals of 455kHz. The unit housing is shielded to prevent interference. A BNC connector and feedthrough capacitors are also used for reducing RF loss and interference.

(1) RF CIRCUIT (RX UNIT)

Incoming signals fed from J1 are passed through a bandpass filter consisting of varicaps D1 ~ D4 and pattern coils to eliminate unwanted signals from the band. Signals passed through the bandpass filter are amplified by Q1 (3SK121) for high-gain and low-noise amplification.

Signals amplified by Q1 pass through a bandpass filter consisting of varicaps D5 ~ D12 and pattern coils, then enter the 1st gate of 1st mixer Q2 (3SK121). The local oscillator output from the PLL circuit is injected into the 2nd gate of this FET. The output signals are mixed with this signal and converted to 1st IF (21.8MHz) signals.

The center frequency of the BPFs is shifted as capacitance of varicaps (D1 ~ D12) and is varied by the control voltage from the RX-VCO UNIT.

(2) IF CIRCUIT (RX UNIT)

1st IF signals converted to 21.8MHz are turned into a necessary band by the crystal filter of F11 and then amplified by the IF amplifier of Q3 (3SK122). The amplified signals are applied to IC1 through the matching transformer of L6.

IC1 is an IC chip for FM-IF. The amplifier for the 2nd local oscillator, the 2nd mixer, the limiter amplifier, the quadrature detector, and the active filter are collected in one package.

Signals entered at pin 16 of IC1 are mixed with a 2nd local oscillator consisting of C26, C27 and crystal unit X1 (21.345MHz), and are output from pin 3 as 2nd IF signals of 455kHz. The signals pass through a high-performance ceramic filter of F12, enter pin 5, and are detected by the limiter amplifier. A phase delay element (X2) is used in the detection circuit to improve temperature characteristics.

Detected AF signals are output from pin 9. The signals pass through a deemphasis circuit consisting of R32 and C43, then through the AF circuit. Output signals from pin 9 are also applied to the squelch circuit and the tone squelch circuit.

(3) SQUELCH CIRCUIT (RX UNIT)

IC2(b) functions as an electronically controlled AF attenuator for control of a squelch threshold level, switching the AF signals for the squelch function.

For squelch control, signals are fed to pin 1 of IC2(b), pass through the AF attenuator, and are output from pin 3. Output signals from pin 3 are controlled logarithmically by the DC voltage from pin 13, and are applied to pin 10 of IC1. Noise components in the output signal are selected by the active filter of IC1.

Signals are rectified at D16, D17 and C36, and are then fed to DC amplifier Q4 in order to control the voltage at pin 6 of IC2(a).

The collector of Q4 is connected to the base of Q5 and turns ON and OFF the BUSY INDICATOR.

(4) AF CIRCUIT (RX AND AF UNITS)

Detected AF signals from pin 9 pass through a deemphasis circuit consisting of R32 and C43, are fed to pin 8 of IC2(a), and then are output from pin 10. These AF signals are turned ON and OFF by the squelch signal at pin 6.

AF signals from pin 10 of IC2(a) contain a subaudible tone signal to access repeaters. After removing subaudible tone signals by a BPF consisting of IC3, the signals are output from pin 1 and applied to the AF UNIT located behind the front panel.

IC1 on the AF UNIT amplifies low level AF signals from IC3 on the RX UNIT and drives an internal speaker.

(5) P2 CONNECTOR CONNECTIONS

PIN NUMBER	CONNECTION
Pin 1	Discriminator output
Pin 2	Ground
Pin 3	AF output
Pin 4	13.8V DC input
Pin 5	SQUELCH CONTROL input
Pin 6	BUSY INDICATOR output
Pin 7	Squelch switching signal output
Pin 8	No connection

7-3 TRANSMITTER CIRCUIT

(1) MIC AMP CIRCUIT (TX UNIT)

Audio signals from the microphone are applied to IC3(a) and IC3(b) through a preemphasis circuit consisting of C52 and R50, and are amplified. Components over 3kHz of the audio signal are eliminated from the splatter filter of IC4(a) and the expansion of unnecessary bands is inhibited. The signal enters the TX-VCO UNIT in the TX UNIT for generating an FM modulation signal.

(2) MODULATION CIRCUIT (TX-VCO UNIT)

The modulation signal is applied to the varicap, D5 and FM modulation is carried out as it enters the gate of Q1 through C4 in the direct modulation system.

(3) DRIVER AMPLIFIER CIRCUIT (TX UNIT)

Output signals from the TX-VCO UNIT are amplified by Q9 for the predriver, and then are amplified by a wide-band amplifier circuit consisting of Q10, Q11 and Q12. Signals then enter the PA UNIT.

VCO output signals are also applied to the transmitter PLL loop through an isolation circuit consisting of L1, R1 ~ R4 and R31 ~ R33.

(4) POWER AMPLIFIER CIRCUIT (PA UNIT)

The PA UNIT is located behind the rear panel heatsink, and is shielded by a metal case.

IC1 is an RF power module that can output 25W with an input of 200mW. Steady output power over a broad band can be continuously obtained since a large-sized heatsink is installed.

(5) LOW-PASS FILTER CIRCUIT (FILTER UNIT)

Spurious high harmonic emissions are fully suppressed by a 3-stage low-pass filter consisting of L2 ~ L4 and C14 ~ C20.

An SWR detector circuit is installed in the repeater. SWR is detected by D1 and D2 and detected voltage is used for the ALC control voltage.

(6) ALC CONTROL CIRCUIT (FILTER UNIT)

Voltage detected by D1 and D2 enters an inverter circuit consisting of IC1 (op-amp). The ALC control voltage is applied to Q1 on the PA UNIT through Q1 on the FILTER UNIT and P2 connector.

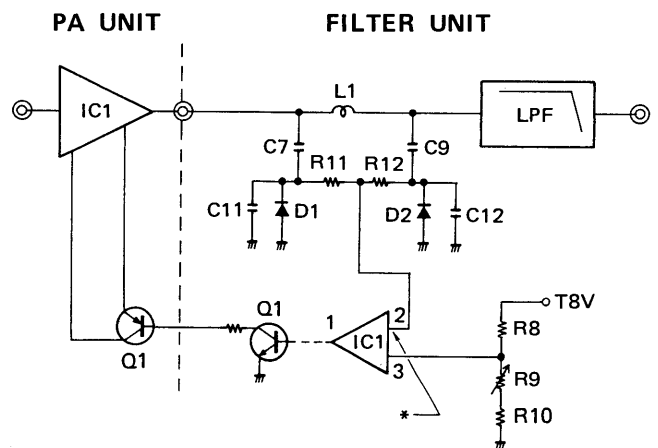

*When this voltage is higher than the voltage of pin 3, pin 1 becomes "LOW" and reduces output power in the PA UNIT.

(7) P10 CONNECTOR CONNECTIONS

PIN NUMBER	CONNECTION
Pin 1	Mic PTT output
Pin 2	PTT control output
Pin 3	13.8V DC input
Pin 4	T8 output
Pin 5	Ground
Pin 6	Connected to mic amp
Pin 7	Ground
Pin 8	Mic input

7-4 RECEIVER PLL CIRCUIT

Each receiver and transmitter circuit has an independent PLL circuit for controlling frequencies. Each PLL circuit is shielded and installed in the RX and TX UNIT.

(1) RECEIVER VCO CIRCUIT (RX-VCO UNIT)

The receiver VCO circuit (RX-VCO UNIT) utilizes a strip line and varicaps D1 ~ D4 for wide-band oscillation. A junction-type FET (Q1) performs the oscillation.

Oscillation output signals are buffer amplified at Q2 for improving C/N (Carrier-to-Noise ratio) characteristics.

(2) PLL CIRCUIT (RX UNIT)

VCO output signals are buffer amplified by Q7 and are divided by 1/64 and 1/65 by a dual modulus prescaler, IC5. In addition, divided signals are applied to IC4 and are divided by N-data from the N-CTRL UNIT.

IC4 includes a phase detector circuit. Divided signals are compared with the reference oscillator frequency. Detector signals are output from pins 12 and 13 on IC4.

Output signals are received at the charge pump circuit of Q8 and Q9 and are supplied with high DC voltage (+20V). By using this method, the PD (Phase Detector) voltage expands and the VCO covers a very wide frequency range. R68, R69, R70 and C82 make a LPF for the loop filter of this PLL circuit. D23 and D24 reduce lockup time.

N-data is the value obtained by dividing the object frequency by channel spacing as shown in the formula below.

$$N\text{-data} = \frac{\text{Receive frequency} - 1\text{st IF}}{\text{Channel spacing}}$$

(3) REFERENCE FREQUENCY OSCILLATOR CIRCUIT (RX UNIT)

The oscillator circuit consists of crystal unit X3, transistor Q6, thermistors R56 and R59, Varicap D21 and other parts. The oscillation circuit is made from a reference oscillation circuit which is highly stable within a wide temperature range. The reference oscillation is divided inside IC4 to obtain 5kHz.

A part of the frequency from pin 14 of IC4 enters a booster circuit consisting of Q12, D25, L12 and the other parts. The output voltage of Q12 is at a high voltage (+20V) and is used in the charge pump circuit.

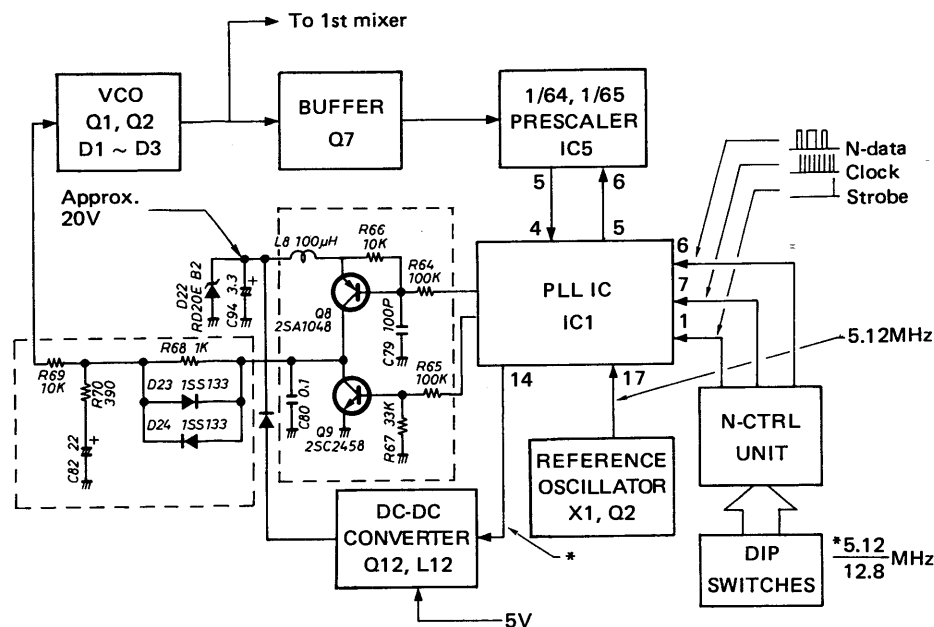

7-5 TRANSMITTER PLL CIRCUIT

(1) TRANSMITTER VCO CIRCUIT (TX-VCO UNIT)

See SECTION 7-4 (1) RECEIVER VCO CIRCUIT for detailed circuit description.

(2) PLL CIRCUIT (TX UNIT)

The VCO output signal is buffer-amplified by Q1 and is divided by 1/64 and 1/65 at a dual modulus prescaler, IC2. In addition, divided signals are applied to IC1 and divided by N-data from the N-CTRL UNIT.

IC1 includes a phase detector circuit. The divided signal is compared with the reference oscillator frequency. Detector signals are output from pins 12 and 13 of IC1.

These output signals are received at a charge pump circuit of Q6 and Q7, and are supplied with high DC voltage (+20V). Using this method, the swing of the PD (Phase Detector) voltage expands and the VCO covers a very wide frequency range. R22, R23, R24 and C22 compose a LPF for the loop filter of this PLL circuit. D2 and D3 reduce lockup time.

N-data, as previously stated, is the value obtained by dividing the object frequency by channel spacing as shown in the formula below.

$$N\text{-data} = \frac{\text{Transmit frequency}}{\text{Channel spacing}}$$

(3) REFERENCE FREQUENCY OSCILLATOR CIRCUIT (TX UNIT)

The oscillator circuit consists of crystal unit X1, transistor Q2, thermistors R13 and R16, varicap D1 and other parts. The oscillation circuit consists of a reference oscillation circuit which is highly stable in a wide temperature range. The reference oscillation is divided inside IC1 to obtain 5kHz.

A part of the frequency from pin 14 of IC1 enters a booster circuit consisting of Q8, D5, L4 and the other parts. The output voltage of Q8 is a high voltage (+20V) and is used in the charge pump circuit.

(4) UNLOCK DETECTOR CIRCUIT (TX UNIT)

When the PLL circuit is unlocked, pin 10 of IC1 is at a LOW level and the unlock detector circuit composed by Q3 outputs a HIGH level of the unlock (MUTE) signal to Q4. Q4 turns ON and Q5 turns OFF. The base bias voltages of Q10, Q11 and Q12 are removed, and thus transmit output signals are muted.

7-6 CONTROL CIRCUIT (LOGIC UNIT)

This circuit consists mainly of COR circuitry (Carrier Operated Relay) for start control. An AF oscillator circuit and a remote control signal decoder are also included for ID sendout. This control circuit can be divided into the following control categories:

1. **AF line control:**
Transmitting an AF signal.
2. **Transmission control:**
Start of transmitter circuit.
3. **Timer control:**
Hang-up timer, time-out timer, ID interval timer.

(1) AF LINE CONTROL

ID signals from pin 35 of IC1 (CPU) switch AF signals generated by IC6. To reduce tone distortion, signals are passed through a low-pass filter consisting of IC8(b) and other parts, then fed to mixer IC8(a).

AF output signals that pass through pin 4 of J4 in the RX UNIT and ID signals from IC8(b) are mixed and amplified at approximately 10dB at IC8(a). They are then mixed and signals are sent out to the TX UNIT through pin 4 of J2 on the LOGIC UNIT.

When the LOCAL INHIBIT FUNCTION is turned ON, IC8(a) is cut off by D8, and no signal is output from IC8(a).

(2) TRANSMISSION CONTROL

When the repeater receives a signal and the [BUSY] INDICATOR lights up, the repeater starts transmitting. Following are explanations for controlling the transmitter of the repeater.

The transmit circuit is activated while 2 signals are input: squelch signals from pin 4 of J1 and CTCSS decoder signals from pin 23 of IC14.

Both signals are fed to pins 8 and 9 of IC6 through a Schmitt trigger circuit consisting of two inverters in each circuit as BUSY signals.

When the [BUSY] INDICATOR lights up, IC1 sends out a signal for transmit through the PTT line on pin 5 of J2.

(3) TIMER CONTROL

Three timers are used in this unit: (1) Time-out timer, (2) ID interval timer, and (3) Hang-up timer.

The time-out timer and ID interval timer are programmed in the EPROM IC3. The hang-up timer can be selected for 0, 1, 3 and 5 seconds by combinations of switches S1-1 and S1-2. These are connected to the input terminals of pins 33 and 34 of IC1 (CPU).

(4) OTHERS

The ON-OFF signal of the [LOCAL INHIBIT] SWITCH is latched at IC4(a) through pin 1 of J4 and passes to IC1 (CPU) through Q2. The output signal also controls the [LOCAL INHIBIT] INDICATOR.

The ON-OFF signal of the [CTCSS] SWITCH is latched at IC4(b). When the [CTCSS] SWITCH is pushed and the [CTCSS] INDICATOR lights up, pin 12 of IC4(b) is at a LOW level and the CTCSS decoder circuit is turned ON. In addition, the output signal from IC4(b) controls the [CTCSS] INDICATOR through Q4.

The two latch circuits in IC4 receive a signal from IC11 and IC13 for setting or resetting operations.

The signal from the [COR SIMULATE] SWITCH is directly applied to pin 29 of IC1 (CPU).

■ CONTROL CIRCUIT BLOCK DIAGRAM

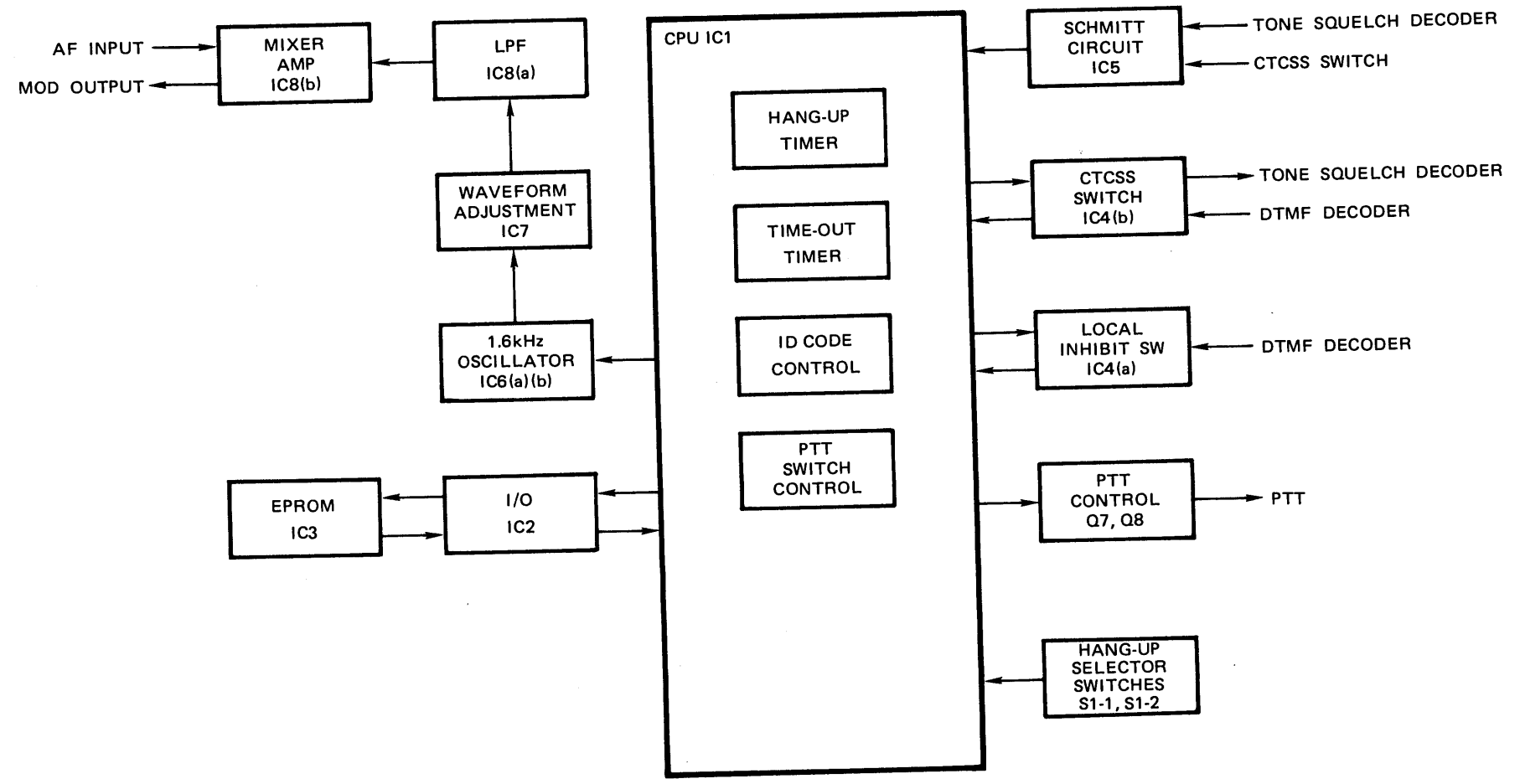

7-7 CTCSS DECODER CIRCUIT (LOGIC UNIT)

The CTCSS decoder circuit consists of IC15, IC14, IC4(b), Q11 and Q12.

Discriminated AF signals from pin 2 of J2 on the LOGIC UNIT pass through low-pass filter IC15 and are fed to pin 29 of IC14.

IC14 is a tone encoder/decoder IC chip. However, the encoder function is not used. The tone decoder frequency is determined by the S2 dip switches.

When IC14 acknowledges input signals, pin 23 of IC14 becomes "HIGH", turning Q11 and Q12 ON.

IC4 is a flip-flop IC chip that controls Q12 emitter voltage using the front panel CTCSS SWITCH or DTMF signal control.

7-8 N-CONTROL CIRCUIT (N-CTRL UNIT)

This unit has two independent generators for the receiver and transmitter PLL circuit which generate N-data, clock, and strobe signals.

Following is a description for the generator used in the RX UNIT (identical to the generator used in the PLL circuit).

IC6 functions as a clock generator.

IC7 functions as a clock counter and strobe generator. When IC7 counts 17 clocks, pin 11 of IC8 outputs a strobe signal.

IC9 and IC10 function as a parallel-serial converter and convert parallel signals for PLL N-data which is set by dip switches S3 and S4 for serial N-data.

IC10 outputs N-data signals as a binary code.

7-9 DTMF DECODER CIRCUIT (LOGIC UNIT)

AF signals from the RX UNIT are fed to Q9 on the LOGIC UNIT through J3 and signals are amplified.

IC9 is an IC chip for the DTMF detector. An applied double-tone signal is detected at IC9 and outputs signals as a 4-bit binary code.

IC10 reverses the output signals and converts the signals from 9Vp-p to 5Vp-p.

IC11 converts the input signals to signals of hexadecimals and the signals are fed to IC12 and IC13.

A group of signals is checked for its combination at IC12 or IC13, and is output from pin 9 or pin 10 via IC12, or from pin 9 or pin 10 through IC13.

These signals are then sent to CTCSS switch circuit IC4(b) or local inhibit switch circuit IC4(a) to activate their respective functions.

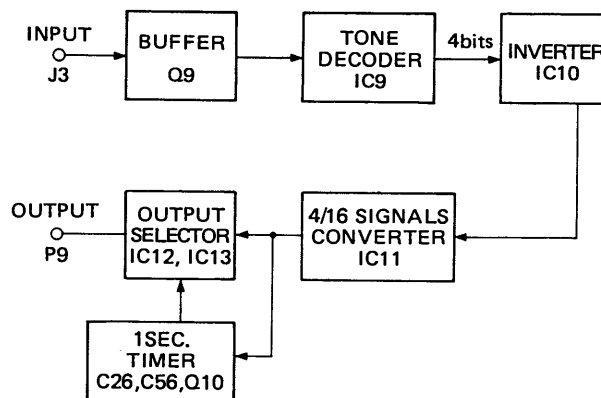

8. MAINTENANCE AND ADJUSTMENT

8-1 MAINTENANCE

DANGER: HIGH VOLTAGE

The regulator circuit in the IC-RP2210 contains high voltages that are potentially **LETHAL** when operating the repeater with an AC power source. A DC power source (13.8V) should be used if the repeater case is removed for servicing.

(1) FUSE REPLACEMENT

If the fuse blows or the transceiver stops functioning, track down the source of the problem, and replace the damaged fuse with a new, rated fuse.

WARNING: Disconnect the AC cord from the AC outlet to prevent electric shocks when changing the fuse.

- AC line fuse : 5A
- DC line fuse : 10A

(2) CHECKING

Since the IC-RP2210 contains high voltages and is a powerful full duplex repeater, the unit is liable to become hot while operating.

The following items should be checked periodically to ensure steady repeater operations:

- ① AC cord connection
- ② DC power cable connection
- ③ Antenna connectors connection
- ④ Antenna system
- ⑤ Backup battery life
- ⑥ Burning smell from the repeater
- ⑦ Heat from the repeater

8-2 PREPARATION BEFORE SERVICING

- 1) Detach the power cord and turn OFF the [POWER] SWITCH before performing any work on the repeater.
- 2) **DO NOT** short circuit components while making adjustments.
- 3) Use an insulated tuning tool for all adjustments.
- 4) **DO NOT** force any of the variable components. Turn them slowly and smoothly.
- 5) Follow the instructions exactly. If an indicated result is not obtained, repeat the instruction until the correct result is obtained.

6) Check the condition of connectors, solder joints and screws when adjustments are complete. Make sure components do not touch each other.

7) Confirm defective operation of the repeater first when checking an out-of-service unit. Verify that external sources do not cause the problem.

8) Use the correct tools and test equipment.

9) For transmission problems, connect a dummy load to the transmitter antenna connector.

For reception problems, connect an antenna or signal generator to the receiver antenna connector.

10) Recheck for the suspected malfunction with the POWER SWITCH ON.

11) Check the defective circuit. Measure the DC voltages of the collector, base and emitter of each transistor.

The voltage between the base and emitter should be 0.6V when the transistor is activated.

8-3 INSIDE VIEWS

•TOP VIEW

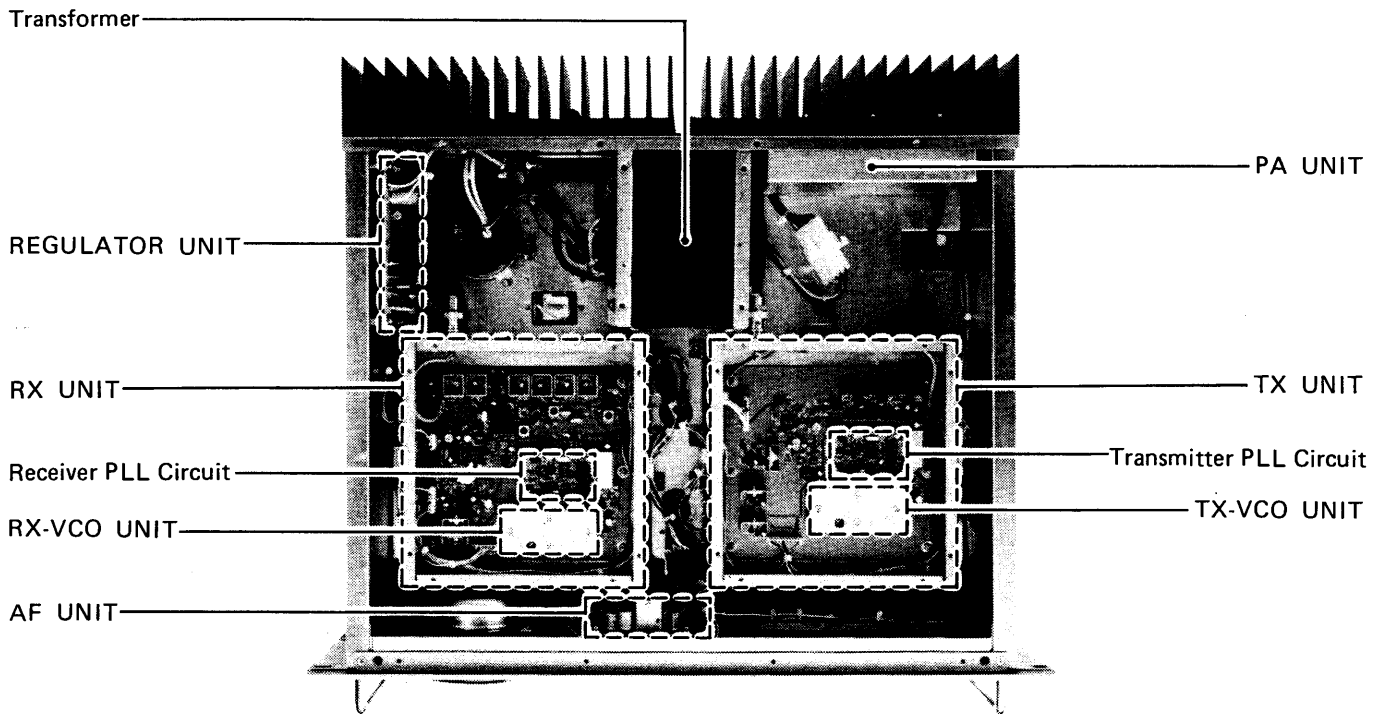

•BOTTOM VIEW

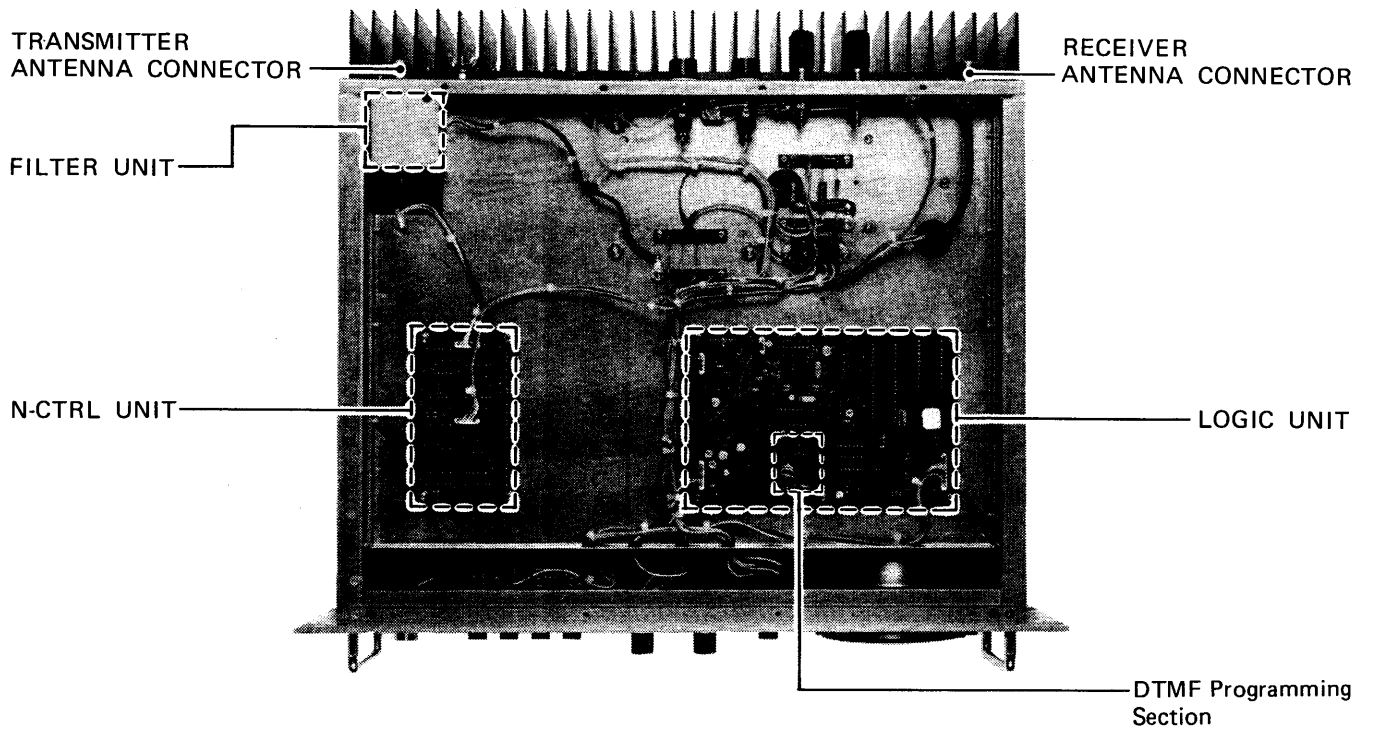

8-4 RECEIVER PLL ADJUSTMENT

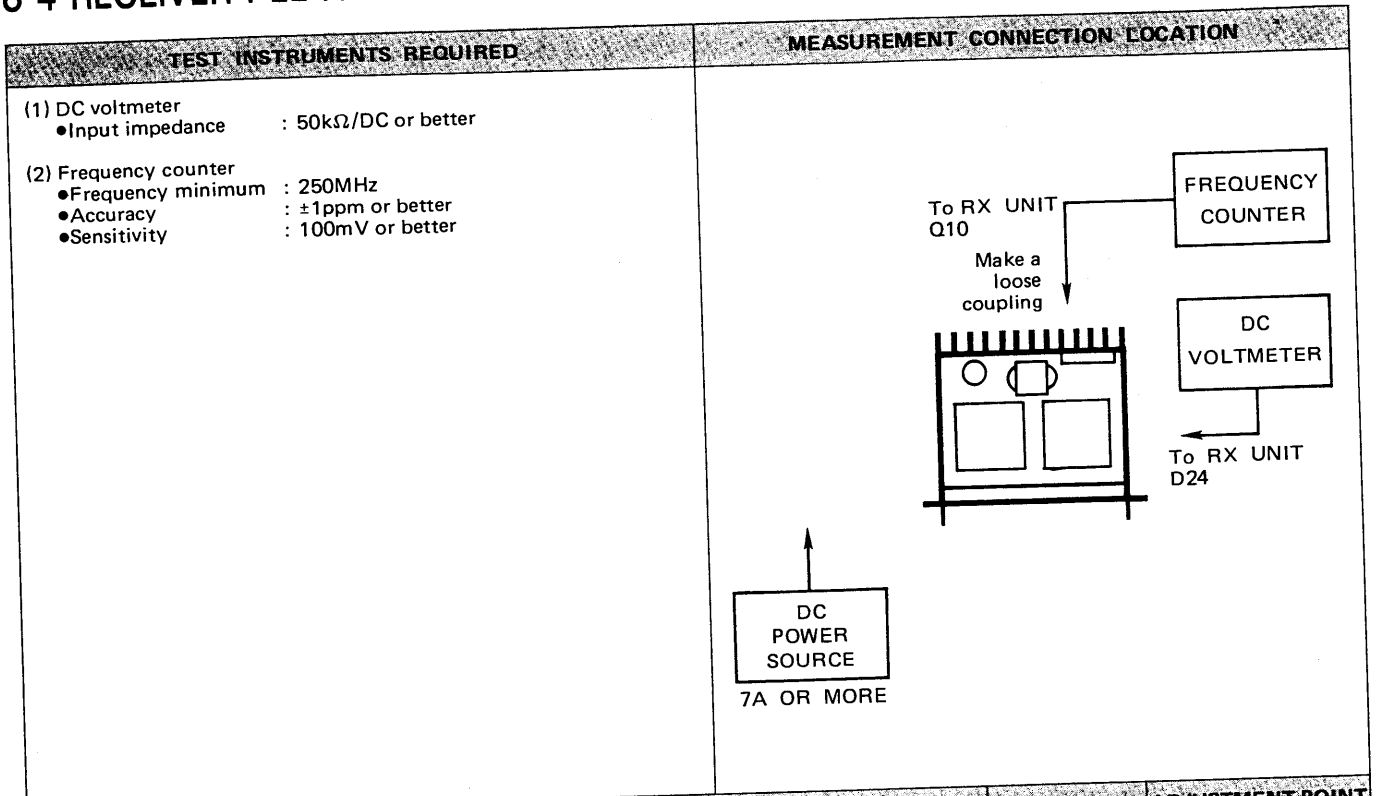

ADJUSTMENT	ADJUSTMENT CONDITIONS	MEASUREMENT		VALUE	ADJUSTMENT POINT	
		UNIT	LOCATION		UNIT	ADJUST
LOCK VOLTAGE	1 <ul style="list-style-type: none"> • Set the receive frequency: 220.00MHz. See p. 5 - 2 for the N-data calculation formula. • Set dip switches S1 and S2. See the diagram at right. 	N-CTRL	N-CTRL UNIT Receive frequency setting	(N-data = 39640) S1 S2		
	2 <ul style="list-style-type: none"> • Receive mode 	RX	Connect a voltmeter to the cathode of D24.	2.5V	RX-VCO	C1
REFERENCE FREQUENCY	1 <ul style="list-style-type: none"> • Receive mode • Set the receive frequency: 220.00MHz. See the LOCK VOLTAGE adjustment for setting the N-data. 	RX	Make a loose coupling between a frequency counter and Q10.	198.20MHz	RX	C67

•RX UNIT

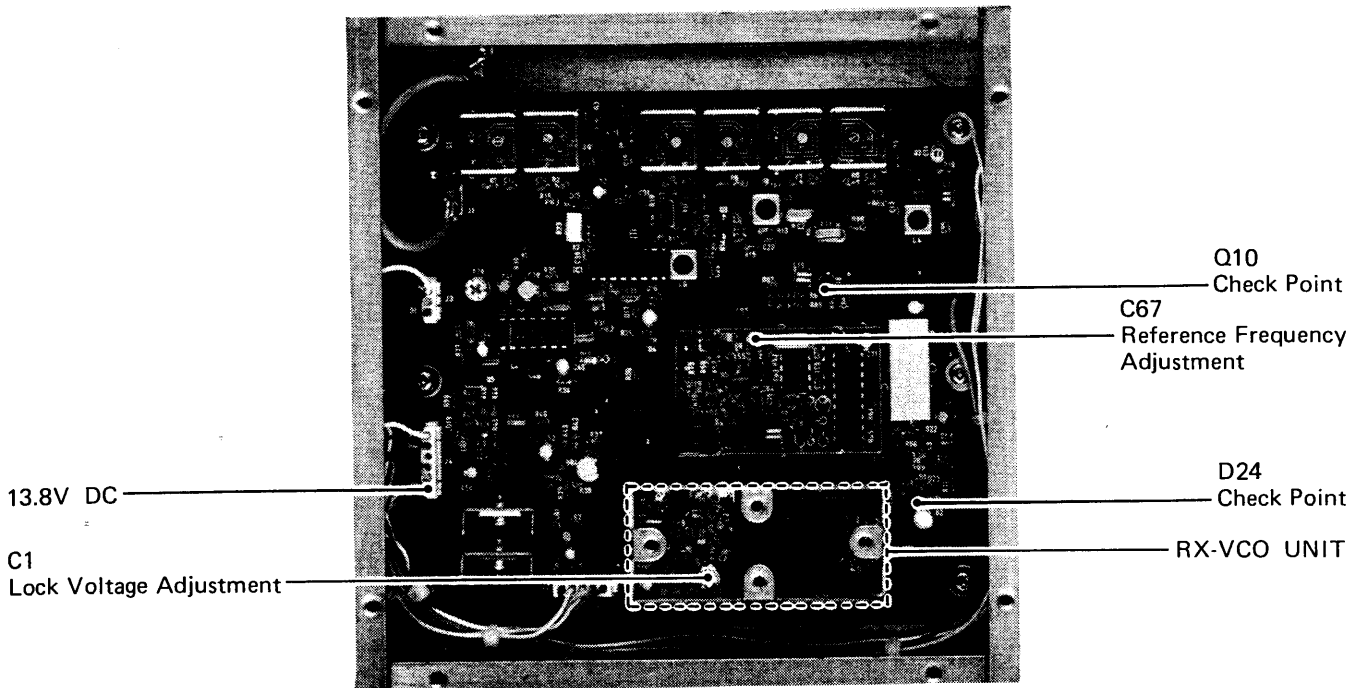

8-5 TRANSMITTER PLL ADJUSTMENT

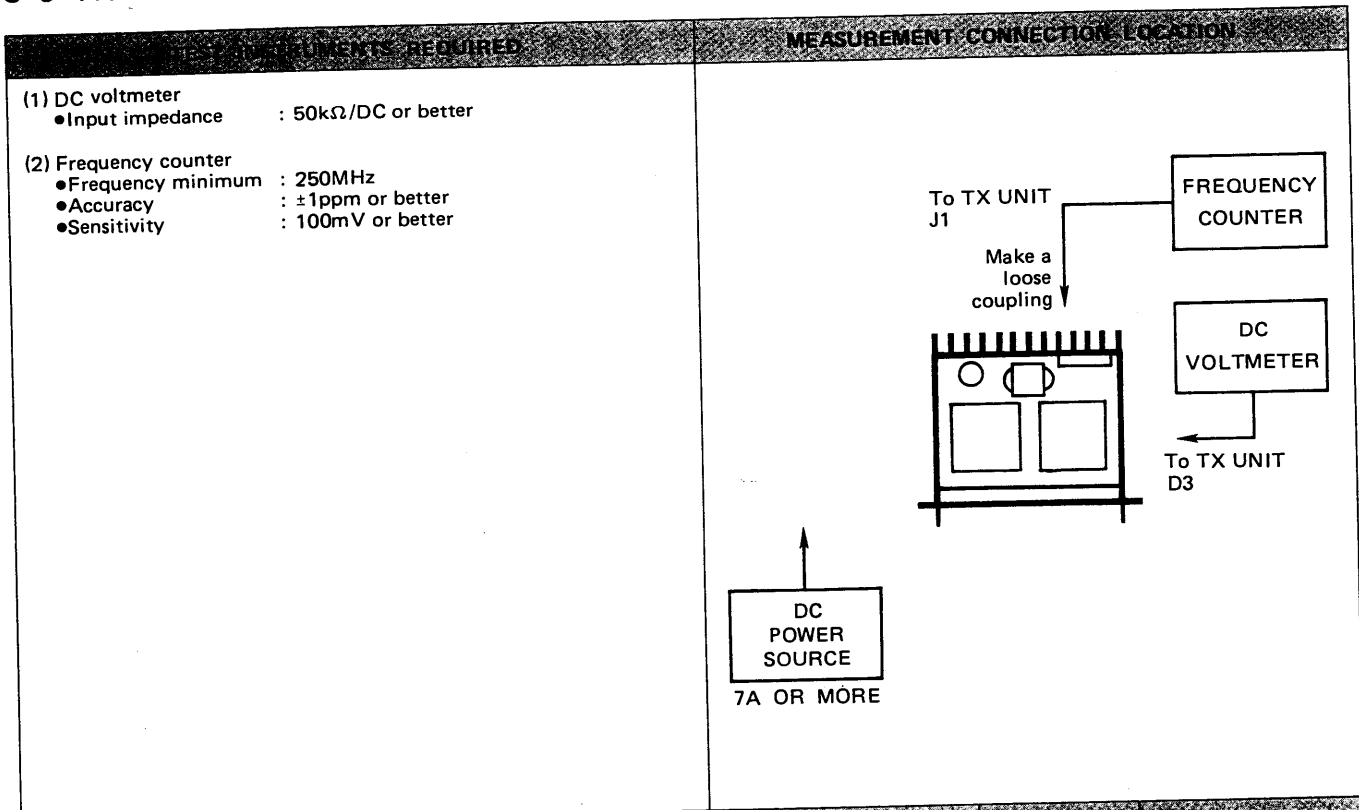

TEST POINT	TEST POINT NO.	TEST POINT CONDITIONS	MEASUREMENT		VOLUME	ADJUSTMENT POINT	
			UNIT	LOCATION		UNIT	ADJUST
LOCK VOLTAGE	1	<ul style="list-style-type: none"> Set the transmit frequency: 225.00MHz. See p. 5-3 for the N-data calculation formula. Set dip switches S3 and S4 as shown in the diagrams at right. 	N-CTRL	<p>Transmit frequency setting</p>	<p>(N-data = 45000)</p> <p>S3 S4</p>		
	2	<ul style="list-style-type: none"> Transmit mode 	TX	Connect a voltmeter to the cathode of D3.	6.0V	TX-VCO	C1
REFERENCE FREQUENCY	1	<ul style="list-style-type: none"> Transmit mode Frequency : 225.00MHz Remove P1 from J1 	TX	Make a loose coupling between a frequency counter and J1.	225.00MHz	TX	C12
	NOTE: Re-plug P1 to J1 after the adjustment is finished.						

•TX UNIT

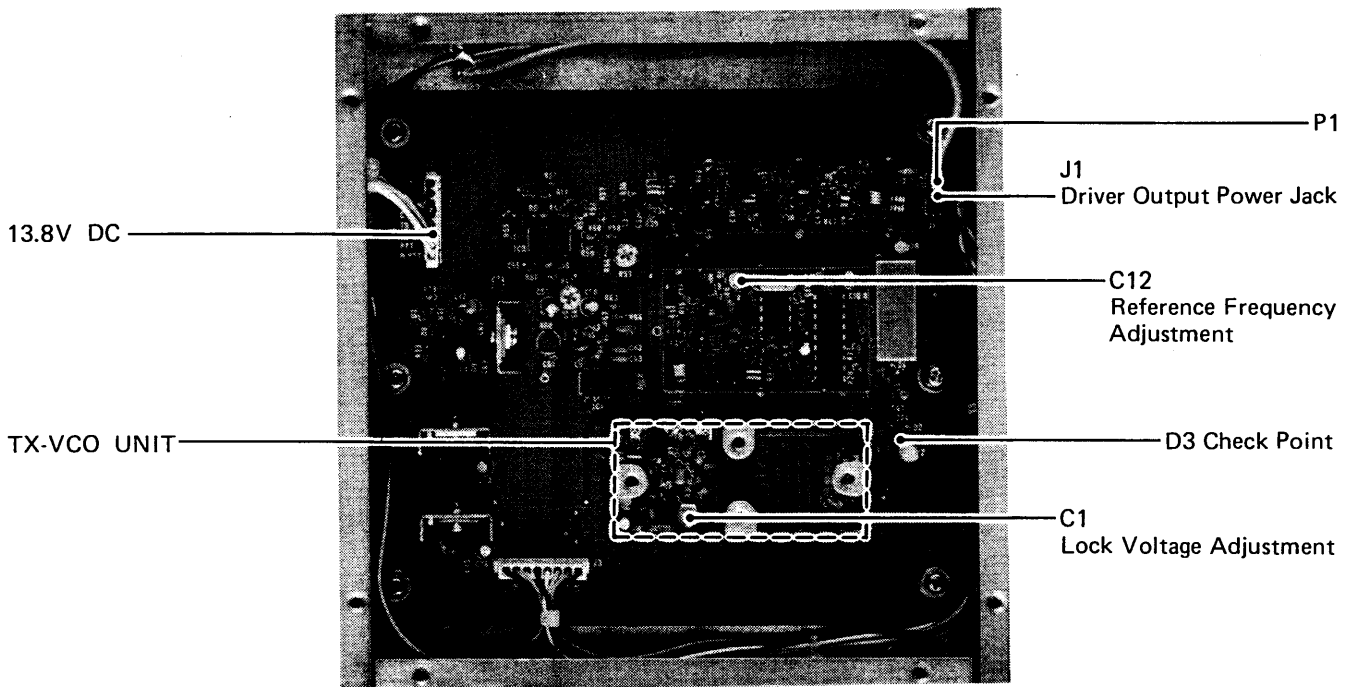

8-6 RECEIVER ADJUSTMENT

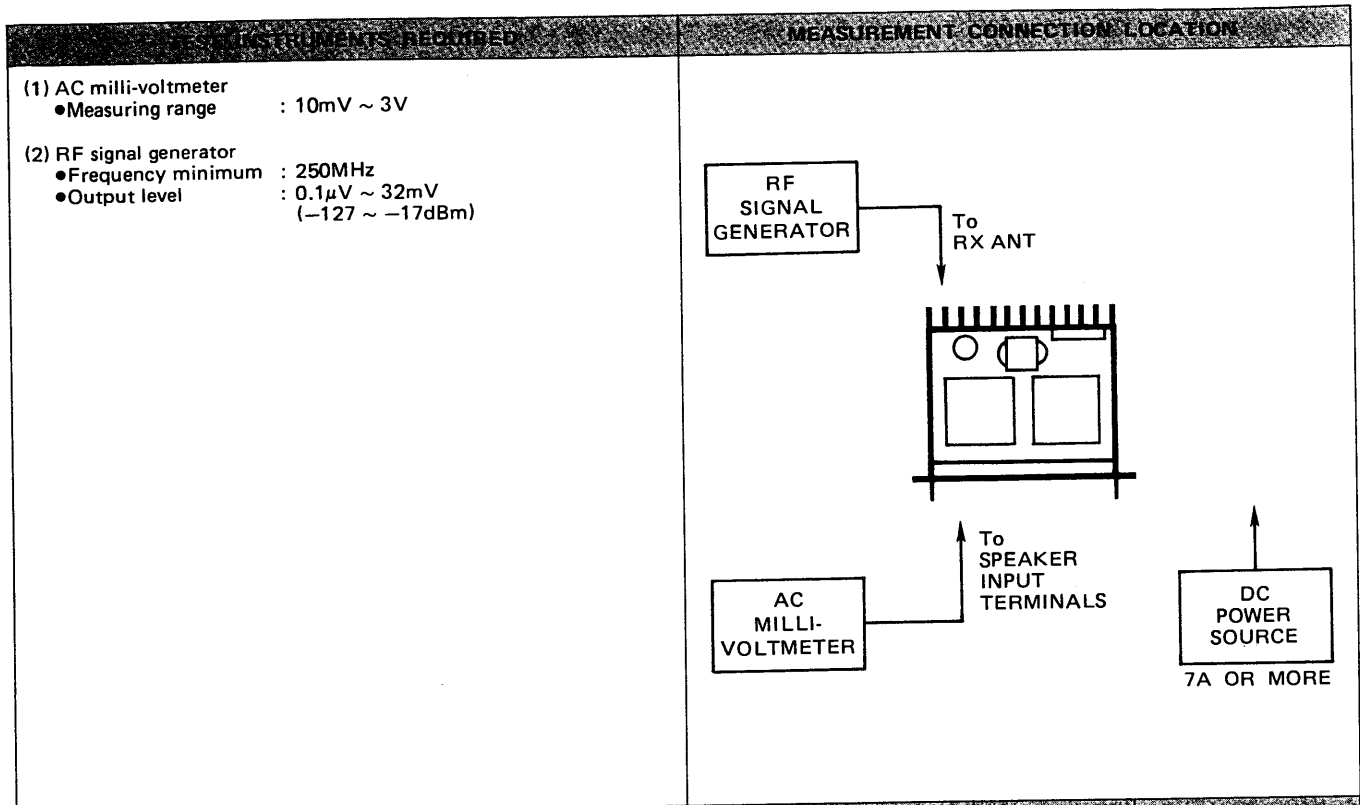

ADJUSTMENT	ADJUSTMENT CONDITIONS	UNIT	MEASUREMENT LOCATION	VALUE	ADJUSTMENT POINT		
					UNIT	ADJUST	
SENSITIVITY	1	<ul style="list-style-type: none"> ●Receive mode ●Apply an RF signal to the RECEIVER ANTENNA CONNECTOR. Level : 10μV (-87dBm) Dev : ±3.5kHz Mod : 1kHz Frequency : 220.00MHz 	FRONT PANEL	Connect an AC milli-voltmeter to the input terminals of the INTERNAL SPEAKER.	Maximum level More than -117dBm for 12dB SINAD.	RX	C2, C3, C7, C8, C9, C10, C11, L4, L5, L6
	NOTE: Repeat this adjustment several times to obtain maximum receiver sensitivity.						
SQUELCH THRESHOLD POINT	1	●Set the SQUELCH CONTROL to the 10 o'clock position.	FRONT PANEL		10 o'clock	FRONT PANEL	
	2	<ul style="list-style-type: none"> ●Apply an RF signal to the RECEIVER ANTENNA CONNECTOR. Level : 0.18μV (-122dBm) Frequency : 220.00MHz 			At the point where the squelch just opens.	RX	R28

•RX UNIT

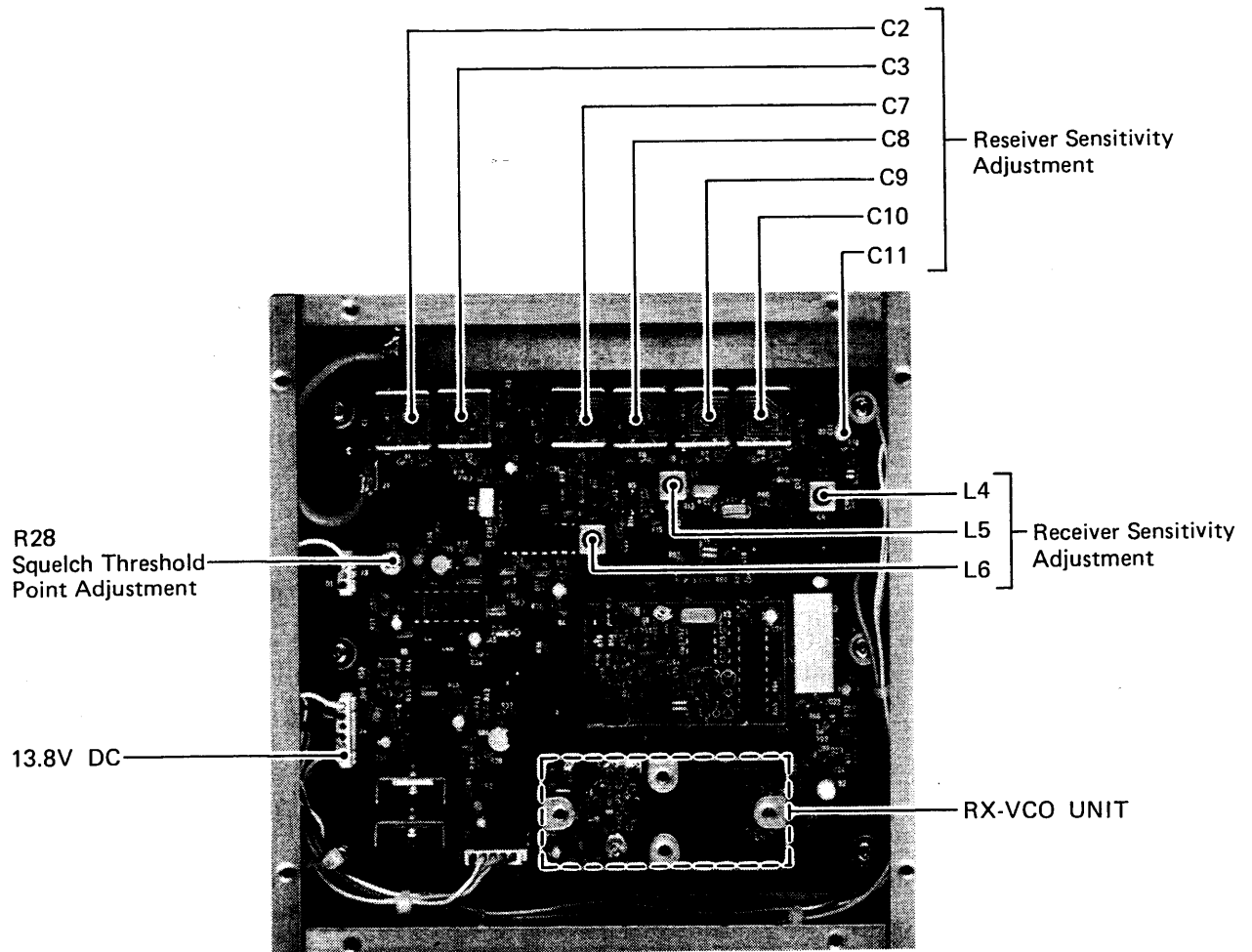

8-7 TRANSMITTER ADJUSTMENT

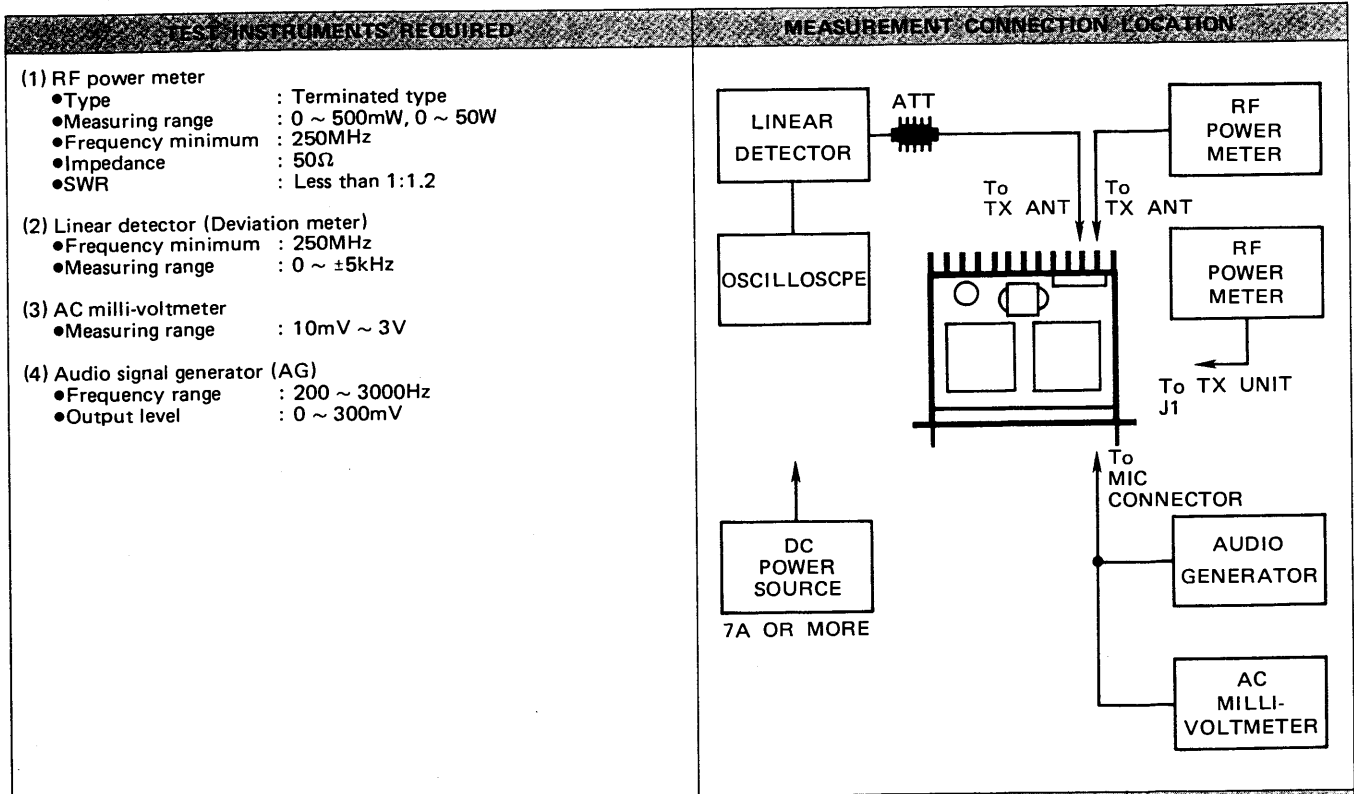

ADJUSTMENT	ADJUSTMENT CONDITIONS	MEASUREMENT			ADJUSTMENT POINT	
		UNIT	LOCATION	VOLUME	UNIT	ADJUST
DRIVER OUTPUT	<ul style="list-style-type: none"> •Remove P1 from J1 •Transmit mode <p>NOTE: Re-plug P1 to J1 after the adjustment is finished.</p>	TX	Connect a power meter to J1.	More than 300mW	TX	Verify
DEVIATION	<ul style="list-style-type: none"> •Transmit frequency: 225.00MHz •Apply an AF signal to the MIC CONNECTOR. Level : 40mV Frequency : 1000Hz 	REAR PANEL	Connect a linear detector to the TRANSMIT ANTENNA CONNECTOR through an attenuator. LPF : 20kHz HPF : OFF De-emphasis : OFF Detector : $\frac{P-P}{2}$	±4.5kHz	TX	R62
		FRONT PANEL	Connect an AC milli-voltmeter to the audio generator in parallel.			
MODULATION	<ul style="list-style-type: none"> •Transmit frequency: 225.00MHz •Apply an AF signal to the MIC CONNECTOR. Level : 4mV Frequency : 1000Hz 		Connect an oscilloscope to the output terminals on the linear detector.	<p>Same waveforms.</p>	TX	R57
OUTPUT POWER	<ul style="list-style-type: none"> •Transmit mode 	REAR PANEL	Connect a power meter.		25W	FILTER

•TX UNIT

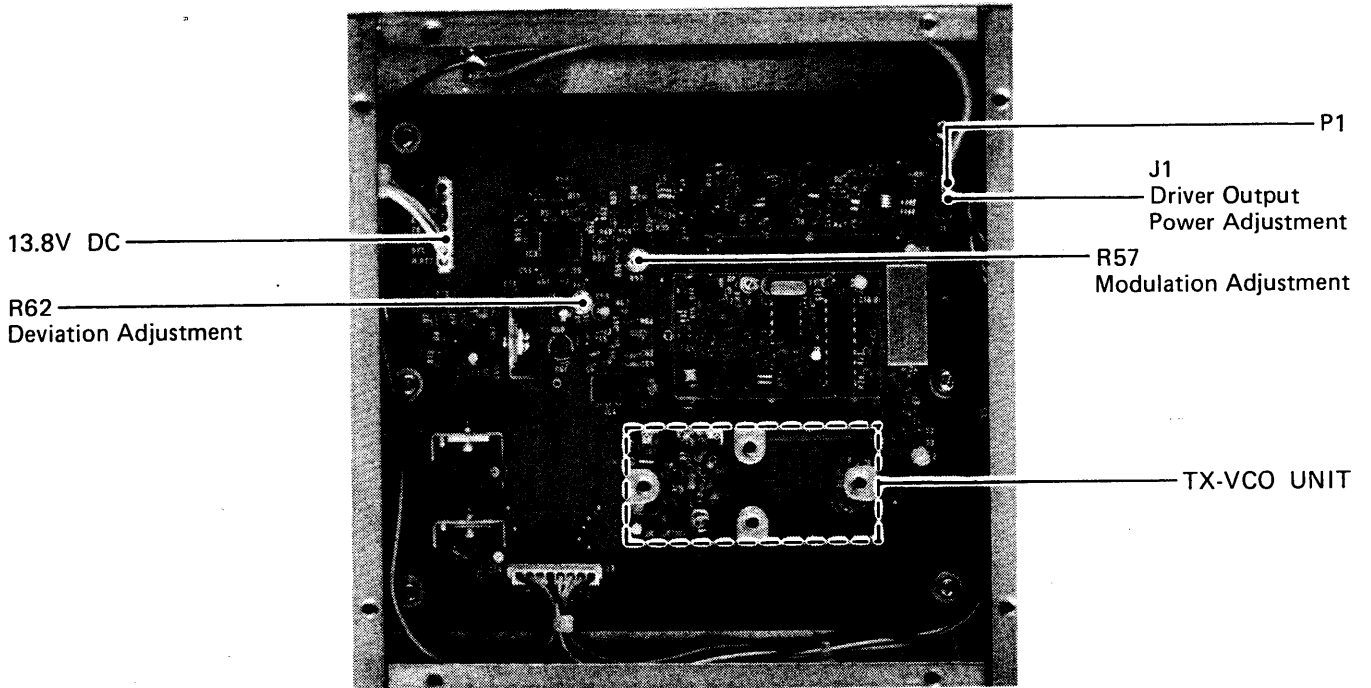

•BOTTOM VIEW

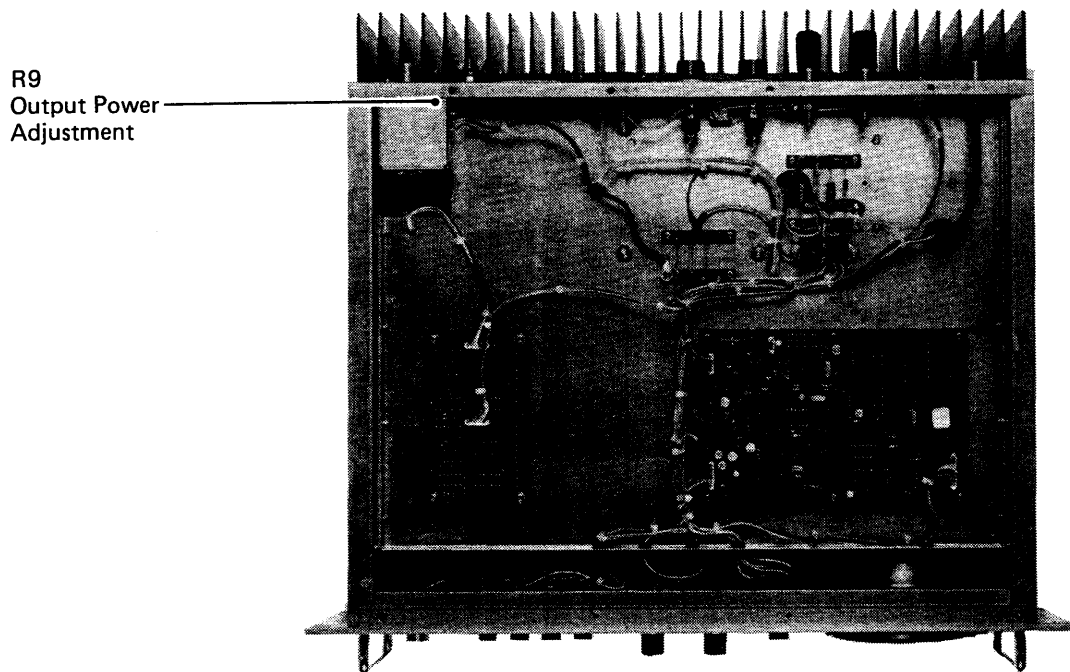

8-8 LOGIC AND REGULATOR ADJUSTMENT

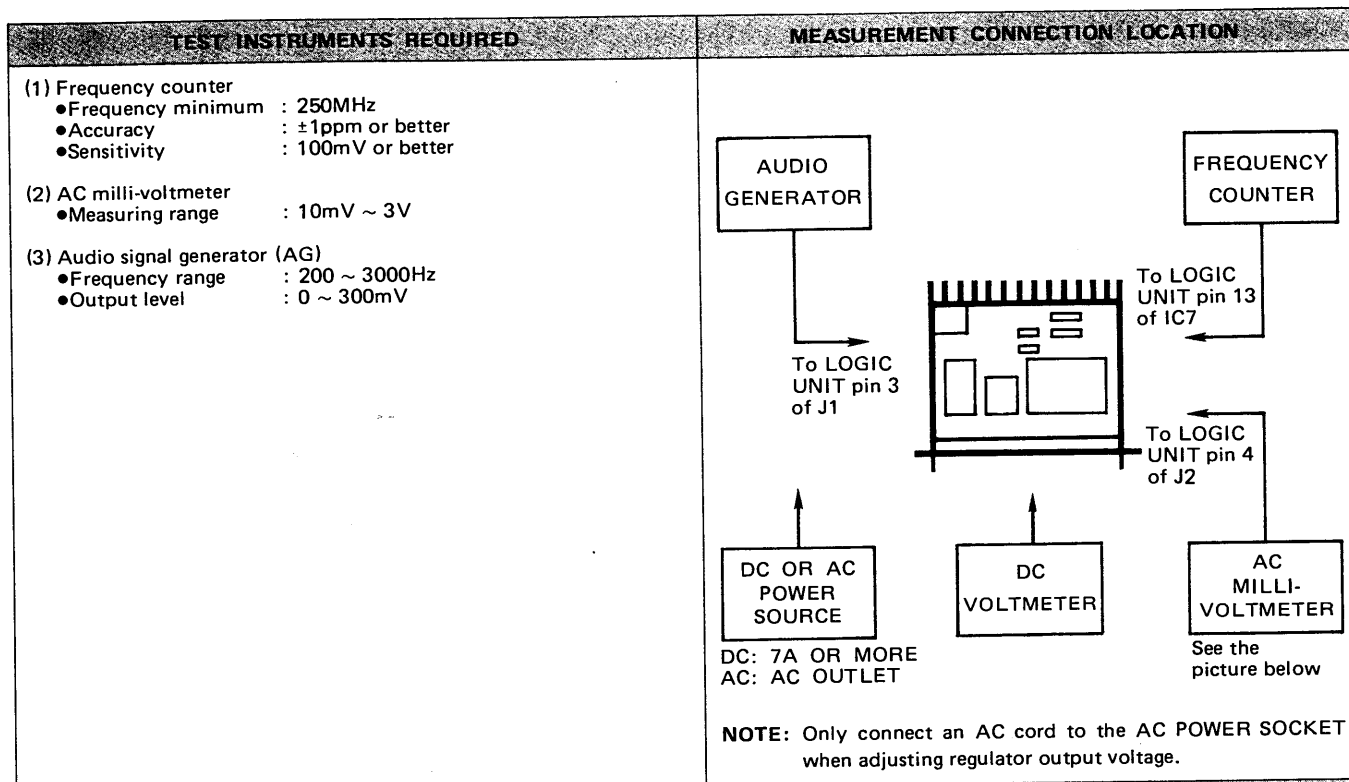

ADJUSTMENT	ADJUSTMENT CONDITIONS	MEASUREMENT		VALUE	ADJUSTMENT POINT	
		UNIT	LOCATION		UNIT	ADJUST
ID TONE FREQUENCY	1 ●Re-connect W10 before adjusting if the wire is cut. NOTE: Disconnect W10 after the adjustment is finished.	LOGIC	Connect a frequency counter to pin 13 of IC7.	800Hz	LOGIC	R38
TONE MIXER GAIN	1 ●Connect W10 before adjusting if the wire is cut. ●Apply an AF signal to pin 3 of J1 on the LOGIC UNIT. Level : 250mV Frequency : 1000Hz	LOGIC	Connect an AC milli-voltmeter to pin 4 of J2.	750mV	LOGIC	R48
	2 ●Re-connect W10 before adjusting if the wire is cut. ●Apply no signal. NOTE: Disconnect W10 after the adjustment is finished.			200mV		R40
REGULATOR OUTPUT VOLTAGE	1 DANGER: Be careful of HIGH VOLTAGE when adjusting regulator output voltage. ●Rotate R6 max. CCW.		Connect a voltmeter at the point shown in the picture below.	14.0V	REGULATOR	R4

CCW: Counterclockwise

Point where thick red wire is connected

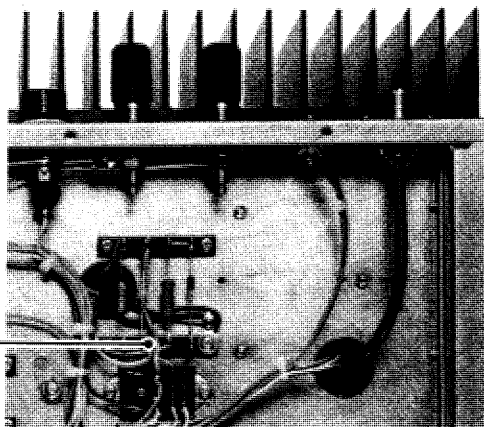

•LOGIC UNIT

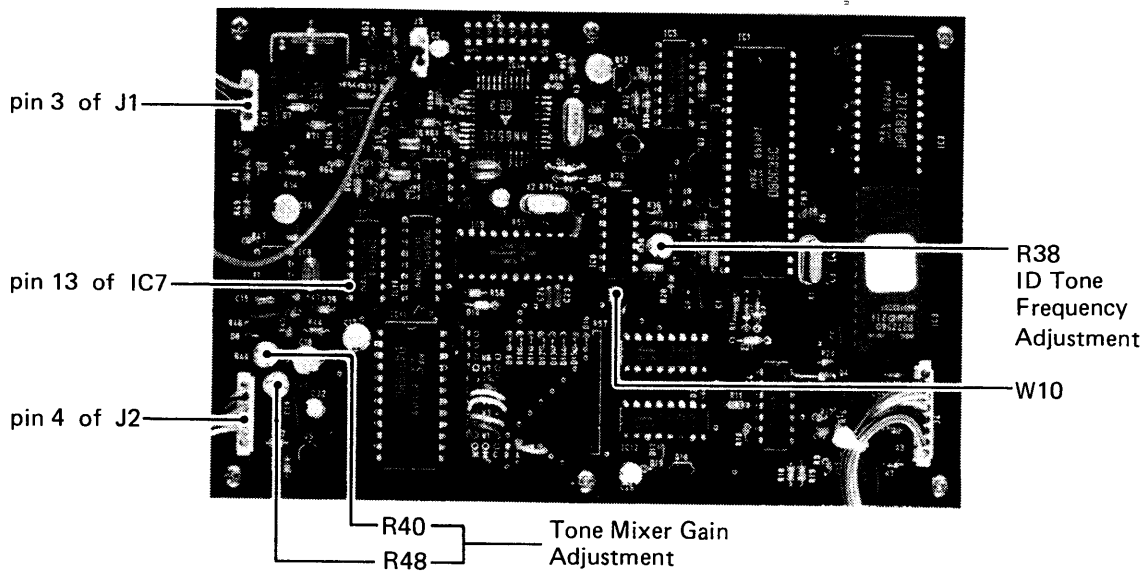

•REGULATOR UNIT

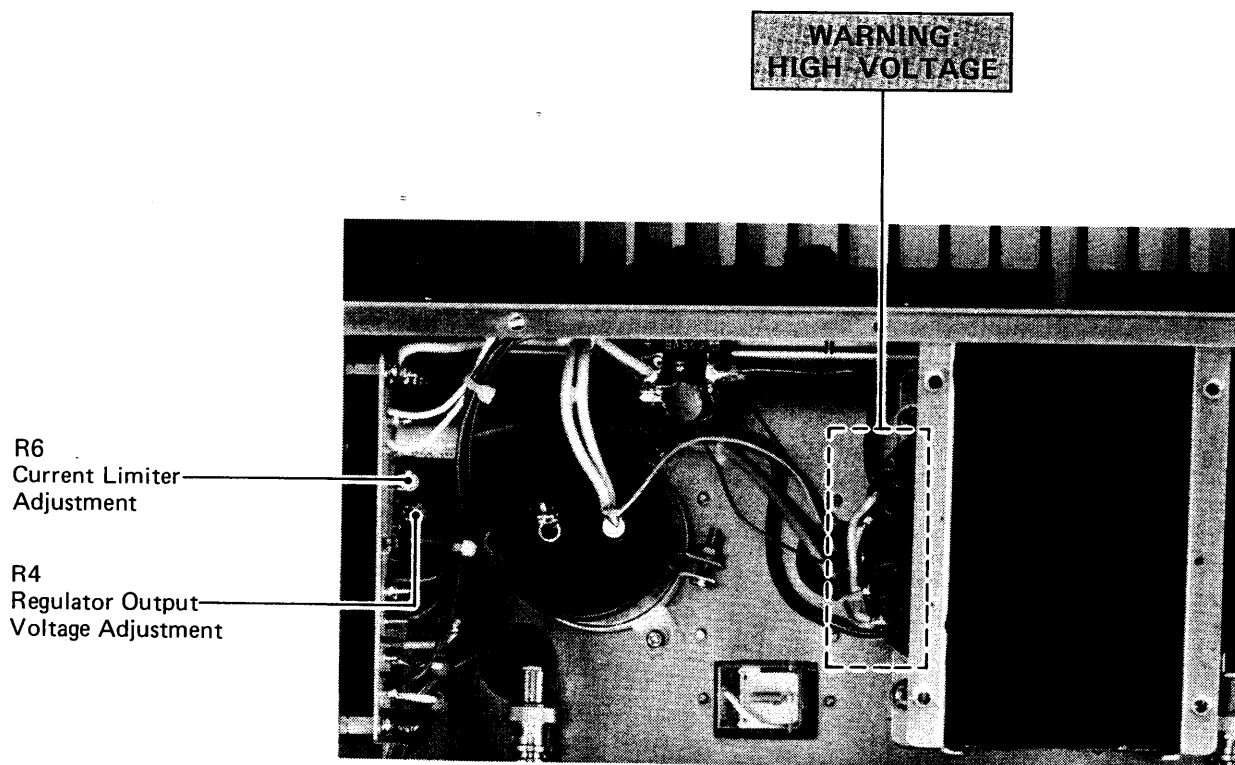

9. BOARD LAYOUTS

9-1 RX UNIT

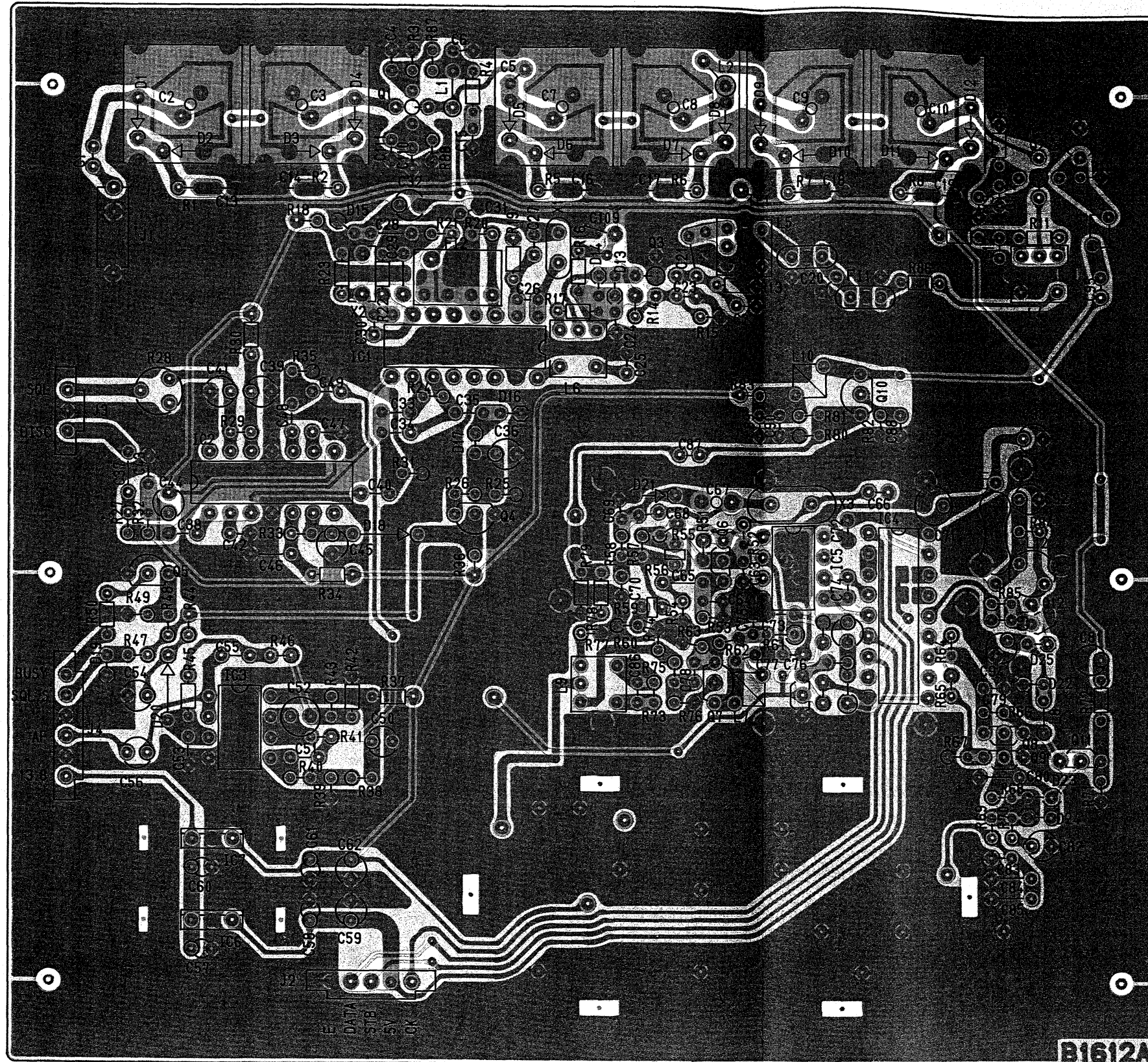

2SA1048
Q8

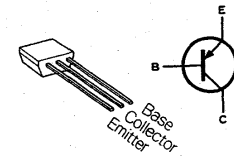

2SC945
Q4

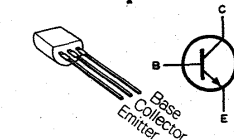

2SC1645
Q5

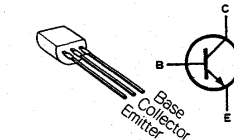

2SC2026
Q7, Q10

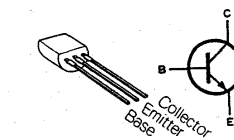

2SC2458
Q6, Q9

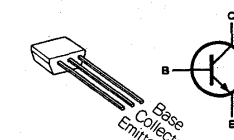

2SC3327
Q12

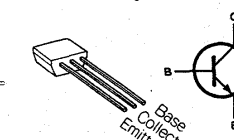

2SK184
Q11

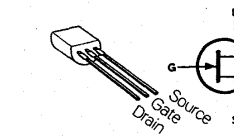

3SK121
Q1, Q2

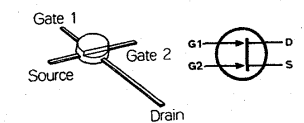

3SK122
Q3

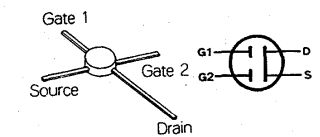

9-2 TX UNIT

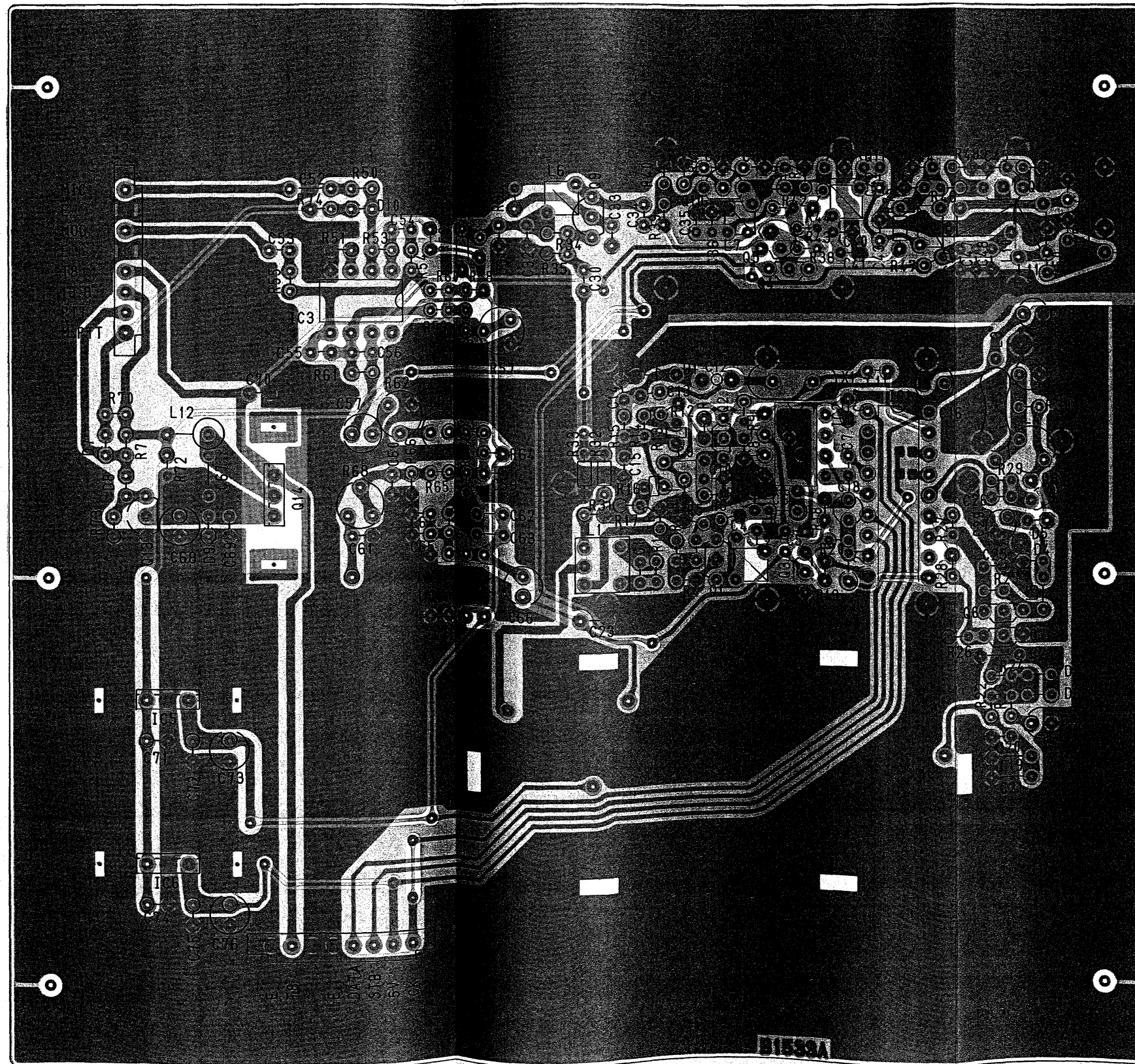

2SA1048
Q6

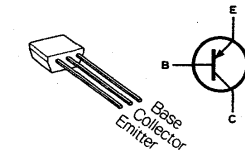

2SC945
Q13

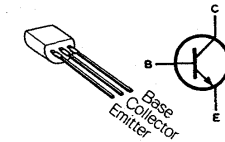

2SC1815
Q5

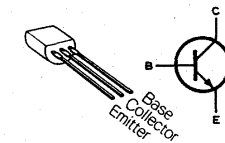

2SC2026
Q1, Q9, Q10

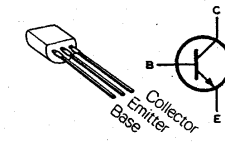

2SC2053
Q12

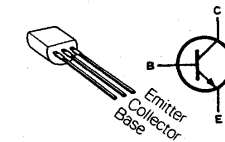

2SC2407
Q11

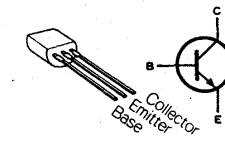

2SC2458
Q2, Q3, Q4, Q7

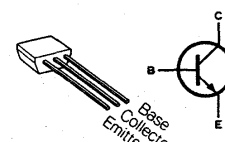

2SC3327
Q8

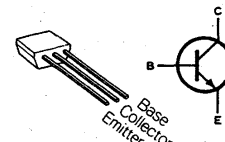

2SD880
Q14

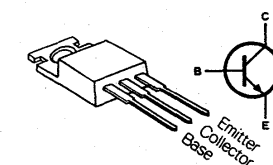

9-3 RX-VCO AND TX-VCO UNITS

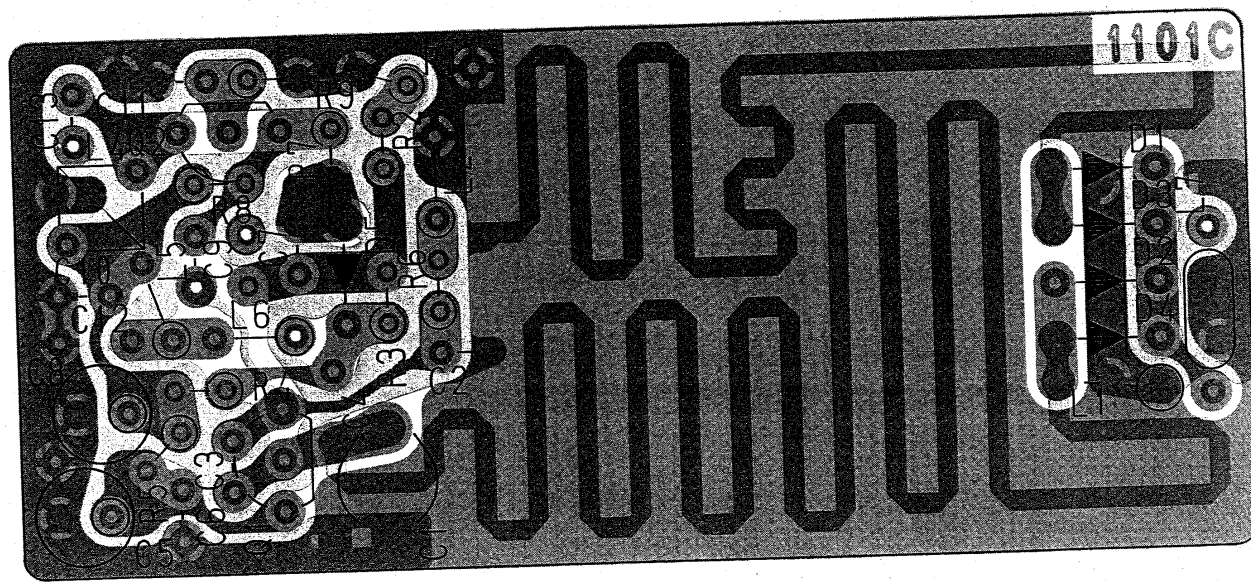

2SK125
Q1

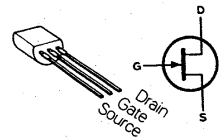

2SC2026
Q2

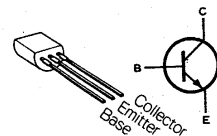

9-4 N-CTRL UNIT

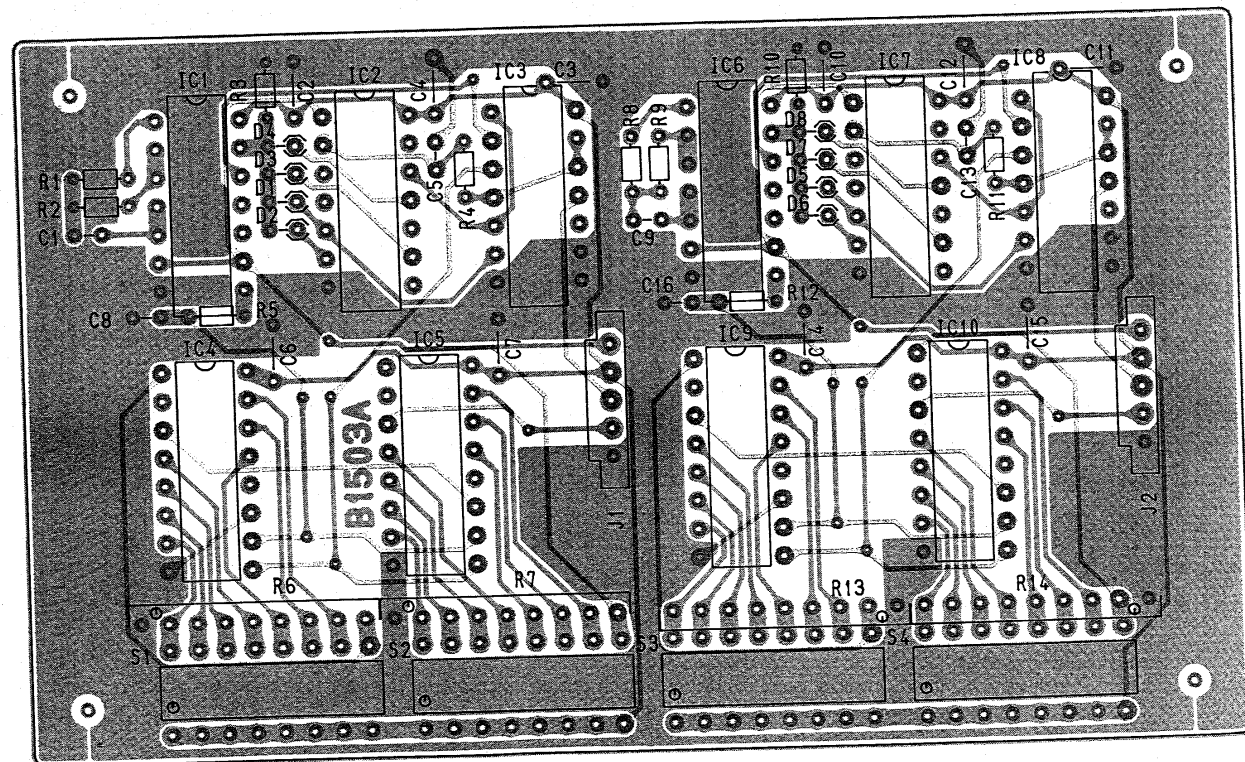

9-5 REGULATOR UNIT

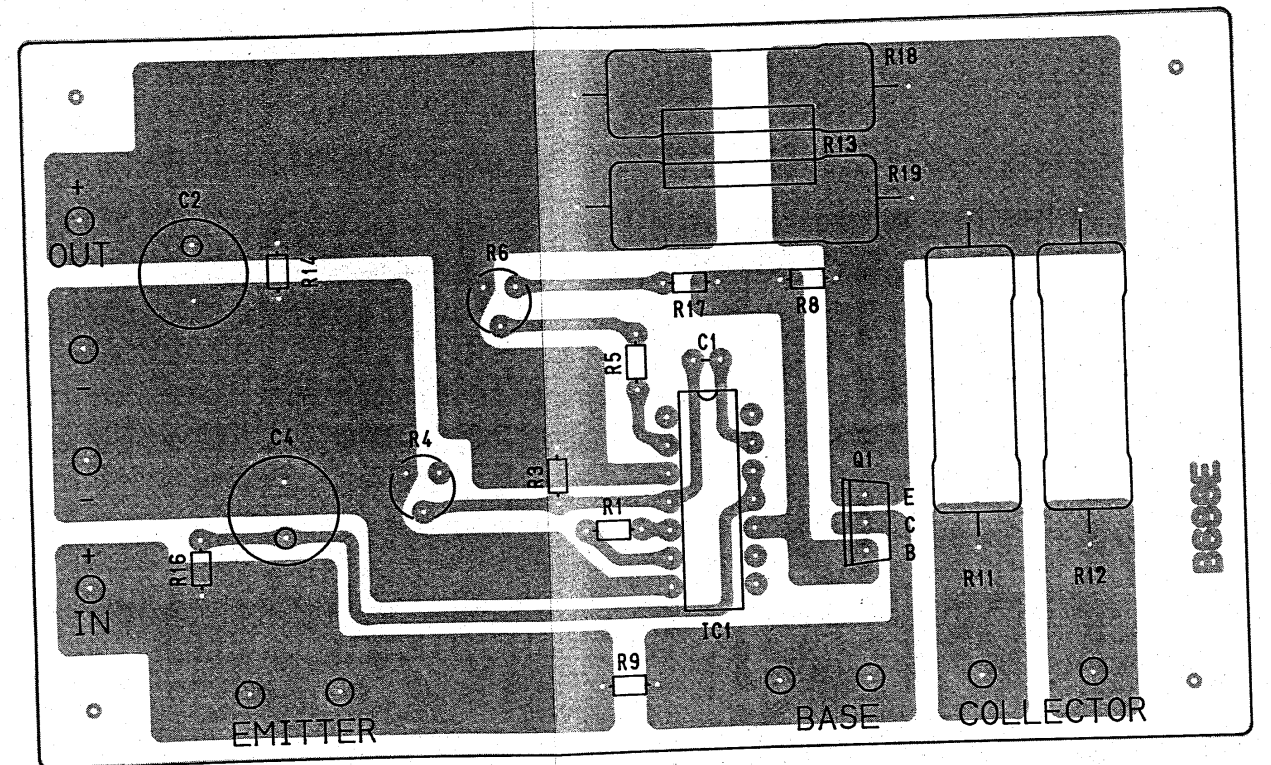

2SD880
Q1

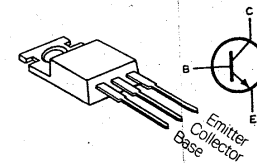

9-6 AF UNIT

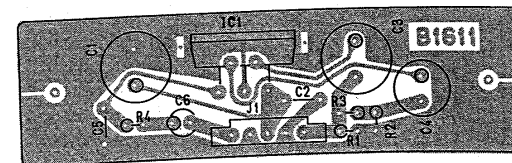

9-7 PA UNIT

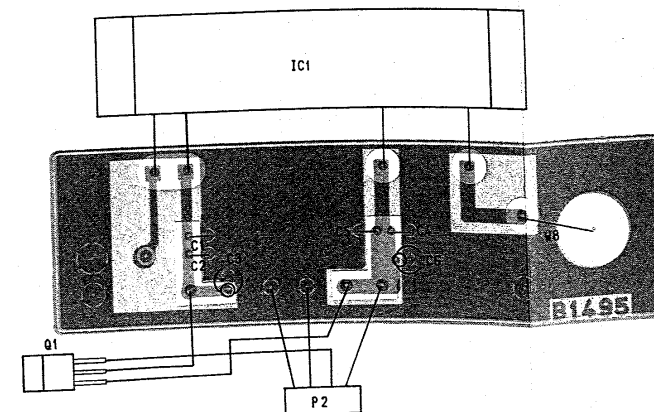

2SA1359
Q1

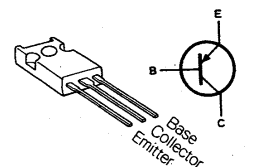

9-8 LOGIC UNIT

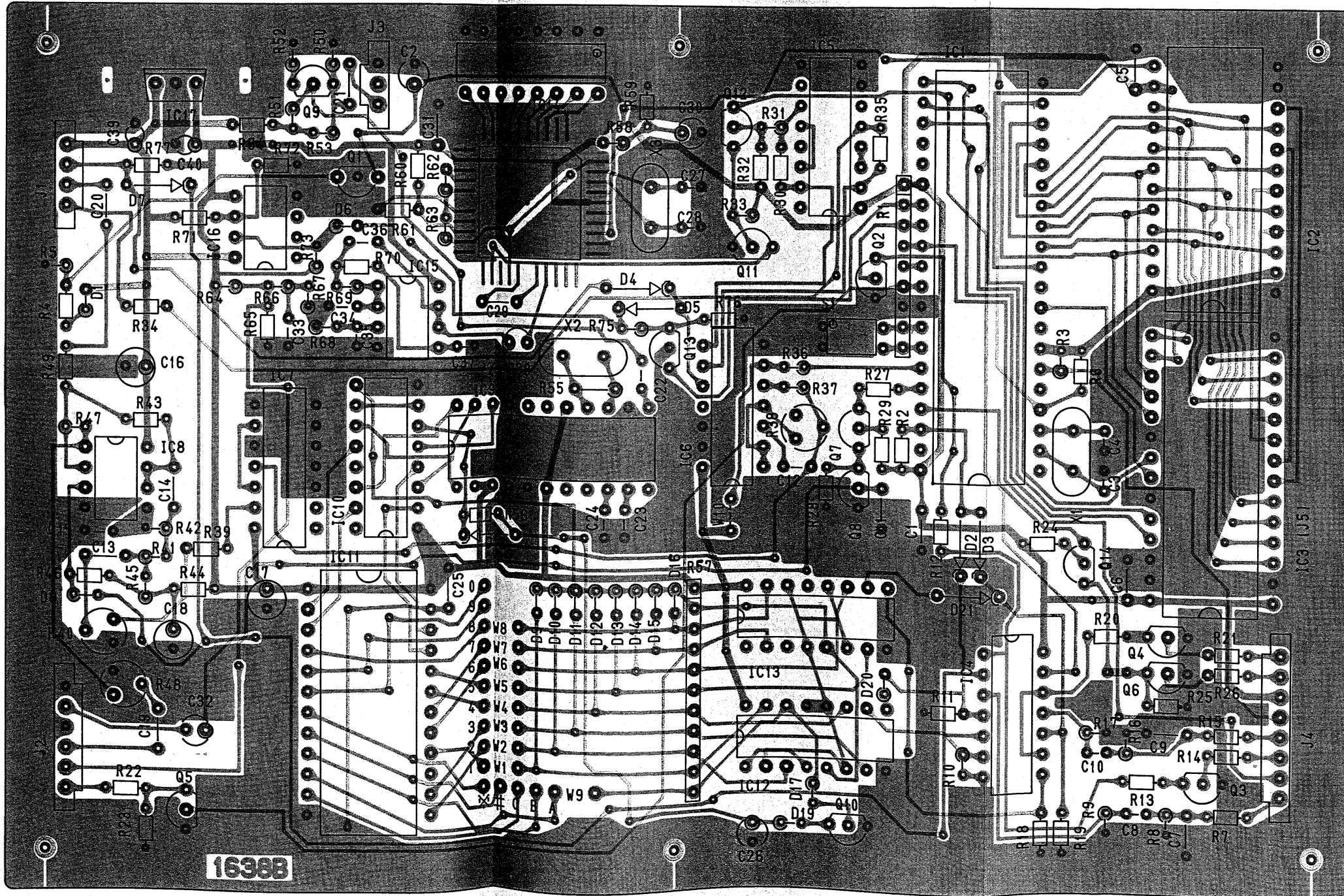

2SA1015
Q1, Q13

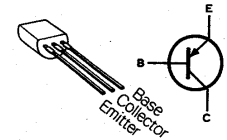

2SC945
Q2, Q3, Q4,
Q5, Q6, Q7

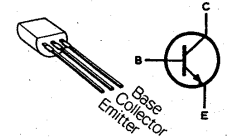

2SD468
Q8

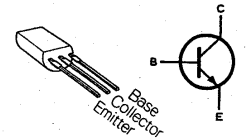

2SC1815
Q9

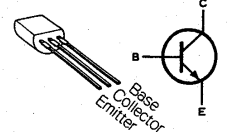

2SC1645
Q10

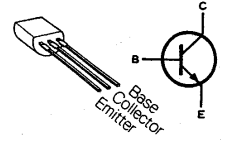

2SC3399
Q11, Q12, Q14

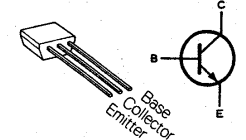

10. UNIT INTERCONNECTIONS DIAGRAM

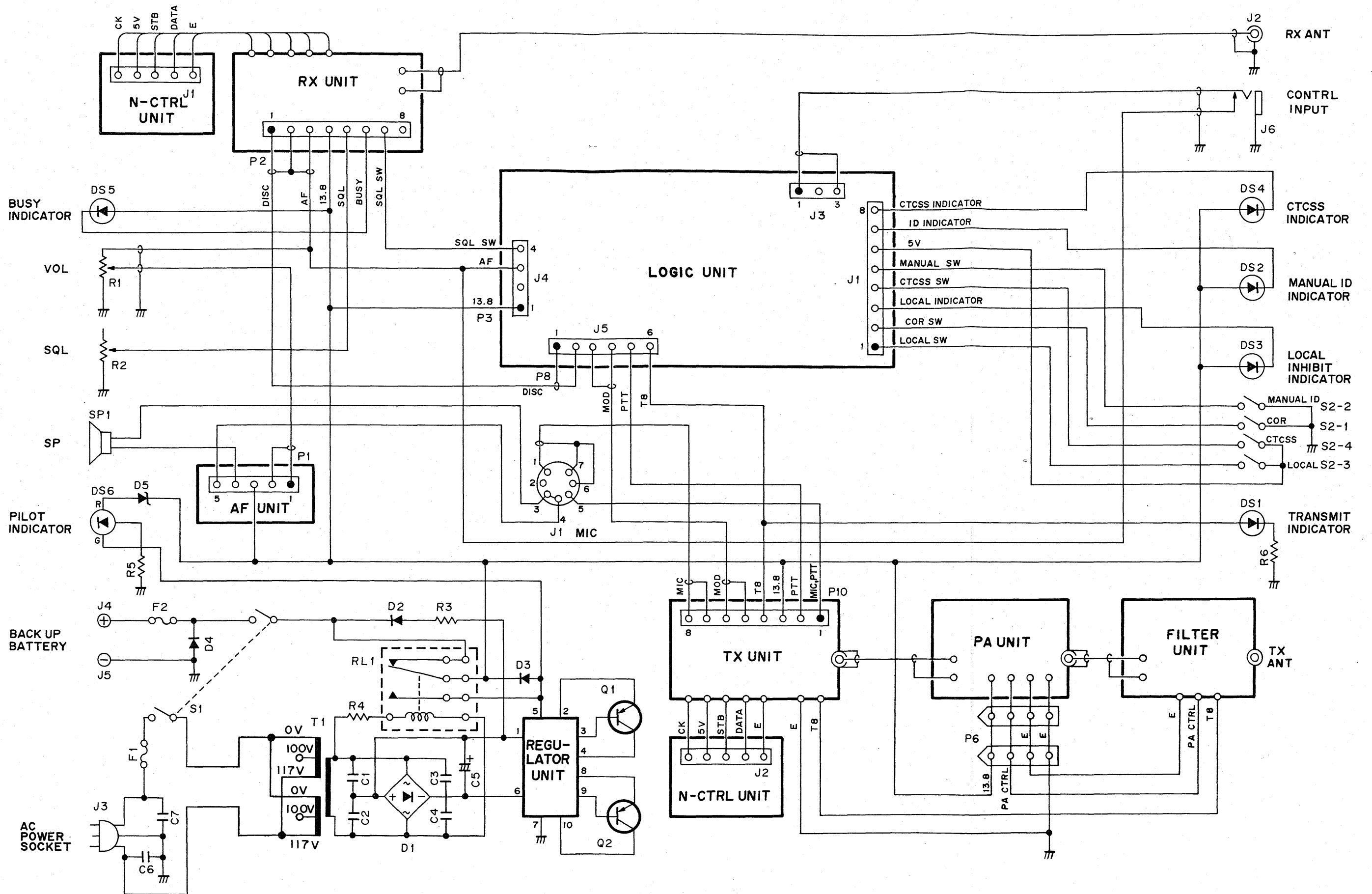

11. BLOCK DIAGRAM

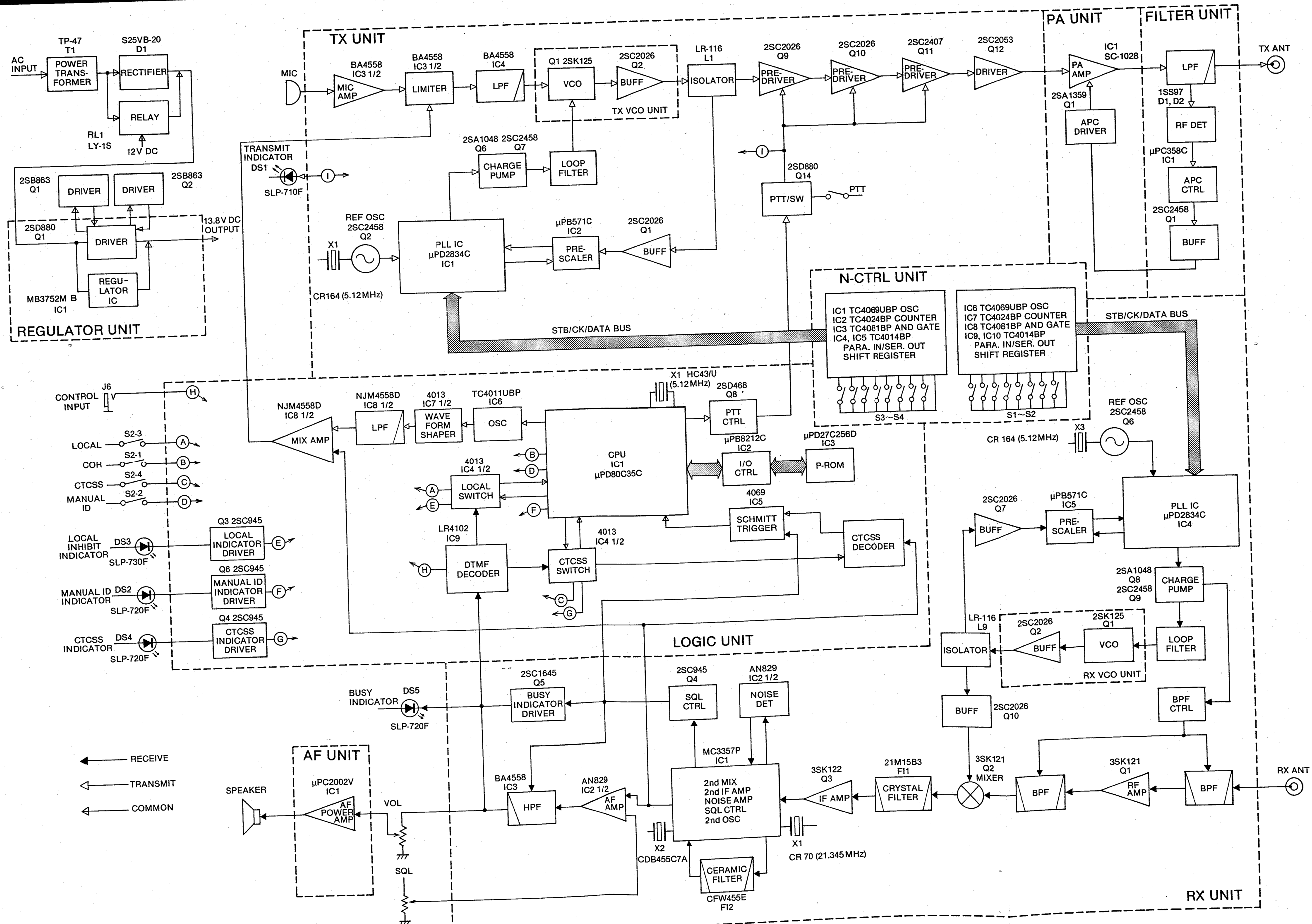

12. PARTS LIST

12-1 RX UNIT

REF NO.	DESCRIPTION	TYPE (PART NO.)
IC1	IC	MC3357P
IC2	IC	AN829
IC3	IC	BA4558
IC4	IC	μPD2834C
IC5	IC	μPB571C
IC6	IC	NJM7805A
IC7	IC	NJM7808A
Q1	FET	3SK121Y
Q2	FET	3SK121Y
Q3	FET	3SK122 K
Q4	Transistor	2SC945 K
Q5	Transistor	2SC1645 B
Q6	Transistor	2SC2458 GR
Q7	Transistor	2SC2026
Q8	Transistor	2SA1048 GR
Q9	Transistor	2SC2458 GR
Q10	Transistor	2SC2026
Q11	FET	2SK184 Y
Q12	Transistor	2SC3327 B
D1	Varicap	1SV153
D2	Varicap	1SV153
D3	Varicap	1SV153
D4	Varicap	1SV153
D5	Varicap	1SV153
D6	Varicap	1SV153
D7	Varicap	1SV153
D8	Varicap	1SV153
D9	Varicap	1SV153
D10	Varicap	1SV153
D11	Varicap	1SV153
D12	Varicap	1SV153
D13	Diode	1SS99
D14	Diode	1SS99
D15	Zener	RD6.2E B2
D16	Diode	1S953
D17	Diode	1S953
D18	Diode	1SS53
D19	Zener	RD5.1E B2
D20	Diode	1SS53
D21	Varicap	1SV50E (1)
D22	Zener	RD20E B2
D23	Diode	1SS133
D24	Diode	1SS133
D25	Diode	1SS130
FI1	Crystal	21M15B3
FI2	Ceramic	CFW455E
X1	Crystal	CR70
X2	Discriminator	CDB455C7A
X3	Crystal	CR164 (5.12MHz)
L1	Coil	LW-25
L2	Coil	LAL03NA R22M
L3	Coil	LA-234

RX UNIT

REF NO.	DESCRIPTION	TYPE (PART NO.)
L4	Coil	LS-297
L5	Coil	LS-298
L6	Coil	LS-297
L7	Coil	LA-235
L8	Coil	LAL03NA 101K
L9	Coil	LR-16
L10	Coil	LA-235
L11	Coil	LAL04NA 102K
L12	Coil	LW-30
R1	Resistor	100k ELR20
R2	Resistor	100k ELR20
R3	Resistor	47k R20
R4	Resistor	100 R20
R5	Resistor	100k ELR20
R6	Resistor	100k ELR20
R7	Resistor	100k ELR20
R8	Resistor	100k ELR20
R9	Resistor	470 ELR20
R10	Resistor	47k ELR20
R11	Resistor	2.2k R20
R12	Resistor	100 R20
R13	Resistor	470k R20
R14	Resistor	100k ELR20
R15	Resistor	120k ELR20
R16	Resistor	100 R20
R17	Resistor	10k R20
R18	Resistor	220 ELR20
R19	Resistor	47k R20
R20	Resistor	1.5k ELR20
R21	Resistor	1.5k ELR20
R22	Resistor	47k R20
R23	Resistor	1.5k R20
R24	Resistor	330k ELR20
R25	Resistor	47k ELR20
R26	Resistor	4.7k ELR20
R27	Resistor	22k ELR20
R28	Trimmer	3.3k RH0651CN3J01A
R29	Resistor	10k ELR20
R30	Resistor	100 R20
R31	Resistor	100 ELR20
R32	Resistor	47k ELR20
R33	Resistor	4.7k ELR20
R34	Resistor	100 R20
R35	Resistor	27k ELR20
R36	Resistor	10k ELR20
R37	Resistor	100 R20
R38	Resistor	4.7k ELR20
R39	Resistor	4.7k ELR20
R40	Resistor	680k ELR20
R41	Resistor	4.7k ELR20
R42	Resistor	100k R20
R43	Resistor	100k ELR20
R44	Resistor	10k ELR20
R45	Resistor	56k R20
R46	Resistor	6.8k ELR20
R47	Resistor	47k ELR20

RX UNIT

REF. NO.	DESCRIPTION	TYPE	(PART NO.)
R48	Resistor	47k	ELR20
R49	Resistor	22k	ELR20
R50	Resistor	560	R20
R51	Resistor	100	ELR20
R52	Resistor	120k	ELR20
R53	Resistor	2.2k	ELR20
R54	Resistor	68k	ELR20
R55	Resistor	6.8k	ELR20
R56	Thermistor	33D28	
R57	Resistor	2.2k	ELR20
R58	Resistor	10k	ELR20
R59	Thermistor	33D28	
R60	Resistor	15k	ELR20
R61	Resistor	330	ELR20
R62	Resistor	3.3k	ELR20
R63	Resistor	1.5k	ELR20
R64	Resistor	100k	ELR20
R65	Resistor	100k	ELR20
R66	Resistor	10k	ELR20
R67	Resistor	33k	ELR20
R68	Resistor	1k	ELR20
R69	Resistor	10k	ELR20
R70	Resistor	390	ELR20
R71	Resistor	120k	ELR20
R72	Resistor	10k	R20
R73	Resistor	10	ELR20
R74	Resistor	150	ELR20
R75	Resistor	33	ELR20
R76	Resistor	150	ELR20
R77	Resistor	330	ELR20
R78	Resistor	22	R20
R79	Resistor	330	R20
R80	Resistor	1.5k	ELR20
R81	Resistor	3.3k	ELR20
R82	Resistor	220	ELR20
R83	Resistor	100	ELR20
R84	Resistor	10k	ELR20
R85	Resistor	4.7k	ELR20
R86	Resistor	560	R20
R87	Resistor	100k	ELR20
R88	Resistor	100	ELR20
C1	Ceramic	5P	50V
C2	Trimmer	6P	CV38B0601
C3	Trimmer	10P	CV38D1001
C4	Ceramic	0.001	50V
C5	Ceramic	0.001	50V
C6	Ceramic	0.001	50V
C7	Trimmer	10P	CV38D1001
C8	Trimmer	10P	CV38D1001
C9	Trimmer	10P	CV38D1001
C10	Trimmer	10P	CV38D1001
C11	Trimmer	6P	CV38D0601
C12	Ceramic	0.001	50V
C13	Ceramic	0.001	50V
C14	Ceramic	0.001	50V
C15	Ceramic	0.001	50V
C16	Ceramic	0.001	50V
C17	Ceramic	0.001	50V
C18	Ceramic	0.001	50V
C19	Ceramic	0.001	50V

RX UNIT

REF. NO.	DESCRIPTION	TYPE	(PART NO.)
C20	Ceramic	7P	50V
C21	Ceramic	180P	50V
C22	Ceramic	62P	50V
C23	Ceramic	0.001	50V
C24	Ceramic	0.001	50V
C25	Ceramic	0.001	50V
C26	Ceramic	56P	50V
C27	Ceramic	68P	50V
C28	Barrier Layer	0.1	16V
C29	Barrier Layer	0.1	16V
C30	Ceramic	82P	50V
C31	Ceramic	0.001	50V
C32	Electrolytic	10	16V RC2
C33	Mylar	0.001	50V
C34	Ceramic	33P	50V
C35	Mylar	0.0022	50V
C36	Electrolytic	4.7	25V RC2
C37	Ceramic	0.0047	50V
C38	Mylar	0.001	50V
C39	Electrolytic	47	10V RC2
C40	Mylar	0.001	50V
C41	Electrolytic	3.3	50V RC2
C42	Ceramic	470P	50V
C43	Mylar	0.033	50V
C44	Electrolytic	0.47	50V RC2
C45	Electrolytic	4.7	25V RC2
C46	Barrier Layer	0.1	16V
C47	Mylar	0.001	50V
C48	Mylar	0.01	50V
C49	Mylar	0.01	50V
C50	Electrolytic	100	10V RE
C51	Mylar	0.01	50V
C52	Electrolytic	1	50V B.P
C53	Mylar	0.001	50V
C54	Electrolytic	3.3	50V RC2
C55	Mylar	0.01	50V
C56	Electrolytic	0.47	50V RC2
C57	Tantalum	0.1	35V DN
C58	Tantalum	0.33	35V DN
C59	Electrolytic	10	16V RC2
C60	Tantalum	0.1	35V DN
C61	Tantalum	0.33	35V DN
C62	Electrolytic	10	16V RC2
C63	Barrier Layer	0.01	25V
C64	Ceramic	100P	50V
C65	Ceramic	220P	50V
C66	Ceramic	0.001	50V
C67	Trimmer	20P	CV38D2001
C68	Ceramic	27P	50V CH
C69	Ceramic	4P	50V CH
C70	Ceramic	0.001	50V
C71	Electrolytic	47	6.3V RC2
C72	Ceramic	0.001	50V
C73	Ceramic	0.001	50V
C74	Ceramic	0.001	50V
C75	Ceramic	0.001	50V
C76	Ceramic	7P	50V
C77	Ceramic	82P	50V
C78	Ceramic	8P	50V
C79	Ceramic	100P	50V
C80	Barrier Layer	0.1	16V

RX UNIT

REF NO.	DESCRIPTION	TYPE (PART NO.)		
C81	Electrolytic	0.1	50V	RC2
C82	Electrolytic	22	25V	RE
C83	Barrier Layer	0.01	25V	
C84	Barrier Layer	0.1	16V	
C85	Barrier Layer	0.1	16V	
C86	Ceramic	47P	50V	
C87	Ceramic	0.001	50V	
C88	Ceramic	470P	50V	
C89	Ceramic	470P	50V	
C90	Ceramic	0.001	50V	
C91	Ceramic	0.001	50V	
C92	Electrolytic	47	6.3V	RC2
C93	Electrolytic	47	6.3V	RC2
C94	Electrolytic	3.3	50V	RC2
C95	Ceramic	6P	50V	
C96	Feed Through	TF318-450E102GMV50		
C97	Feed Through	TF318-450E102GMV50		
C98	Feed Through	TF318-450E102GMV50		
C99	Feed Through	TF318-450E102GMV50		
C100	Feed Through	TF318-450E102GMV50		
C101	Feed Through	TF318-450E102GMV50		
C102	Feed Through	TF318-450E102GMV50		
C103	Feed Through	TF318-450E102GMV50		
C104	Feed Through	TF318-450SL100G50		
C105	Feed Through	TF318-450E102GMV50		
C106	Feed Through	TF318-450SL100G50		
C107	Feed Through	TF318-450SL100G50		
C108	Feed Through	TF318-450E102GMV50		
C109	Resistor	0.1	16V	
C110	Ceramic	0.001	50V	
C111	Ceramic	470P	50V	
C112	Ceramic	0.001	50V	
C113	Ceramic	470P	50V	
J1	Connector	TMP-J01X-A2		
J2	Connector	TL-25P-05-V1		
J3	Connector	TL-25P-03-V1		
J4	Connector	TL-25P-06-V1		
J5	Connector	BNC-RM-106		
P1	Connector	TMP-P01X-A1		
P2	Connector	TL-25H-05-B1		
P3	Connector	TL-25H-03-B1		
P4	Connector	TL-25H-06-B1		
P5	Connector	SMR-09-VB		
P6	Connector	SMP-05-VB		
EP1	P.C. Board	B-1612A		

12-2 TX UNIT

REF NO.	DESCRIPTION	TYPE (PART NO.)	
IC1	IC	μPD2834C	
IC2	IC	μPB571C	
IC3	IC	BA4558	
IC4	IC	BA4558	
IC5	IC	NJM7808A	
IC6	IC	NJM7805A	
Q1	Transistor	2SC2026	
Q2	Transistor	2SC2458	GR
Q3	Transistor	2SC2458	GR
Q4	Transistor	2SC2458	GR
Q5	Transistor	2SC1815	Y
Q6	Transistor	2SA1048	GR
Q7	Transistor	2SC2458	GR
Q8	Transistor	2SC3327	B
Q9	Transistor	2SC2026	
Q10	Transistor	2SC2026	
Q11	Transistor	2SC2407	
Q12	Transistor	2SC2053	
Q13	Transistor	2SC945	P
Q14	Transistor	2SD880	Y
D1	Varicap	1SV50E (1)	
D2	Diode	1SS133	
D3	Diode	1SS133	
D4	Zener	RD20E	B2
D5	Diode	1SS130	
D6	Diode	1SS211	
D7	Diode	1SS53	
D8	Diode	1SS53	
D9	Zener	RD9.1E	B3
D10	Diode	1SS53	
X1	Crystal	CR-164 (5.12MHz)	
L1	Coil	LR-116	
L2	Coil	LA-235	
L3	Coil	LAL04NA 102K	
L4	Coil	LW-30	
L5	Coil	LAL03NA 101K	
L6	Coil	LA-235	
L7	Coil	LA-235	
L8	Coil	LA-235	
L9	Coil	LA-244	
L10	Coil	LA-252	
L11	Coil	LA-252	
L12	Coil	LAL04NA 2R7M	
R1	Resistor	10	ELR20
R2	Resistor	150	ELR20
R3	Resistor	33	ELR20
R4	Resistor	150	ELR20
R5	Resistor	1.5k	ELR20
R6	Resistor	3.3k	ELR20
R7	Resistor	330	ELR20
R8	Resistor	100	ELR20
R9	Resistor	120k	ELR20
R10	Resistor	2.2k	ELR20
R11	Resistor	68k	ELR20
R12	Resistor	6.8k	ELR20

TX UNIT

REF. NO.	DESCRIPTION	TYPE (PART NO.)	
R13	Thermistor	33D28	
R14	Resistor	2.2k	ELR20
R15	Resistor	10k	ELR20
R16	Thermistor	33D28	
R17	Resistor	15k	ELR20
R18	Resistor	47k	ELR20
R19	Resistor	39k	ELR20
R20	Resistor	33k	ELR20
R21	Resistor	120k	ELR20
R22	Resistor	10k	ELR20
R23	Resistor	390	ELR20
R24	Resistor	1k	ELR20
R25	Resistor	10k	ELR20
R26	Resistor	33k	ELR20
R27	Resistor	100k	ELR20
R28	Resistor	100k	ELR20
R29	Resistor	4.7k	ELR20
R30	Resistor	10k	ELR20
R31	Resistor	330	ELR20
R32	Resistor	22	R20
R33	Resistor	330	R20
R34	Resistor	3.3k	ELR20
R35	Resistor	1.5k	ELR20
R36	Resistor	220	ELR20
R37	Resistor	100	R20
R38	Resistor	1k	ELR20
R39	Resistor	3.3k	ELR20
R40	Resistor	1.8k	ELR20
R41	Resistor	150	ELR20
R42	Resistor	100	ELR20
R43	Resistor	27	ELR20
R44	Resistor	15k	ELR20
R45	Resistor	2.2k	ELR20
R46	Resistor	100	ELR20
R47	Resistor	68	R50X
R48	Resistor	1k	ELR20
R49	Resistor	18	ELR20
R50	Resistor	10k	ELR20
R51	Resistor	4.7k	ELR20
R52	Resistor	4.7k	ELR20
R53	Resistor	470k	ELR20
R54	Resistor	4.6k	ELR20
R55	Resistor	4.7k	ELR20
R56	Resistor	6.8k	ELR20
R57	Trimmer	4.7k	RH0651CS3J2KA
R58	Resistor	10k	ELR20
R59	Resistor	10k	ELR20
R60	Resistor	47k	ELR20
R61	Resistor	1M	ELR20
R62	Trimmer	4.7k	RH0651CS2J2KA
R63	Resistor	270k	ELR20
R64	Resistor	120k	ELR20
R65	Resistor	47k	ELR20
R66	Resistor	33k	ELR20
R67	Resistor	27k	ELR20
R69	Resistor	27k	ELR20
R70	Resistor	4.7k	ELR20
R71	Resistor	4.7k	ELR20
R72	Resistor	470	ELR20
R73	Resistor	10k	ELR20
R74	Resistor	47k	ELR20
R75	Resistor	1k	R20

TX UNIT

REF. NO.	DESCRIPTION	TYPE (PART NO.)	
C1	Ceramic	47P	50V
C2	Ceramic	8P	50V
C3	Ceramic	0.001	50V
C4	Ceramic	82P	50V
C5	Ceramic	7P	50V
C6	Ceramic	0.001	50V
C7	Ceramic	0.001	50V
C8	Barrier Layer	0.01	25V
C9	Ceramic	220P	50V
C10	Ceramic	100P	50V
C11	Ceramic	0.001	50V
C12	Trimmer	20P	CV38D2001
C13	Ceramic	27P	50V CH
C14	Ceramic	4P	50V CH
C15	Ceramic	0.001	50V
C16	Electrolytic	47	6.3V RC2
C17	Ceramic	0.001	50V
C18	Electrolytic	4.7	50V RC2
C19	Barrier Layer	0.1	16V
C20	Barrier Layer	0.01	25V
C21	Barrier Layer	0.1	16V
C22	Electrolytic	22	25V
C23	Mylar	0.0047	50V
C24	Barrier Layer	0.1	16V
C25	Ceramic	100P	50V
C26	Ceramic	0.001	50V
C27	Electrolytic	47	6.3V RC2
C28	Electrolytic	47	6.3V RC2
C29	Electrolytic	3.3	50V RC2
C30	Ceramic	0.001	50V
C31	Ceramic	470P	50V
C32	Ceramic	0.001	50V
C33	Ceramic	470P	50V
C34	Ceramic	10P	50V
C35	Ceramic	0.001	50V
C36	Ceramic	470P	50V
C37	Ceramic	470P	50V
C38	Ceramic	0.001	50V
C39	Ceramic	15P	50V
C40	Ceramic	0.001	50V
C41	Ceramic	470P	50V
C42	Ceramic	8P	50V
C43	Ceramic	4P	50V
C44	Ceramic	470P	50V
C45	Ceramic	0.001	50V
C46	Ceramic	0.001	50V
C47	Ceramic	470P	50V
C48	Ceramic	470P	50V
C50	Ceramic	10P	50V
C51	Ceramic	10P	50V
C52	Barrier Layer	0.1	16V
C53	Ceramic	470P	50V
C54	Ceramic	470P	50V
C55	Ceramic	470P	50V
C56	Ceramic	10P	50V
C57	Electrolytic	2.2	50V RC2
C58	Electrolytic	4.7	25V RC2
C59	Mylar	0.001	50V
C60	Ceramic	0.001	50V
C62	Mylar	0.001	50V
C63	Mylar	0.01	50V
C64	Ceramic	120P	50V

TX UNIT

REF. NO.	DESCRIPTION	TYPE (PART NO.)		
C65	Ceramic	10P	50V	
C66	Electrolytic	1	50V	RC2
C67	Barrier Layer	0.1	16V	
C68	Electrolytic	10	16V	RC2
C69	Ceramic	47P	50V	
C70	Ceramic	0.001	50V	
C71	Tantalum	0.1	35V	DN
C72	Tantalum	0.33	35V	DN
C73	Electrolytic	10	16V	RC2
C74	Tantalum	0.1	35V	DN
C75	Tantalum	0.33	35V	DN
C76	Electrolytic	10	16V	RC2
C77	Feed Through	TC318-450E102GMV50		
C78	Feed Through	TC318-450E102GMV50		
C79	Feed Through	TC318-450E102GMV50		
C80	Feed Through	TC318-450E102GMV50		
C81	Feed Through	TC318-450E102GMV50		
C82	Feed Through	TC318-450E102GMV50		
C83	Feed Through	TC318-450E102GMV50		
C84	Feed Through	TC318-450E102GMV50		
C85	Feed Through	TF318-450SL100G50		
C86	Feed Through	TF318-450E102GMV50		
C87	Feed Through	TF318-450SL100G50		
C88	Feed Through	TF318-450SL100G50		
C89	Feed Through	TF318-450E102GMV50		
C90	Feed Through	TF318-450E102GMV50		
C91	Feed Through	TF318-450E102GMV50		
J1	Connector	TMP-J01X-A2		
J2	Connector	TL-25P-08-V1		
J3	Connector	TL-25P-08-V1		
J4	Connector	BNC-RM-106		
P1	Connector	TMP-P01X-A1		
P2	Connector	TL-25H-08-B1		
P3	Connector	TL-25H-08-B1		
P4	Connector	SMR-08-VB		
P5	Connector	SMP-05-VB		
P6	Connector	SMP-03-VB		
EP1	P.C. Board	B-1533A		

12-3 RX-VCO UNIT

REF. NO.	DESCRIPTION	TYPE (PART NO.)		
Q1	FET	2SK125		
Q2	Transistor	2SC2026		
D1	Varicap	1SV50E (1)		
D4	Varicap	1SV153		
D5	Varicap	1SV50E (1)		
L1	Coil	LAL03NA 5R6M		
L2	Coil	LAL03NA 1R8M		
L4	Coil	LA-235		
L5	Coil	LAL03NA 3R3M		
L6	Coil	LAL03NA 3R3M		
L7	Coil	LAL03NA 3R3M		
R1	Resistor	680k	ELR20	
R2	Resistor	47k	ELR20	
R3	Resistor	4.7k	ELR20	
R4	Resistor	330k	ELR20	
R5	Resistor	10	ELR20	
R6	Resistor	1k	ELR20	
R7	Resistor	4.7k	ELR20	
R8	Resistor	5.6k	ELR20	
R9	Resistor	22	ELR20	
C1	Trimmer	20P	CV05D2001	
C2	Ceramic	4P	50V	
C3	Ceramic	4P	50V	
C4	Ceramic	3P	50V	
C5	Electrolytic	10	16V	RC3
C6	Ceramic	0.001	50V	
C7	Ceramic	0.001	50V	
C8	Electrolytic	22	16V	RC3
C9	Ceramic	3P	50V	
C10	Ceramic	0.001	50V	
C11	Ceramic	0.001	50V	
C12	Ceramic	0.001	50V	
C13	Ceramic	5P	50V	
EP1	P.C. Board	B-1101C		

12-4 TX-VCO UNIT

REF. NO.	DESCRIPTION	TYPE (PART NO.)	
Q1	FET	2SK125	
Q2	Transistor	2SC2026	
D1	Varicap	1SV50E (1)	
D4	Varicap	1SV153	
D5	Varicap	1SV50E (1)	
L1	Coil	LAL03NA 5R6M	
L2	Coil	LAL03NA 1R8M	
L4	Coil	LA-235	
L5	Coil	LAL03NA 3R3M	
L6	Coil	LAL03NA 3R3M	
L7	Coil	LAL03NA 3R3M	
R1	Resistor	680k	ELR20
R2	Resistor	47k	ELR20
R3	Resistor	4.7k	ELR20
R4	Resistor	10	ELR20
R5	Resistor	1k	ELR20
R6	Resistor	1k	ELR20
R7	Resistor	4.7k	ELR20
R8	Resistor	5.6k	ELR20
R9	Resistor	22	ELR20
C1	Trimmer	20P	CV05D2001
C2	Ceramic	4P	50V
C3	Ceramic	4P	50V
C4	Ceramic	3P	50V
C5	Electrolytic	10	16V RC3
C6	Ceramic	0.001	50V
C7	Ceramic	0.001	50V
C8	Electrolytic	22	16V RC3
C9	Ceramic	3P	50V
C10	Ceramic	0.001	50V
C11	Ceramic	0.001	50V
C12	Ceramic	0.001	50V
C13	Ceramic	5P	50V
EP1	P.C. Board	B-1101C	

12-5 LOGIC UNIT

REF. NO.	DESCRIPTION	TYPE (PART NO.)	
IC1	IC	μPD8035C	
IC2	IC	μPB8212C	
IC3	IC	μPD27C256D	
IC4	IC	4013	
IC5	IC	4049	
IC6	IC	TC4011UBP	
IC7	IC	4013	
IC8	IC	BA4558	
IC9	IC	LR4102	
IC10	IC	4049	
IC11	IC	4515	
IC12	IC	4044	
IC13	IC	4044	
IC14	IC	MN6520	
IC15	IC	BA4558	
IC16	IC	BA6993	
IC17	IC	NJM7805A	
Q1	Transistor	2SA1015	Y
Q2	Transistor	2SC945	P/Q
Q3	Transistor	2SC945	P/Q
Q4	Transistor	2SC945	P/Q
Q5	Transistor	2SC945	P/Q
Q6	Transistor	2SC945	P/Q
Q7	Transistor	2SC945	P/Q
Q8	Transistor	2SD468	C
Q9	Transistor	2SC1815	
Q10	Transistor	2SC1645	B
Q11	Transistor	2SC3399	
Q12	Transistor	2SC3399	
Q13	Transistor	2SA1015	Y
Q14	Transistor	2SC3399	
D1	Zener	RD8.2E	B3
D2	Diode	1SS53	
D3	Diode	1SS53	
D4	Diode	1SS53	
D5	Diode	1SS53	
D6	Diode	1SS53	
D7	Diode	1SS53	
D8	Diode	1SS53	
D9	Diode	1SS53	
D10	Diode	1SS53	
D11	Diode	1SS53	
D12	Diode	1SS53	
D13	Diode	1SS53	
D14	Diode	1SS53	
D15	Diode	1SS53	
D16	Diode	1SS53	
D17	Diode	1SS53	
D18	Diode	1SS53	
D19	Diode	1SS53	
D20	Diode	1SS53	
D21	Diode	1SS53	
X1	Crystal	HC43/U (5.120MHz)	
X2	Crystal	HC43/U (3.5795MHz)	
X3	Crystal	RF4A3 FAC (4.1943MHz)	
R1	Array	47k	RMX-8
R2	Resistor	22k	R20

LOGIC UNIT

REF. NO.	DESCRIPTION	TYPE	(PART NO.)
R3	Resistor	1k	ELR20
R4	Resistor	1k	R20
R5	Resistor	47k	ELR20
R6	Resistor	10k	R20
R7	Resistor	10	R20
R8	Resistor	47k	ELR20
R9	Resistor	47k	ELR20
R10	Resistor	47k	ELR20
R11	Resistor	47k	R20
R12	Resistor	47k	R20
R13	Resistor	47k	R20
R14	Resistor	1k	R20
R15	Resistor	10	R20
R16	Resistor	47k	ELR20
R17	Resistor	47k	ELR20
R18	Resistor	47k	R20
R19	Resistor	47k	R20
R20	Resistor	10k	R20
R21	Resistor	560	R20
R22	Resistor	22k	R20
R23	Resistor	10k	R20
R24	Resistor	10k	R20
R25	Resistor	22k	R20
R26	Resistor	560	R20
R27	Resistor	10k	R20
R28	Resistor	1k	R20
R29	Resistor	100	R20
R30	Resistor	100k	R20
R31	Resistor	10k	ELR20
R32	Resistor	22k	R20
R33	Resistor	47k	ELR20
R34	Resistor	10k	R20
R35	Resistor	100k	R20
R36	Resistor	10k	ELR20
R37	Resistor	220k	ELR20
R38	Trimmer	47k	RH0651CS4J25A
R39	Resistor	15k	R20
R40	Trimmer	47k	RH0651CS4J25A
R41	Resistor	18k	ELR20
R42	Resistor	18k	ELR20
R43	Resistor	47k	R20
R44	Resistor	220	R20
R45	Resistor	2.2k	ELR20
R46	Resistor	33k	R20
R47	Resistor	56k	ELR20
R48	Trimmer	10k	RH0651C14J2WA
R49	Resistor	10k	R20
R50	Resistor	10k	ELR20
R51	Resistor	1k	ELR20
R52	Resistor	220	ELR20
R53	Resistor	47k	ELR20
R54	Resistor	1k	R20
R55	Resistor	10M	ERC14GJ106
R56	Resistor	47k	R20
R57	Array	47k	RMX-10 473
R58	Resistor	10k	ELR20
R59	Resistor	10k	R20
R60	Resistor	15k	R20
R61	Resistor	10k	R20
R62	Resistor	150k	ELR20
R63	Resistor	2.2k	ELR20

LOGIC UNIT

REF. NO.	DESCRIPTION	TYPE	(PART NO.)
R64	Resistor	220k	ELR20
R65	Resistor	220k	R20
R66	Resistor	220k	ELR20
R67	Resistor	220k	ELR20
R68	Resistor	270k	ELR20
R69	Resistor	270k	ELR20
R70	Resistor	180k	R20
R71	Resistor	270k	R20
R72	Resistor	270k	R20
R73	Resistor	10k	ELR20
R75	Resistor	1k	ELR20
R76	Resistor	47k	R20
R77	Resistor	22k	R20
C1	Barrier Layer	0.1	16V
C2	Electrolytic	1	50V RC2
C3	Ceramic	22P	50V CH
C4	Ceramic	22P	50V CH
C5	Barrier Layer	0.1	16V
C6	Barrier Layer	0.1	16V
C7	Barrier Layer	0.1	16V
C8	Ceramic	0.001	50V
C9	Barrier Layer	0.1	16V
C10	Ceramic	0.001	50V
C11	Barrier Layer	0.047	25V
C12	Mylar	0.01	50V
C13	Barrier Layer	0.1	16V
C14	Mylar	0.1	50V
C15	Mylar	0.001	50V
C16	Electrolytic	47	16V RC2
C17	Electrolytic	100	10V RC2
C18	Electrolytic	47	16V RC2
C19	Barrier Layer	0.1	16V
C20	Barrier Layer	0.1	16V
C21	Barrier Layer	0.1	16V
C22	Mylar	0.01	50V
C23	Mylar	0.01	50V
C24	Mylar	0.01	50V
C25	Barrier Layer	0.1	16V
C26	Electrolytic	22	10V RC2
C27	Ceramic	18P	50V
C28	Ceramic	18P	50V
C29	Mylar	0.1	50V
C30	Electrolytic	47	16V RC2
C31	Barrier Layer	0.1	16V
C32	Electrolytic	0.47	50V RC2
C33	Mylar	0.01	50V
C34	Mylar	0.022	50V
C35	Ceramic	470P	50V
C36	Mylar	0.033	50V
C37	Barrier Layer	270P	50V
C38	Electrolytic	0.47	50V RC2
C39	Tantalum	0.1	35V DN
C40	Tantalum	0.33	35V DN
J1	Connector	TL-25P-04-V1	
J2	Connector	TL-25P-06-V1	
J3	Connector	TL-25P-03-V1	
J4	Connector	TL-25P-08-V1	
J5	Socket	IC30-2806-G4	

LOGIC UNIT

REF. NO.	DESCRIPTION	TYPE (PART NO.)
S1	Dip Switch	SSGM12
S2	Dip Switch	SSGM18
EP1	P.C. Board	B-1638B

12-6 N-CTRL UNIT

REF. NO.	DESCRIPTION	TYPE (PART NO.)
IC1	IC	TC4069UBP
IC2	IC	TC4024BP
IC3	IC	TC4081BP
IC4	IC	TC4014BP
IC5	IC	TC4014BP
IC6	IC	TC4069UBP
IC7	IC	TC4024BP
IC8	IC	TC4081BP
IC9	IC	TC4014BP
IC10	IC	TC4014BP
D1	Diode	1SS133
D2	Diode	1SS133
D3	Diode	1SS133
D4	Diode	1SS133
D5	Diode	1SS133
D6	Diode	1SS133
D7	Diode	1SS133
D8	Diode	1SS133
R1	Resistor	100k R20
R2	Resistor	10k R20
R3	Resistor	47k R20
R4	Resistor	22k R20
R5	Resistor	22k R20
R6	Array	47k RMX-8 473
R7	Array	47k RMX-8 473
R8	Resistor	100k R20
R9	Resistor	10k R20
R10	Resistor	47k R20
R11	Resistor	22k R20
R12	Resistor	22k R20
R13	Array	47k RMX-8 473
R14	Array	47k RMX-8 473
C1	Ceramic	470P 50V
C2	Barrier Layer	0.1 16V
C3	Barrier Layer	0.1 16V
C4	Barrier Layer	0.1 16V
C5	Ceramic	100P 50V
C6	Barrier Layer	0.1 16V
C7	Barrier Layer	0.1 16V
C8	Ceramic	100P 50V
C9	Ceramic	470P 50V
C10	Barrier Layer	0.1 16V
C11	Barrier Layer	0.1 16V
C12	Barrier Layer	0.1 16V
C13	Ceramic	100P 50V
C14	Barrier Layer	0.1 16V
C15	Barrier Layer	0.1 16V
C16	Ceramic	100P 50V
J1	Connector	TL-25P-05V1
J2	Connector	TL-25P-05V1
S1	Switch	SSGM18
S2	Switch	SSGM18
S3	Switch	SSGM18
S4	Switch	SSGM18
EP1	P.C. Board	B-1503A

12-7 PA UNIT

REF. NO.	DESCRIPTION	TYPE (PART NO.)	
IC1	IC	SC-1028	
Q1	Transistor	2SA1359	Y
C1	Ceramic	470P	50V
C2	Ceramic	0.001	50V
C3	Tantalum	10	35V DN
C4	Ceramic	470P	50V
C5	Ceramic	0.001	50V
C6	Electrolytic	10	16V MS7
J1	Connector	BNC-RM-106	
P1	Cable	OPC-035B	
P2	Connector	1460-4P1	
EP1	P.C. Board	B-1459	

12-8 FILTER UNIT

REF. NO.	DESCRIPTION	TYPE (PART NO.)	
IC1	IC	μPC358C	
Q1	Transistor	2SC2458	GR
D1	Diode	1SS97	
D2	Diode	1SS97	
L1	Coil	LA233	
L2	Coil	LA-252	
L3	Coil	LA-233	
L4	Coil	LA-252	
L5	Coil	LW-19	
R1	Resistor	330	R20
R1	Resistor	330	R20
R2	Resistor	100k	R20
R3	Resistor	10k	R20
R4	Resistor	100k	R20
R5	Resistor	2.2M	R20
R6	Resistor	56k	R20
R7	Resistor	4.7k	R20
R8	Resistor	15k	R20
R9	Trimmer	3.3k RH0651CN3J01A	
R10	Resistor	1.2k	R20
R11	Resistor	4.7k	R20
R12	Resistor	4.7k	R20
C1	Ceramic	0.001	50V
C2	Ceramic	0.001	50V
C3	Electrolytic	10	16V RC7
C4	Ceramic	0.001	50V
C5	Ceramic	0.001	50V
C6	Ceramic	0.001	50V
C7	Ceramic	3P	50V
C8	Ceramic	3P	50V
C9	Ceramic	3P	50V
C10	Ceramic	3P	50V
C11	Ceramic	27P	50V
C12	Ceramic	27P	50V
C13	Ceramic	0.001	500V
C14	Ceramic	22P	500V
C16	Ceramic	39P	500V
C18	Ceramic	33P	500V
C20	Ceramic	15P	500V
C21	Feed Through	TF240-602SS332Z50V	
C22	Feed Through	TF240-602SS332Z50V	
C23	Feed Through	TF240-602SS332Z50V	
C24	Ceramic	12P	500V
J1	Connector	MR-DS	
P1	Cable	OPC-035E	
EP1	P.C. Board	B-1502A	

12-9 AF UNIT

REF. NO.	DESCRIPTION	TYPE (PART NO.)	
IC1	IC	μPC2002V	
R1	Resistor	100	ELR20
R2	Resistor	4.7	ELR20
R3	Resistor	220	ELR20
R4	Resistor	4.7k	ELR20
C1	Electrolytic	220	16V
C2	Barrier Layer	0.1	16V
C3	Electrolytic	220	16V
C4	Electrolytic	100	16V
C5	Ceramic	0.0047	50V
C6	Electrolytic	0.47	50V
J1	Connector	TL-25P-05-V1	
EP1	P.C. Board	B-1611	

12-10 REGULATOR UNIT

REF. NO.	DESCRIPTION	TYPE (PART NO.)		
IC1	IC	MB3752M G		
Q1	Transistor	2SD880 Y		
R1	Resistor	2.2k	R20	
R3	Resistor	2.2k	R20	
R4	Trimmer	3.3k RH0652CN3J05A		
R5	Resistor	470	R20	
R6	Trimmer	330 RH0652CN2J04A		
R8	Resistor	470	R20	
R9	Resistor	100	R20	
R11	Resistor	0.03	SRW3P0.03-J	
R12	Resistor	0.03	SRW3P0.03-J	
R14	Resistor	1k	R20	
R16	Resistor	22	R20	
R17	Resistor	100	R20	
R18	Resistor	0.03	SRW3P0.03-J	
R19	Resistor	0.03	SRW3P0.03-J	
C1	Ceramic	0.001	50V	
C2	Electrolytic	470	16V	RE
C4	Electrolytic	470	25V	RE
J1	Connector	RT-01T-1.3B		
J2	Connector	RT-01T-1.3B		
J3	Connector	RT-01T-1.3B		
J4	Connector	RT-01T-1.3B		
J5	Connector	RT-01T-1.3B		
J6	Connector	RT-01T-1.3B		
J7	Connector	RT-01T-1.3B		
J8	Connector	RT-01T-1.3B		
J9	Connector	RT-01T-1.3B		
J10	Connector	RT-01T-1.3B		
EP1	P.C. Board	B-688E		

12-11 FRONT UNIT

REF. NO.	DESCRIPTION	TYPE (PART NO.)	
Q1	Transistor	2SB863	O/Y
Q2	Transistor	2SB863	O/Y
D1	Diode	S25VB20	
D2	Diode	1N4002	
D3	Diode	U05	B
D4	Diode	15CD11	
D5	Zener	RD3.0E	B2
R1	Variable	10k RK1631110D9DA 10KA	
R2	Variable	10k RK1631110D9CA 10KB	
R3	Resistor	SRW2P100-J	
R4	Resistor	SRW1P47J	
R5	Resistor	1k	R20
R6	Resistor	1k	R20
C1	Ceramic	0.01	50V
C2	Ceramic	0.01	50V
C3	Ceramic	0.01	50V
C4	Ceramic	0.01	50V
C5	Electrolytic	56000	25V
C6	Ceramic	0.001 DE7090B102K 400V	
C7	Ceramic	0.001 DE7090B102K 400V	
RL1	Relay	LY-1S	AC12V
J1	Connector	FM-14RS-7H	
J2	Connector	MR-DSE-02	
J3	Connector	CM-3	
J4	Terminal	T-3830	(red)
J5	Terminal	T-3830	(black)
J6	Connector	HSJ-296-01-150	
P1	Connector	TL-25H-05-B1	
P2	Connector	SMP-09-VB	
P3	Connector	TL-25H-04-B1	
P6	Connector	1490-4R	
P7	Connector	TL-25H-03-B1	
P8	Connector	TL-25H-06-B1	
P9	Connector	TL-25H-08-B1	
P10	Connector	SMP-08-VB	
P11	Connector	TL-25H-05-B1	
P12	Connector	SMR-05-VB	
P13	Connector	TL-25H-05-B1	
P14	Connector	SMR-05-VB	
P15	Connector	OPC-035F	
P16	Connector	SMR-03-VB	
F1	Fuse holder	DER FH-032C	(AC)
F2	Fuse holder	DER FH-032C	(DC)
DS1	LED	SLP-710F (red)	
DS2	LED	SLP-720F (green)	
DS3	LED	SLP-730F (yellow/red)	
DS4	LED	SLP-720F (green)	
DS5	LED	SLP-720F (green)	
DS6	LED	DB-18	

FRONT UNIT

REF. NO.	DESCRIPTION	TYPE (PART NO.)
S1	Switch	TWA-0068
S2	Switch	SPUE440F05A
T1	Transformer	TP-47
SP1	Speaker	C100P21A0001

12-12 MECHANICAL PARTS

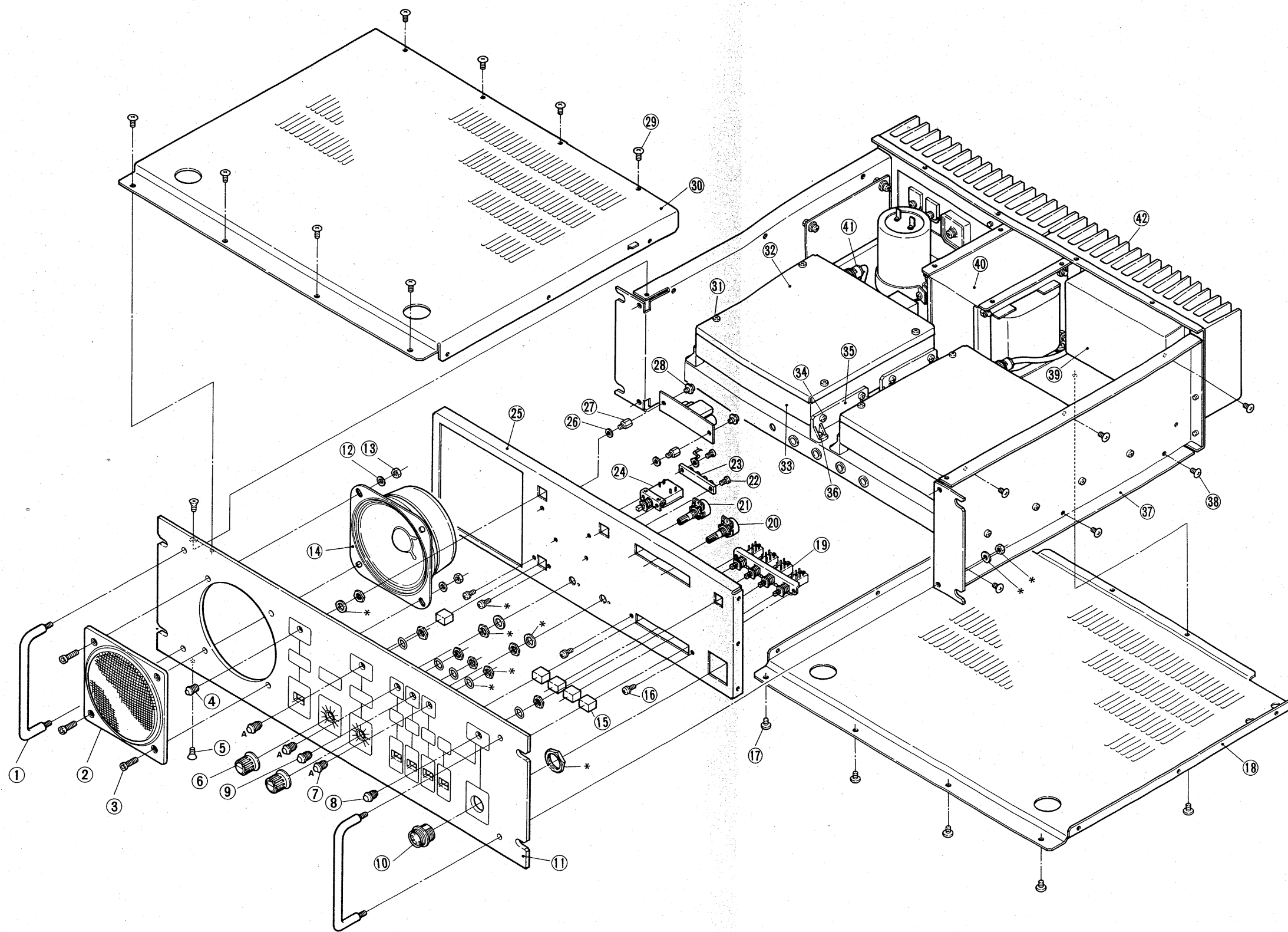

No.	PARTS NAME	PARTS NUMBER
1	Rack mounting handle	PH-110-8M
2	Speaker net	41925
3	Hex socket screw	M4 x 14 BLACK
4	LED	DB-18
5	Flat head screw	M3 x 6
6	Knob	N-66
7	LED	SLP-720F (green)
8	LED	SLP-710F (red)
9	LED	SLP-730F (yellow/red)
10	Mic connector	FM14RS-7H
11	Front panel (C)	C-02409
12	Flat washer	M4
13	Nut	M4
14	Speaker	C100P21A001
15	Button	UE201011
16	Set screw	(A) 3 x 6
17	ICOM screw	(A) 4
18	Bottom cover	20179
19	Switch	SPUE44F05A
20	Variable resistor	RK1631110D9CA 10KB
21	Variable resistor	RK1631110D9DA 10KA
22	Self-tapping screw	C0 M3 x 8
23	T-terminal	ML-3182 4P
24	Switch	TWA-0068-01-233
25	Sub-chassis	20162
26	Spring lock washer	M3
27	Stand-off (H)	L=7.5
28	Set screw	(C) 3 x 6
29	ICOM screw	(A) 4
30	Top cover	20178
31	Self-tapping screw	C0 M3 x 6
32	Shield case cover	42338
33	Shield case (A)	41699
34	Self-tapping screw	C0 M3 x 8
35	Support angle	41204
36	Set screw	(A) 3 x 8
37	Side panel (R)	20163
38	Self-tapping screw	C0 M3 x 6
39	PA cover	42339
40	Transformer	TP-47
41	BNC connector	BNC plug (Male)
42	PA heatsink	30322

* Parts marked with "*" are included with various assemblies (i.e., control pot, switch, LED, etc.).

13. SCHEMATIC AND VOLTAGE DIAGRAM

