



INSTRUCTION MANUAL

VHF FM REPEATER

IC-FR5000

IC-FR5100

UHF FM REPEATER

IC-FR6000

IC-FR6000-L

IC-FR6100



Thank you for choosing this Icom product. This product is designed and built with Icom's state of the art technology and craftsmanship. With proper care, this product should provide you with years of trouble-free operation.

◇ FEATURES

○ Up to 2 channels of operation

You can install a channel extension module (optional UR-FR5000/UR-FR5100/UR-FR6000/UR-FR6100) into a repeater. 2 channels can be operated on the same repeater when a channel extension module is installed.

○ Built-in 5-Tone, DTMF encoder & decoder

Multiple signaling systems are built-in as standard. These systems are fully compatible with Icom F-series radios.

○ DTMF remote control capability

You can control the repeater from a remote location over the air or over a phone line with DTMF.

○ D-Sub 25 pin ACC port equipped

You can use optional equipment through the D-sub 25 pin ACC port on the repeater's rear panel.

○ Online control and Digital Trunking operation

(May not be usable for some versions.) Online control and digital trunking operation are available when the optional UC-FR5000 trunking/network controller is installed in the repeater.

○ Other features

- Wide frequency coverage
 - <VHF>
 - IC-FR5000/IC-FR5100: 136 to 174 MHz
 - <UHF>
 - IC-FR6000: 350 to 400 MHz, 400 to 470 MHz, 450 to 512 MHz, 450 to 520 MHz
 - IC-FR6000-L: 350 to 400 MHz
 - IC-FR6100: 400 to 470 MHz
- PC programmable
- 19 inch rack mount
- Optional UT-109R/UT-110R VOICE SCRAMBLER UNIT for base operating mode

Icom is not responsible for the destruction or damage to the Icom repeater, if the malfunction is because of:

- Force majeure, including, but not limited to, fires, earthquakes, storms, floods, lightning, other natural disasters, disturbances, riots, war, or radioactive contamination.
- The use of Icom repeaters with any equipment that is not manufactured or approved by Icom.

IMPORTANT

READ THIS INSTRUCTION MANUAL CAREFULLY before attempting to operate the repeater.

SAVE THIS INSTRUCTION MANUAL— This manual contains important safety and operating instructions for the IC-FR5000/IC-FR5100/IC-FR6000/IC-FR6000-L/IC-FR6100 VHF/UHF FM REPEATERS.

EXPLICIT DEFINITIONS

WORD	DEFINITION
⚠ WARNING!	Personal injury, fire hazard or electric shock may occur.
CAUTION	Equipment damage may occur.
NOTE	If disregarded, inconvenience only. No risk of personal injury, fire or electric shock.

SUPPLIED ACCESSORIES

The following accessories are supplied.

Handles

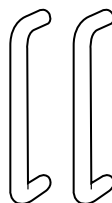

For handles attachment

Spacers



Screws



DC power cable (OPC-1784)

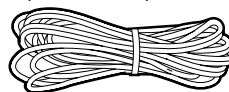

DC power cable (CAB-1149)*2

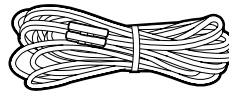

Function name stickers*1

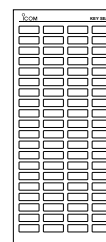

*1 Used for labelling the programmable function keys according to their assigned functions.

*2 Not supplied, depending on the repeater version.

Icom, Icom Inc. and the Icom logo are registered trademarks of Icom Incorporated (Japan) in Japan, the United States, the United Kingdom, Germany, France, Spain, Russia, Australia, New Zealand, and/or other countries. All other products or brands are registered trademarks or trademarks of their respective holders.

PRECAUTIONS

⚠ **WARNING HIGH VOLTAGE! NEVER** touch an antenna or internal antenna connector while transmitting. This could cause an electrical shock or RF burn.

⚠ **WARNING HIGH VOLTAGE! NEVER** install the antenna at any place that person easily touch the antenna while transmitting. This could cause an electrical shock or RF burn.

⚠ **WARNING! NEVER** apply AC power to the DC power receptacle on the repeater rear panel. This could cause a fire or damage the repeater.

⚠ **WARNING! NEVER** apply more than 16 V DC to the DC power receptacle on the repeater rear panel. This could cause a fire or damage the repeater.

⚠ **WARNING! NEVER** reverse the DC power cable polarity. This could cause a fire or damage the repeater.

⚠ **WARNING! NEVER** let metal, wire or other objects contact the inside of the repeater, or make incorrect contact with connectors on the rear panel. This could cause an electric shock or damage the repeater.

CAUTION: DO NOT use or leave the repeater in areas with temperatures below -30°C (-22°F) or above $+60^{\circ}\text{C}$ ($+140^{\circ}\text{F}$), or below -25°C (-13°F) or above $+55^{\circ}\text{C}$ ($+131^{\circ}\text{F}$) for the European versions. Be aware that temperatures can exceed 80°C ($+176^{\circ}\text{F}$), resulting in permanent damage to the repeater if left there for extended periods.

CAUTION: DO NOT place or leave the repeater in excessively dusty environments. This could damage the transceiver.

CAUTION: DO NOT put anything on top of the repeater. This will obstruct heat dissipation.

CAUTION: DO NOT set the repeater's RF output power to more than your external linear amplifier's maximum input level, if you use one. Otherwise, a high input could damage the linear amplifier.

CAUTION: DO NOT use non-Icom microphones. Other manufacturer's microphones may have different pin assignments, and could damage the connector and/or the transceiver.

NEVER expose the repeater to rain, snow or any liquids.

NEVER place the repeater in an insecure place to avoid inadvertent use by unauthorized persons.

BE CAREFUL! The heatsink will become hot when continuously operating the repeater for long periods of time.

For U.S.A. only

CAUTION: Changes or modifications to this repeater, not expressly approved by Icom Inc., could void your authority to operate this repeater under FCC regulations.

TABLE OF CONTENTS

IMPORTANT.....	i
EXPLICIT DEFINITIONS.....	i
SUPPLIED ACCESSORIES.....	i
PRECAUTIONS.....	ii
SAFETY TRAINING INFORMATION	iii
INFORMATION SUR LA FORMATION	
À LA SÉCURITÉ	iii
FCC INFORMATION	iv
INFORMATIONS FCC.....	iv
VOICE CODING TECHNOLOGY	iv

1. PANEL DESCRIPTION	1
■ Front panel.....	1
◇ Function display	2
■ Rear panel	2
◇ Accessory connector.....	3
2. INSTALLATION AND CONNECTIONS	4
■ Unpacking.....	4
■ Selecting a location.....	4
■ Antenna connection	4
■ Front panel connection	5
■ Rear panel connection.....	5
■ Power supply connection	6
■ Mounting the repeater.....	6
◇ Using the supplied handles.....	6
■ Fuse replacement.....	6
◇ Line fuse replacement.....	6
■ Receiving and transmitting	7
◇ Repeater operation	7
◇ Base station operation	7
3. OPERATION	7
4. MAINTENANCE AND OPTIONS.....	8
■ Troubleshooting.....	8
■ Options	8
5. ABOUT CE.....	9
■ ABOUT CE AND DOC.....	10
■ DISPOSAL.....	10

For European versions



CAUTION: Hot surfaces. **DO NOT** touch the repeater's surface after continuously transmitting for long periods of time. The repeater's chassis radiates heat, and it will become hot to protect the power amplifier unit from overheating. Touching it may cause a burn.

SAFETY TRAINING INFORMATION



Your Icom radio generates RF electromagnetic energy during transmit mode. This radio is designed for and classified as “Occupational Use Only,” meaning it must be used only during the course of employment by individuals aware of the hazards, and the ways to minimize such hazards.

This radio is **NOT** intended for use by the “General Population” in an uncontrolled environment.

- For compliance with FCC and IC RF Exposure Requirements, the transmitter antenna installation shall comply with the following three conditions:
 1. The transmitter antenna gain shall not exceed 0 dBi.
 2. IC-FR5000:
Transmit only when people are at least the recommended minimum distance of 141 centimeters away from the properly installed antenna. This separation distance will ensure that there is sufficient distance from a properly installed externally-mounted antenna to satisfy the RF exposure requirements in the applicable RF exposure compliance standards.
 2. IC-FR6000/IC-FR6000-L:
Transmit only when people are at least the recommended minimum distance of 122 centimeters away from the properly installed antenna. This separation distance will ensure that there is sufficient distance from a properly installed externally-mounted antenna to satisfy the RF exposure requirements in the applicable RF exposure compliance standards.



To ensure that your exposure to RF electromagnetic energy is within the FCC and IC allowable limits for occupational use, always adhere to the following guidelines:

- **DO NOT** operate the radio without a proper antenna attached, as this may damage the radio and may also cause you to exceed FCC and IC RF exposure limits. A proper antenna is the antenna supplied with this radio by the manufacturer or an antenna specifically authorized by the manufacturer for use with this radio.
- **DO NOT** transmit for more than 50% of total radio use time (“50% duty cycle”). Transmitting more than 50% of the time can cause FCC and IC RF exposure compliance requirements to be exceeded. The radio is transmitting when the “TX indicator” lights red. You can cause the radio to transmit by pressing the “PTT” switch.

Electromagnetic Interference/Compatibility

During transmissions, your Icom radio generates RF energy that can possibly cause interference with other devices or systems. To avoid such interference, turn off the radio in areas where signs are posted to do so. **DO NOT** operate the transmitter in areas that are sensitive to electromagnetic radiation such as hospitals, aircraft, and blasting sites.

INFORMATION SUR LA FORMATION À LA SÉCURITÉ



Votre radio Icom produit une énergie électromagnétique de radiofréquences (RF), en mode de transmission. Cette radio est conçue pour un «usage professionnel seulement» et classée comme tel, ce qui signifie qu'elle doit être utilisée uniquement dans le cadre d'un travail par des personnes conscientes des dangers et des mesures visant à minimiser ces dangers. Elle **N'EST PAS** conçue pour une «utilisation grand public», dans un environnement non contrôlé.

- Afin de satisfaire aux exigences de la FCC et d'IC en matière d'exposition aux RF, il est nécessaire que l'antenne soit installée conformément aux trois conditions suivantes:
 1. Le gain de l'antenne du radio émetteur ne doit pas dépasser 0 dBi.
 2. IC-FR5000:
Transmettre que lorsque les gens sont au moins la distance minimale recommandée de 141 centimètres de l'antenne est correctement installé. Cette distance de sécurité assurera que les personnes soient placées suffisamment loin d'une antenne correctement fixée à l'extérieur pour satisfaire aux exigences en matière d'exposition aux RF, en vertu des normes de conformité applicables.
 2. IC-FR6000/IC-FR6000-L:
Transmettre que lorsque les gens sont au moins la distance minimale recommandée de 122 centimètres de l'antenne est correctement installé. Cette distance de sécurité assurera que les personnes soient placées suffisamment loin d'une antenne correctement fixée à l'extérieur pour satisfaire aux exigences en matière d'exposition aux RF, en vertu des normes de conformité applicables.



Afin de vous assurer que votre exposition à une énergie électromagnétique de RF se situe dans les limites permises par la FCC et d'IC pour une utilisation grand public, veuillez en tout temps respecter les directives suivantes:

- **NE PAS** faire fonctionner la radio sans qu'une antenne appropriée y soit fixée, car ceci risque d'endommager la radio et causer une exposition supérieure aux limites établies par la FCC et d'IC. L'antenne appropriée est celle qui est fournie avec cette radio par le fabricant ou une antenne spécialement autorisée par le fabricant pour être utilisée avec cette radio.
- **NE PAS** émettre pendant plus de 50% du temps total d'utilisation de l'appareil («50% du facteur d'utilisation»). Émettre pendant plus de 50% du temps total d'utilisation peut causer une exposition aux RF supérieure aux limites établies par la FCC et d'IC. Lorsque le voyant DEL rouge s'allume, cette radio est en train d'émettre. La radio émettra si vous appuyez sur le bouton du microphone.

Interférence électromagnétique et compatibilité

En mode de transmission, votre radio Icom produit de l'énergie de RF qui peut provoquer des interférences avec d'autres appareils ou systèmes. Pour éviter de telles interférences, mettez la radio hors tension dans les secteurs où une signalisation l'exige. **NE PAS** faire fonctionner l'émetteur dans des secteurs sensibles au rayonnement électromagnétique tels que les hôpitaux, les aéronefs et les sites de dynamitage.

FCC INFORMATION

This equipment has been tested and found to comply with the limits for a Class A digital device, pursuant to part 15 of the FCC Rules. These limits are designed to provide reasonable protection against harmful interference when the equipment is operated in a commercial environment. This equipment generates, uses, and can radiate radio frequency energy and, if not installed and used in accordance with the instruction manual, may cause harmful interference to radio communications. Operation of this equipment in a residential area is likely to cause harmful interference in which case the user will be required to correct the interference at his own expense.

INFORMATIONS FCC

Cet équipement a été testé et reconnu conforme aux limites fixées pour un appareil numérique de classe A, conformément au point 15 de la réglementation FCC. Ces limites assurent une protection raisonnable contre les interférences nuisibles lorsque l'équipement est utilisé dans un environnement commercial. Cet équipement génère une énergie de radio fréquence, utilise et rayonne et s'il n'est pas installé et utilisé conformément au manuel d'instruction, peut causer des interférences nuisibles aux communications radio. Le fonctionnement de cet équipement dans une zone résidentielle est susceptible de causer des interférences nuisibles lorsque l'utilisateur doit corriger les interférences à ses propres frais.

VOICE CODING TECHNOLOGY

The AMBE+2™ voice coding Technology embodied in this product is protected by intellectual property rights including patent rights, copyrights and trade secrets of Digital Voice Systems, Inc. This voice coding Technology is licensed solely for use within this Communications Equipment.

The user of this Technology is explicitly prohibited from attempting to extract, remove, decompile, reverse engineer, or disassemble the Object Code, or in any other way convert the Object Code into a human-readable form. U.S. Patent Nos.

#8,595,002, #8,359,197, #8,315,860, #8,200,497, #7,970,606, and #6,912,495 B2.

Front panel

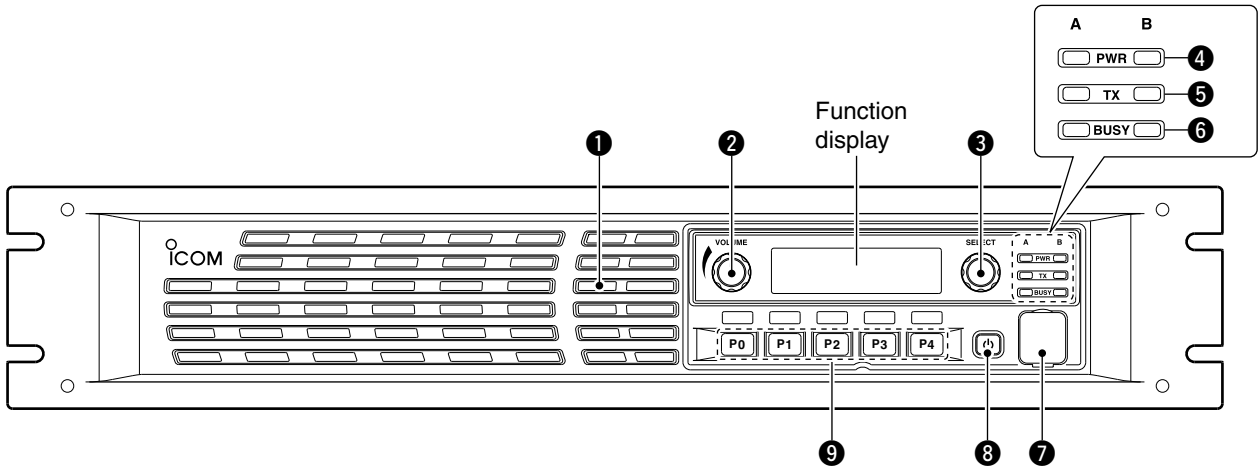

1 INTERNAL SPEAKER

Outputs the received audio.

2 VOLUME CONTROL [VOLUME] (p. 7)

Adjusts the audio output level.

3 SELECTOR DIAL [SELECT]

Rotate to adjust the squelch threshold level, select the operating channel. (Depending on the presetting.)

4 POWER INDICATOR [POWER]

➔ Lights green at 'A' module's indicator while the repeater power is turned ON.

When a channel extension module is installed:

➔ Lights green at the selected module indicator ('A' or 'B') while the repeater power is turned ON.

➔ Lights orange at the un-selected module indicator ('A' or 'B') while the repeater power is turned ON.

5 TRANSMIT INDICATOR [TX]

Lights red while transmitting.

6 BUSY INDICATOR [BUSY]

Lights green while receiving a signal or when the noise squelch is open.

About [PWR], [TX] and [BUSY] indicators:

'A' and 'B' modules indicators are usable for these indications. 'A' module's indicator corresponds to the original module, and 'B' module's indicator corresponds to an extended module.

7 MICROPHONE CONNECTOR [MIC]

This 8-pin modular jack accepts an optional microphone.

KEEP the [MIC] connector cover attached to the repeater when an optional microphone is not used.

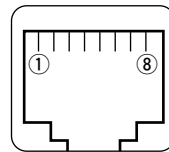

(Front panel view)

- ① +8 V DC output (Max. 15 mA)
- ② Output port for PC programming
- ③ NC
- ④ M PTT (Input port for TX control)
- ⑤ Microphone ground
- ⑥ Microphone input
- ⑦ Ground
- ⑧ Input port for PC programming

8 POWER SWITCH [POWER]

➔ Push to turn ON the repeater power.

➔ Hold down for 3 seconds to turn OFF the repeater power.

When a channel extension module is installed:

➔ While the repeater power is turned ON, push to select the desired module to operate the repeater as the base station.

- The power indicator of the selected module unit lights green.

9 DEALER-PROGRAMMABLE KEYS

Desired functions can be independently preset by your dealer.

Ask your dealer for details.

- Because these keys are programmable, the functions are unique to each unit.

◇ **Function display**

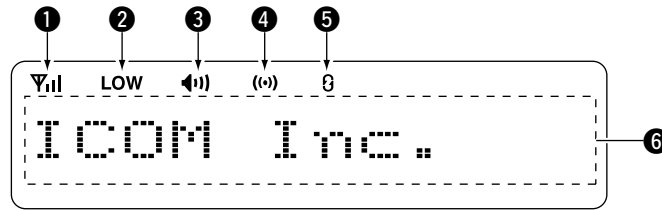

1 SIGNAL STRENGTH INDICATOR

Indicates relative signal strength level.

2 LOW POWER INDICATOR

Appears when low output power is selected.

3 AUDIBLE INDICATOR

Appears when the channel is in the 'audible' (unmute) mode.

4 COMPANDER INDICATOR

Appears when the compander function is activated.

5 SCRAMBLER/ENCRYPTION INDICATOR

Appears when the voice scrambler/encryption function is activated.

6 ALPHANUMERIC DISPLAY

Shows a variety of text or code information.

■ **Rear panel**

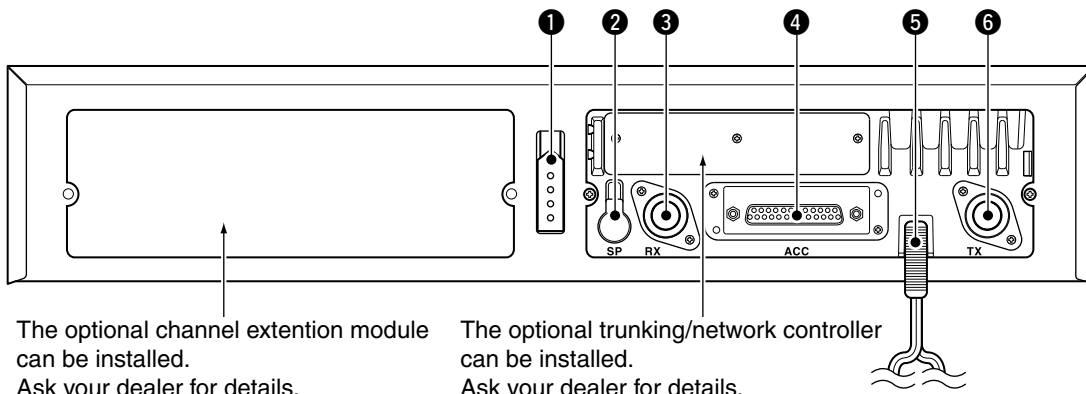

The optional channel extension module can be installed. Ask your dealer for details.

The optional trunking/network controller can be installed. Ask your dealer for details.

The repeater rear panel may be different, depending on the repeater's version.

1 DC POWER CONNECTOR (For cooling fans)

(May not be installed, depending on the repeater version.)

Connects to the supplied CAB-1149 DC power cable from this connector to an external DC power source to activate the cooling fans. See page 5 for the connection details.

2 EXTERNAL SPEAKER CONNECTOR [SP]

Connects to the optional SP-35.

3 RECEIVE ANTENNA CONNECTOR [RX]

Connects to a receive antenna (impedance: 50 Ω).

4 ACCESSORY CONNECTOR [ACC]

Connects to the accessory connector.

• See page 3 for accessory connector information.

5 DC POWER RECEPTACLE

Connects to the supplied OPC-1784 DC power cable from an external DC power source. See page 5 for the connection details.

6 TRANSMIT ANTENNA CONNECTOR [TX]

Connects to a transmit antenna (impedance: 50 Ω).

1 PANEL DESCRIPTION

◇ Accessory connector

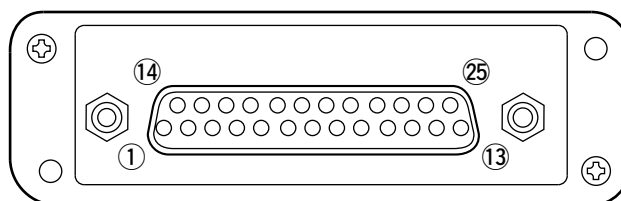

Pin No.	Pin Name	Description	Specification
1	NC	No connection	—
2	TXD	Output terminal for serial communication data.	—
3	RXD	Input terminal for serial communication data.	—
4	RTS	Output terminal for request-to-send data.	—
5	CTS	Input terminal for clear-to-send data.	—
6	NC	No connection	—
7	GND	Serial/digital signal ground	—
8	MOD IN	Modulator input from an external terminal unit.	Input level: 300 mV rms* ²
9	DISC OUT	Output terminal for AF signals from the AF detector circuit. Output level is fixed, regardless of the [AF] control setting.	Output level: 300 mV rms * ³
10	EXT. D/A	Function assignable.* ¹ (Default: Null)	—
11	VCC	DC output	Output current: Less than 1 A
12	EXT. A/D	Customize A/D input (Not used)	—
13	NC	No connection	—
14	GND	Ground	—
15	EXT./O 15	Function assignable.* ¹ (Default: Null)	+5 V pull up, Active=L
16	EXT./O 16	Function assignable.* ¹ (Default: P0 Monitor Output)	+5 V pull up, Active=L
17	EXT./O 17	Function assignable.* ¹ (Default: Busy Output)	+5 V pull up, Active=L
18	EXT./O 18	Function assignable.* ¹ (Default: Null)	+5 V pull up, Active=L
19	EXT./O 19	Function assignable.* ¹ (Default: EPTT Input)	+5 V pull up, Active=L
20	DATA IN	Input terminal for data. Frequency characteristics are flat.	Input level: 300 mV rms* ⁴
21	EXT./O 21	Function assignable.* ¹ (Default: Analog Audible Output)	+5 V pull up, Active=L
22	AF OUT	The AF detector Output.	—
23	EXT./O 23	Function assignable.* ¹ (Default: Mic Mute Output)	+5 V pull up, Active=L
24	EXT./O 24	Function assignable.* ¹ (Default: Null)	+5 V pull up, Active=L
25	EXT./O 25	Function assignable.* ¹ (Default: Mic Hanger Output)	+5 V pull up, Active=L

*¹ The desired function can be assigned using the optional CS-FR5000 CLONING SOFTWARE. Ask your dealer for details.

*² (For the European versions) Input impedance: 2.7 k Ω Input level: 85 mV rms (for 60% deviation)

NOTE: If the input impedance is changed to 27 k Ω , a 300 mV rms input level is needed for 60% deviation signal.

*³ (For the European versions) Output level: 300 mV rms. Received 60% deviation signal.

*⁴ (For the European versions) Input impedance: 47 k Ω Input level: 300 mV rms (for 60% deviation)

■ Unpacking

After unpacking, immediately report any damage to the delivering carrier or dealer. Keep the shipping cartons.

For a description and a diagram of accessory equipment included with the repeater, see 'SUPPLIED ACCESSORIES' on page i of this manual.

■ Selecting a location

Select a location for the repeater that allows adequate air circulation, free from extreme heat, cold, or vibrations, and away from TV sets, TV antenna elements, radios and other electromagnetic sources.

■ Antenna connection

For radio communications, the antenna is a critical component, along with output power and sensitivity. Select antenna(s), such as a well-matched 50 Ω antenna, and feedline. 1.5:1 or better of Voltage Standing Wave Ratio (VSWR) is recommended for the desired band. Of course, the transmission line should be a coaxial cable.

CAUTION: DO NOT install the repeater without a lightning arrestor to help protect the repeater from lightning.

NOTE: There are many publications that describe proper antennas and their installation. Check with your local dealer for more information and recommendations.

1

2

TYPE-N CONNECTOR INSTALLATION EXAMPLE

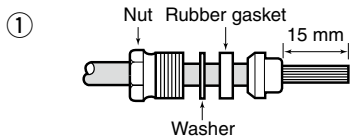

Slide the nut, flat washer, rubber gasket and clamp over the coaxial cable, then cut the end of the cable evenly.

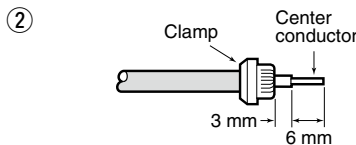

Strip the cable and fold the braid back over the clamp.

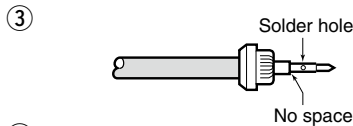

Soft solder the center conductor. Install the center conductor pin and solder it.

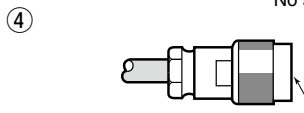

Carefully slide the plug body into place aligning the center conductor pin on the cable. Tighten the nut onto the plug body.

Be sure the center conductor is the same height as the plug body.

15 mm (0.59 in) 6 mm (0.24 in) 3 mm (0.12 in)

■ Front panel connection

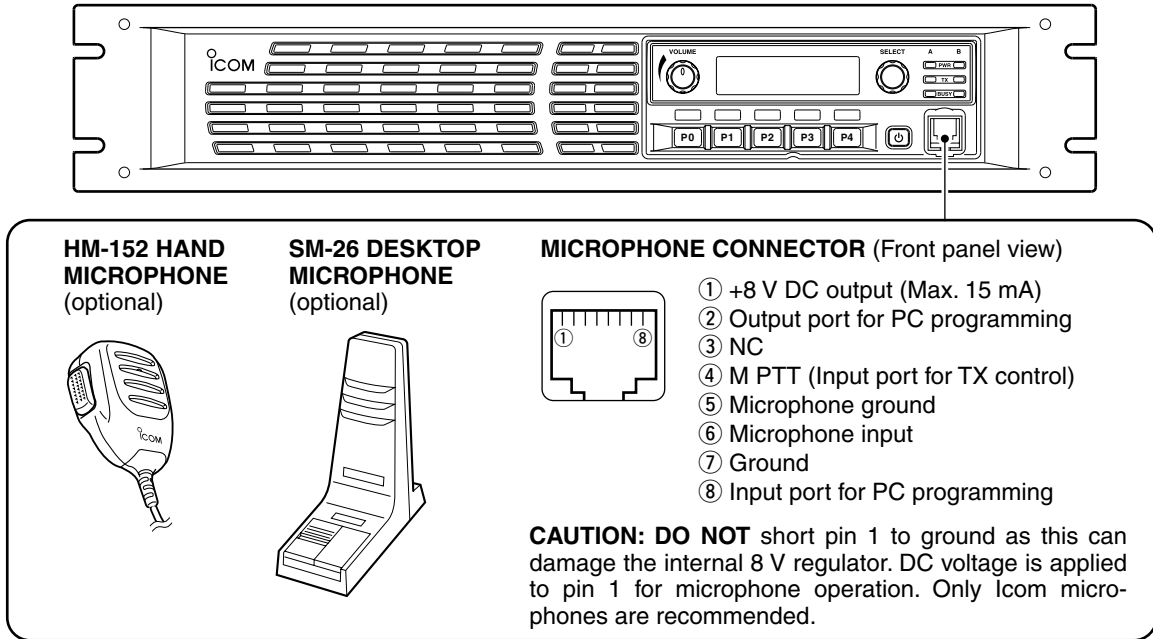

■ Rear panel connection

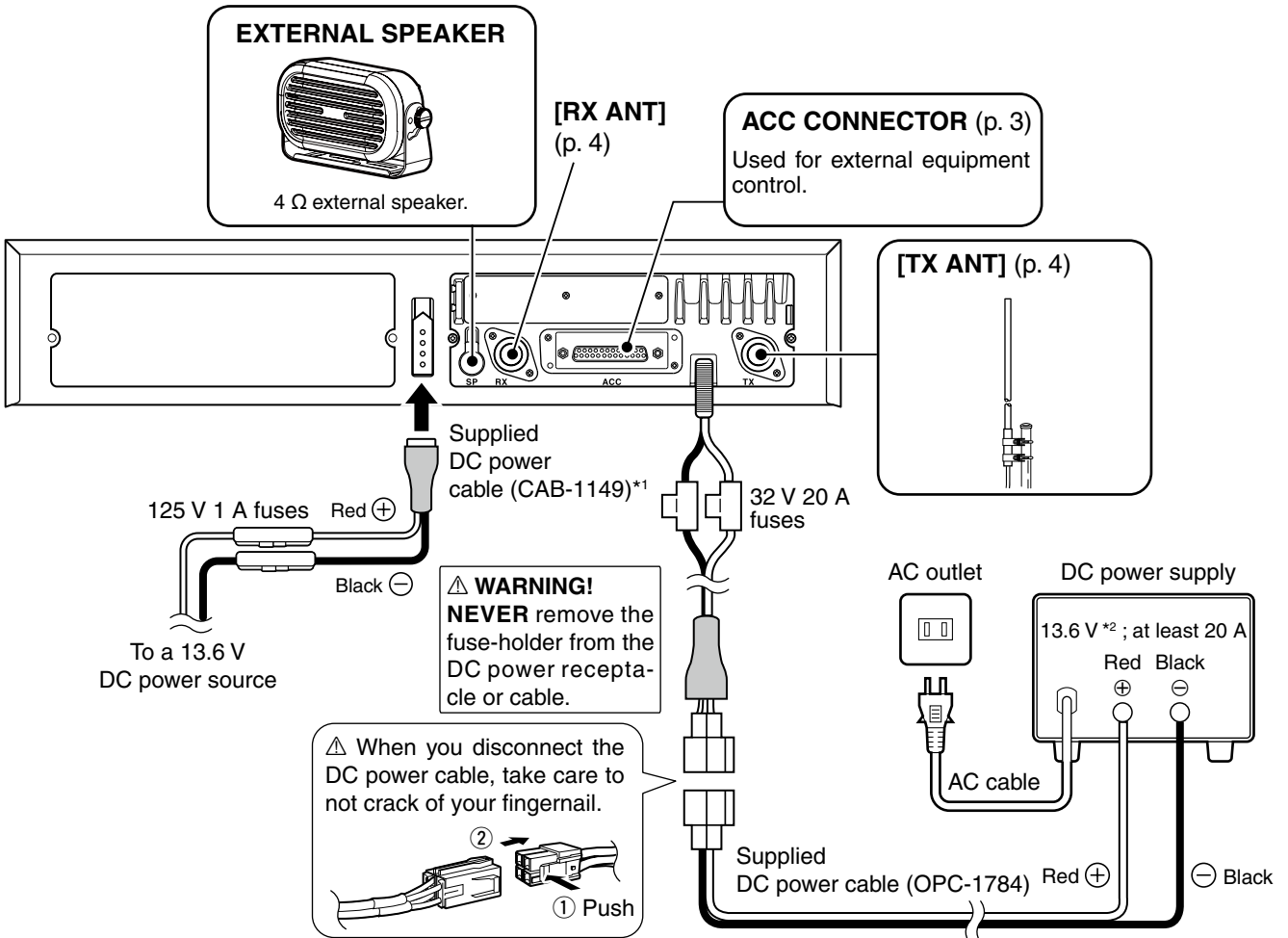

*1 This connection may not be required, depending on the repeater version. The repeater rear panel may be different, depending on the repeater version.
 *2 13.2 V for the European versions.

■ Power supply connection

Make sure the repeater's power is turned OFF when connecting a DC power cable.

⚠ WARNING! NEVER apply more than 16 V DC to the DC power receptacle on the repeater rear panel. This could cause a fire or damage the repeater.

■ Mounting the repeater

◇ Using the supplied handles

The supplied handles are used when mounting the repeater into a 19 inch rack. The handles are installed on the repeater's front panel.

- ① Attach the supplied handles to both sides of the repeater's front panel with the spacers, then tighten the screws as shown below.

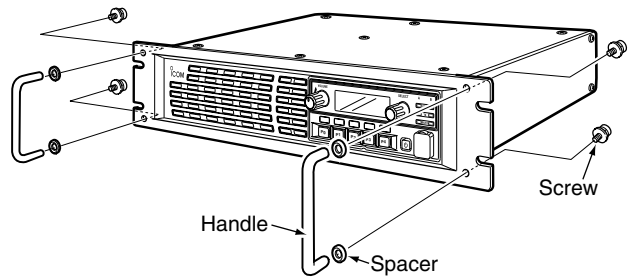

- ② The completed installation should look like the illustration below.

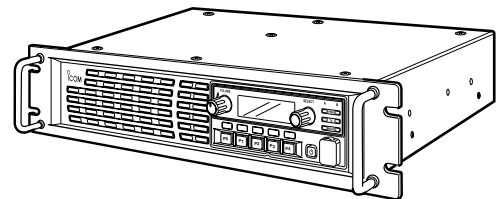

■ Fuse replacement

If a fuse blows, or the repeater stops functioning, find the source of the problem, repair it and then replace the damaged fuse with a new rated one.

⚠ CAUTION: DO NOT replace the fuse with the DC power cable connected to the repeater. Disconnect the cable to prevent electric shock and/or equipment damage.

◇ Line fuse replacement

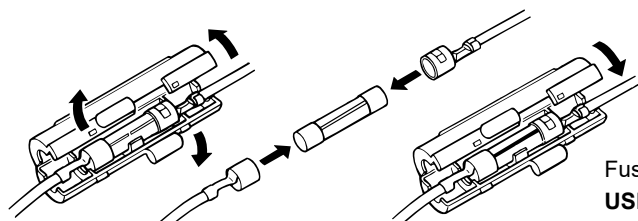
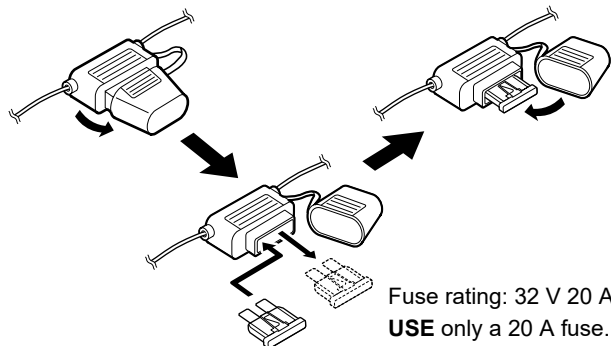

Fuse rating explanation

Fuse coding: FUSE 32 V 20 A
 Fuse voltage rating: 32 Volts
 Fuse current rating: 20 Amperes

■ Receiving and transmitting

◇ Repeater operation

Ask your dealer for details of the repeater's presettings.

- When the power is turned ON, the **[PWR]** indicator lights green. (p. 1)
- The **[TX]** or **[BUSY]** indicator lights simultaneously while transmitting/receiving a signal.
 - The **[TX]** indicator lights red.
 - The **[BUSY]** indicator lights green.

NOTE: A power amplifier protector is built into the repeater. The protector is activated when the repeater temperature becomes extremely high due to long periods of transmitting to reduce the transmit output power level. The output power will return to its normal level when the repeater has cooled down.

◇ Base station operation

Receiving

- ① Push **[POWER]** to turn ON the power.
- ② Set the audio and squelch levels.
 - Rotate **[SELECT]***¹ fully counterclockwise in advance.
 - Rotate **[VOLUME]** to adjust the audio output level.
 - Rotate **[SELECT]***¹ clockwise until the noise just disappears.
- ③ Push **[CH Up]***² or **[CH Down]***² to select the desired channel.
 - When receiving a signal, the **[BUSY]** indicator lights green and audio is heard from the speaker.
 - Further adjustment of **[VOLUME]** to a comfortable listening level may be necessary at this point.

*¹ When the [SQL Level Up/Down] key function is assigned to [SELECT].

*² When the [CH Up]/[CH Down] key functions are assigned.

Transmitting

- ① Take the microphone off hook.
- ② Wait for the channel to become clear.
- ③ Hold down **[PTT]** to transmit, then speak into the microphone at your normal voice level.
- ④ Release **[PTT]** to receive.

IMPORTANT:

To maximize the audio quality of the transmitted signal:

1. Pause briefly after pushing **[PTT]**.
2. Hold the microphone 5 to 10 cm (2 to 4 inch) from your mouth, then speak at your normal voice level.

■ Troubleshooting

The following chart is designed to help you correct problems that are not equipment malfunctions.

If you are unable to locate the cause of a problem or solve it through the use of this chart, contact your nearest Icom Dealer or Service Center.

PROBLEM	POSSIBLE CAUSE	SOLUTION	REF.
Power does not come on when [POWER] is pushed.	<ul style="list-style-type: none"> • DC power cable is improperly connected. • Fuse is blown. 	<ul style="list-style-type: none"> • Re-connect the DC power cable correctly. • Find the cause and repair it, then replace the fuse with a rated one. 	pp. 5, 6 p. 8
No sound comes from the speaker.	<ul style="list-style-type: none"> • Volume level is too low. • The squelch is closed. • The audio mute function is activated. • A selective call or squelch function is activated such as 5-tone call or tone squelch. • The front speaker is set to OFF. 	<ul style="list-style-type: none"> • Rotate [VOLUME] clockwise to obtain a suitable listening level. • While in the base operating mode, rotate [SELECT] to counterclockwise to open the squelch. (When the [SQL Level Up/Down] key function is assigned to [SELECT].) • Push [MONI] (if assigned) to turn the audio mute function OFF. • Turn OFF the appropriate function. • Turn ON the front speaker using the optional CS-FR5000 CLONING SOFTWARE. Ask your dealer for details. 	p. 7 p. 7 – – –
Sensitivity is low and only strong signals are audible.	<ul style="list-style-type: none"> • Antenna feedline or the antenna connector has a poor contact or is short-circuited. 	<ul style="list-style-type: none"> • Check and reconnect (or replace if necessary), the antenna feedline or antenna connector. 	p. 5
Received audio is unclear or distorted.	<ul style="list-style-type: none"> • Optional voice scrambler is turned OFF. • Scrambler code is not set correctly. 	<ul style="list-style-type: none"> • Turn ON the optional voice scrambler. • Reset the scrambler code. 	– –
Output power is too low.	<ul style="list-style-type: none"> • Output power is set to Low. • Power amplifier protection circuit is activated. 	<ul style="list-style-type: none"> • Push [HIGH/LOW] (if assigned) to select High power. • Cool down the repeater or stop accessing the repeater until it has cooled down. 	– –
No contact possible with another station.	<ul style="list-style-type: none"> • The other station is using tone squelch. • The operation mode is set to the Full-duplex mode. (Base station operation) 	<ul style="list-style-type: none"> • Turn the tone squelch function ON. • Set the operation mode to the Simplex mode, if the other station is in the Simplex mode. 	– –

■ Options

• **SP-35** EXTERNAL SPEAKER
Compact and easy-to-install.
Input impedance: 4 Ω
Rated input: 5 W
Maximum input: 7 W

• **HM-152** HAND MICROPHONE

• **SM-26** DESKTOP MICROPHONE

• **UR-FR5000/UR-FR5100/UR-FR6000/UR-FR6100**
CHANNEL EXTENSION MODULES

• **UC-FR5000** TRUNKING/NETWORK CONTROLLER

• **UT-109R** VOICE SCRAMBLER UNIT
Non-rolling type (32 codes maximum).

• **UT-110R** VOICE SCRAMBLER UNIT
Rolling type (1020 codes maximum).

▨ **NOTE:** The scrambler systems of the UT-109R and UT-110R are not compatible with each other.

Some options may not be available in some countries. Please ask your dealer for details.

INSTALLATION NOTES

• Compliance of base station transmitter installations with EN50385

The installation of this equipment and its associated antenna should be made in such a manner as to respect the EC recommended electromagnetic (EM) field exposure limits. (1999/519/EC)

In order not to exceed these exposure limits it is necessary to determine the 'Compliance Boundary,' that means the volume within which the EM field radiated by the transmitter/antenna installation may exceed the 1999/519/EC limits. You will then need to ensure that members of the general public do not have access within this area. The actual Compliance Boundary for this repeater will be totally dependant on the antenna, feeder, RF amplifier and other passive or active devices used in the installation.

The RF output power of this repeater is 25 watts.

The figures contained in this guide are based on the recommended limits for the general public and are obtained by 'worst case' numerical analysis. For a definitive evaluation of any given installation, measurements should be made with an EM field meter and a broadband calibrated probe.

• Installation

The antenna should be installed as high as possible for maximum efficiency and minimum EM field at ground-level. The evaluation of radiated field should take into account any additional RF amplifiers used, any loss in the antenna feeder cable and the gain of the antenna used as well as its polar radiation pattern.

If there are any objects or structures larger than half a wavelength close to the antenna, or within the clearance distances specified, then these can cause reflections which will have an effect on the overall radiation pattern.

For any installation you need to consider 'height clearance' (i.e. the height above any place where persons may have access) and 'front clearance' (i.e. the distance in front of the antenna where the radiated field may exceed the recommended limits). Normally with an antenna installed on a reasonably high mast or tower, there will not be any access point directly in front but care should be exercised when there are other buildings higher than the antenna within the vicinity.

• Installation with a vertical type antenna at VHF-UHF

You need to consider the distances between the antenna and any point where persons may have access. Allowing an average height of 1.8 m for a person in the vicinity of the antenna the clearance distances can be evaluated as follows. For the antenna a forward gain of 1.6 and downward gain of unity has been assumed.

Power	EIRP	Distance	Height clearance	Front clearance
1 watt	1.6 watts	0.32 m	2.1 m	0.4 m
10 watts	16 watts	1 m	2.8 m	1.3 m
25 watts	40 watts	1.6 m	3.4 m	2 m
100 watts	160 watts	3.2 m	5 m	4 m
1 kW	1600 watts	10 m	12 m	13 m

• Installation with a yagi or directive type antenna

Exposure distance assumes that the predominant radiation pattern is forwards and that radiation vertically downwards is at unity gain (sidelobe suppression is equal to main lobe gain). This is true of almost every gain antenna today. Exposed persons are assumed to be beneath the antenna array and have a typical height of 1.8 m.

The figures assume the worst case emission of constant carrier.

RF power Clearance heights by frequency band

Watts	10–2 m	70 cm	23 cm	13 cm and above
1	2.1 m	2 m	2 m	2 m
10	2.8 m	2.7 m	2.5 m	2.3 m
25	3.4 m	3.3 m	2.7 m	2.5 m
100	5 m	4.7 m	3.6 m	3.2 m
1000	12 m	11.5 m	7.3 m	6.3 m

EIRP Forward clearance, EIRP by frequency band

Watts	10–2 m	70 cm	23 cm	13 cm and above
100	2 m	2 m	1.1 m	0.7 m
1000	6.5 m	6 m	3.5 m	3 m
10,000	20 m	18 m	11 m	7 m
100,000	65 m	60 m	35 m	29 m

• Typical installation example

A UHF base station transmitter is to be installed on the roof of an office.

The transmit power is 25 watts, there is 20 m of RG-213 coaxial cable and the antenna is vertically polarised dipole.

The specification of the RG-213 cable gives a loss of 1.5 dB/10 m. There will be 3 dB loss for the 20 m length used.

The RF power at the antenna input will be 12.5 watts.

The dipole antenna has a forward gain of 0 dBd or 1.6, giving an EIRP of 20 watts.

Referring to the table above for VHF/UHF vertical antennas, this gives a front clearance distance of approx. 1.5 m and a height clearance of 3 m.

The antenna installation needs to ensure that the lowest part of the antenna is at least 3 m above any point where the general public may gain access and that they cannot pass within 1.5 m in front of the antenna.

If there is no general public access to the roof in question then the antenna could be mounted on a short stub mast. If there is such access to the roof then the antenna could be mounted on top of a short mast of 3.2 m high. The mast position should be such that the antenna can radiate clearly i.e. no other object or structure is within 1.5 m (preferably more).

It should be relatively easy to fulfil all these recommendations.

If for any reason such minimum distances are impossible to guarantee then some type of access control fence or barrier around the antenna installation should be provided.

Should a Yagi type antenna be used then you will have to obtain a 3 dimensional polar plot of the radiation characteristic from the manufacturer and evaluate the clearance distances in both vertical and horizontal planes.

• Operating Notes

All of the above comments on RF safety assume that the radio is transmitting continuously in a constant carrier mode such as FM or RTTY etc.

The RF exposure limits recommended by the EC are based on the mean power averaged over a 6 minute period.

Therefore if the total transmit time during any 6 minute period is reduced, then the installation will be even further within the recommended limits.

■ ABOUT CE AND DOC

CE Hereby, Icom Inc. declares that the versions of IC-FR5100 and IC-FR6100 which have the “CE” symbol on the product, comply with the essential requirements of the Radio Equipment Directive, 2014/53/EU, and the restriction of the use of certain hazardous substances in electrical and electronic equipment Directive, 2011/65/EU. The full text of the EU declaration of conformity is available at the following internet address:
<https://www.icomjapan.com/support/>

■ DISPOSAL



The crossed-out wheeled-bin symbol on your product, literature, or packaging reminds you that in the European Union, all electrical and electronic products, batteries, and accumulators (rechargeable batteries) must be taken to designated collection locations at the end of their working life. Do not dispose of these products as unsorted municipal waste. Dispose of them according to the laws in your area.

Count on us!

